



# *ClassPad II*

## *fx-CP400*

### *User's Guide*



CASIO Education website URL

<https://edu.casio.com>

Download Free trial software and Support software

<https://edu.casio.com/dl/>

Manuals are available in multi languages at

<https://world.casio.com/manual/calc/>

**CASIO**<sup>®</sup>

***Be sure to keep physical records of all important data!***

Low battery power or incorrect replacement of the batteries that power the ClassPad can cause the data stored in memory to be corrupted or even lost entirely. Stored data can also be affected by strong electrostatic charge or strong impact. It is up to you to keep backup copies of data to protect against its loss.

***Backing Up Data***



ClassPad data can be converted to a VCP file or XCP file and transferred to a computer for storage. For details, see “19-2 Performing Data Communication between the ClassPad and a Personal Computer”.

- Be sure to keep all user documentation handy for future reference.
- The sample screens shown in this manual are for illustrative purposes only, and may not be exactly the same as the screens actually produced by the ClassPad.
- The contents of this manual are subject to change without notice.
- No part of this manual may be reproduced in any form without the express written consent of the manufacturer.
- In no event shall CASIO Computer Co., Ltd. be liable to anyone for special, collateral, incidental, or consequential damages in connection with or arising out of the purchase or use of these materials. Moreover, CASIO Computer Co., Ltd. shall not be liable for any claim of any kind whatsoever against the use of these materials by any other party.

- Windows® is a registered trademark or trademark of Microsoft Corporation in the United States and/or other countries.
- Mac OS, OS X and macOS are registered trademarks or trademarks of Apple Inc. in the United States and/or other countries.
- Fugue © 1999 – 2012 Kyoto Software Research, Inc. All rights reserved.
- Company and product names used in this manual may be registered trademarks or trademarks of their respective owners.
- Note that trademark ™ and registered trademark ® are not used within the text of this manual.

---

# Contents

About This User's Guide .....	11
<b>Chapter 1: Basics .....</b>	<b>12</b>
<b>1-1 General Guide .....</b>	<b>12</b>
ClassPad at a Glance.....	12
Turning Power On or Off .....	13
<b>1-2 Power Supply .....</b>	<b>13</b>
<b>1-3 Built-in Application Basic Operations .....</b>	<b>14</b>
Using the Application Menu.....	14
Built-in Applications.....	14
Add-in Applications.....	15
Application Window.....	16
Using the  Menu.....	17
Interpreting Status Bar Information .....	17
Pausing and Terminating an Operation.....	17
<b>1-4 Input .....</b>	<b>18</b>
Using the Soft Keyboard .....	18
Soft Keyboard Key Sets .....	18
Input Basics.....	19
Various Soft Keyboard Operations.....	22
<b>1-5 ClassPad Data.....</b>	<b>27</b>
Data Types and Storage Locations (Memory Areas) .....	27
Main Memory Data Types .....	28
Main Memory Folders.....	28
Using Variable Manager.....	29
Managing Application Files .....	32
<b>1-6 Creating and Using Variables .....</b>	<b>33</b>
Creating a New Variable .....	33
Variable Usage Example.....	34
“library” Folder Variables.....	34
Rules Governing Variable Access.....	35
<b>1-7 Configuring Application Format Settings.....</b>	<b>36</b>
Application Format Settings .....	36
Initializing All Application Format Settings.....	42
<b>1-8 When you keep having problems... ..</b>	<b>43</b>
<b>Chapter 2: Main Application .....</b>	<b>44</b>
Main Application-Specific Menus and Buttons .....	44
<b>2-1 Basic Calculations.....</b>	<b>44</b>
Arithmetic Calculations and Parentheses Calculations .....	44
Using the  Key.....	45
Omitting the Multiplication Sign.....	45
Using the Answer Variable (ans).....	45
Assigning a Value to a Variable .....	45
Calculation Priority Sequence .....	46
Calculation Modes.....	46
<b>2-2 Using the Calculation History.....</b>	<b>48</b>
<b>2-3 Function Calculations .....</b>	<b>48</b>
<b>2-4 List Calculations .....</b>	<b>57</b>
Inputting List Data in the Work Area.....	57
LIST Variable Element Operations.....	57

Using a List in a Calculation .....	57
Using a List to Assign Different Values to Multiple Variables .....	57
<b>2-5 Matrix and Vector Calculations .....</b>	<b>58</b>
Inputting Matrix Data .....	58
Performing Matrix Calculations .....	58
Using a Matrix to Assign Different Values to Multiple Variables .....	59
<b>2-6 Specifying a Number Base .....</b>	<b>59</b>
Binary, Octal, Decimal, and Hexadecimal Calculation Ranges .....	59
Selecting a Number Base .....	60
Arithmetic Operations .....	60
Bitwise Operations .....	60
Using the baseConvert Function (Number System Transform) .....	61
<b>2-7 Using the Action Menu .....</b>	<b>61</b>
Abbreviations and Punctuation Used in This Section .....	61
Example Screenshots .....	62
Using the Transformation Submenu .....	62
Using the Advanced Submenu .....	64
Using the Calculation Submenu .....	67
Using the Complex Submenu .....	70
Using the List-Create Submenu .....	71
Using the List-Statistics and List-Calculation Submenus .....	72
Using the Matrix-Create Submenu .....	75
Using the Matrix-Calculation and Matrix-Row&Column Submenus .....	76
Using the Vector Submenu .....	79
Using the Equation/Inequality Submenu .....	81
Using the Assistant Submenu .....	84
Using the Distribution/Inv.Dist Submenu .....	85
Using the Financial Submenu .....	90
Using the Command Submenu .....	90
<b>2-8 Using the Interactive Menu .....</b>	<b>91</b>
Interactive Menu Example .....	91
Using the “apply” Command .....	91
<b>2-9 Using the Main Application in Combination with Other Applications .....</b>	<b>92</b>
Using Another Application’s Window .....	92
Using the Stat Editor Window .....	93
Using the Geometry Window .....	93
<b>2-10 Using Verify .....</b>	<b>94</b>
<b>2-11 Using Probability .....</b>	<b>95</b>
<b>2-12 Running a Program in the Main Application .....</b>	<b>96</b>
<b>Chapter 3: Graph &amp; Table Application .....</b>	<b>97</b>
Graph & Table Application-Specific Menus and Buttons .....	97
<b>3-1 Storing Functions .....</b>	<b>99</b>
Using Graph Editor Sheets .....	99
Storing a Function .....	99
Graphing a Stored Function .....	100
Shading the Region Bounded by Two Expressions .....	101
Overlaying Two Inequalities in an Intersection Plot / Union Plot .....	101
Saving Graph Editor Data to Graph Memory .....	102
<b>3-2 Using the Graph Window .....</b>	<b>102</b>
Configuring View Window Parameters for the Graph Window .....	102
Using View Window Memory .....	104
Panning the Graph Window .....	104

Scrolling the Graph Window.....	105
Zooming the Graph Window.....	105
Using Quick Zoom.....	106
Using Built-in Functions for Graphing.....	106
Saving a Screenshot of a Graph .....	107
Adjusting the Lightness (Fade I/O) of the Graph Window Background Image.....	107
<b>3-3 Using Table &amp; Graph.....</b>	<b>108</b>
Generating a Number Table.....	108
Showing Linked Displays of Number Table Coordinates and Graph Coordinates (Link Trace).....	109
Generating Number Table Values from a Graph.....	110
Generating a Summary Table .....	110
<b>3-4 Using Trace .....</b>	<b>111</b>
Using Trace to Read Graph Coordinates.....	111
<b>3-5 Using the Sketch Menu .....</b>	<b>112</b>
Using Sketch Menu Commands.....	112
<b>3-6 Analyzing a Function Used to Draw a Graph .....</b>	<b>114</b>
What You Can Do Using the G-Solve Menu Commands.....	114
Using G-Solve Menu Commands.....	114
<b>3-7 Modifying a Graph .....</b>	<b>115</b>
Modifying a Single Graph (Direct Modify).....	115
Modifying Multiple Graphs Simultaneously (Dynamic Modify) .....	115
<b>Chapter 4: Conics Application .....</b>	<b>118</b>
Conics Application-Specific Menus and Buttons.....	118
<b>4-1 Inputting an Equation.....</b>	<b>119</b>
<b>4-2 Drawing a Conics Graph .....</b>	<b>119</b>
Drawing a Parabola.....	119
Drawing a Circle .....	120
Drawing an Ellipse.....	120
Drawing a Hyperbola.....	120
Drawing a General Conics .....	120
<b>4-3 Using G-Solve to Analyze a Conics Graph.....</b>	<b>120</b>
What You Can Do Using the G-Solve Menu Commands.....	120
Using G-Solve Menu Commands.....	121
<b>4-4 Modifying a Graph (Dynamic Modify) .....</b>	<b>121</b>
<b>Chapter 5: Differential Equation Graph Application.....</b>	<b>122</b>
Differential Equation Editor Window-Specific Menus and Buttons.....	122
Differential Equation Graph Window-Specific Menus and Buttons .....	122
<b>5-1 Graphing a Differential Equation.....</b>	<b>123</b>
Graphing a First Order Differential Equation .....	123
Graphing a Second Order Differential Equation.....	124
Graphing an Nth-order Differential Equation .....	124
Configuring and Modifying Initial Conditions .....	125
Configuring Differential Equation Graph View Window Parameters .....	126
<b>5-2 Drawing <math>f(x)</math> Type Function Graphs and Parametric Function Graphs.....</b>	<b>127</b>
<b>5-3 Using Trace to Read Graph Coordinates.....</b>	<b>127</b>
<b>5-4 Graphing an Expression or Value by Dropping It into the Differential Equation Graph Window .....</b>	<b>128</b>
<b>Chapter 6: Sequence Application .....</b>	<b>129</b>
Sequence Application-Specific Menus and Buttons.....	129
<b>6-1 Recursive and Explicit Form of a Sequence .....</b>	<b>130</b>
Generating a Number Table.....	130

Determining the General Term of a Recursion Expression.....	131
Calculating the Sum of a Sequence.....	131
<b>6-2 Graphing a Recursion .....</b>	<b>131</b>
<b>Chapter 7: Statistics Application .....</b>	<b>132</b>
<b>7-1 Using Stat Editor.....</b>	<b>132</b>
Basic List Operations .....	132
Menus and Buttons Used for List Editing .....	133
Using CSV Files .....	134
<b>7-2 Drawing a Statistical Graph .....</b>	<b>135</b>
Operation Flow Up to Statistical Graphing .....	135
Graphing Single-Variable Statistical Data .....	136
Graphing Paired-Variable Statistical Data.....	137
Overlaying a Regression Graph on a Scatter Plot .....	139
Overlaying a Function Graph on a Statistical Graph.....	140
Stat Graph Window Menus and Buttons .....	140
<b>7-3 Performing Basic Statistical Calculations.....</b>	<b>141</b>
Calculating Statistical Values .....	141
Performing Regression Calculations.....	143
Viewing the Results of the Last Statistical Calculation Performed (DispStat) .....	145
<b>7-4 Performing Advanced Statistical Calculations .....</b>	<b>145</b>
Performing Test, Confidence Interval and Distribution Calculations Using the Wizard.....	145
Tests.....	146
Confidence Intervals.....	149
Distributions.....	151
Input and Output Terms .....	154
<b>Chapter 8: Geometry Application .....</b>	<b>156</b>
Geometry Application-Specific Menus and Buttons .....	156
Configuring Geometry View Window Settings.....	157
About the Geometry Format Dialog Box .....	157
<b>8-1 Drawing Figures.....</b>	<b>157</b>
Drawing a Figure.....	157
Inserting Text Strings into the Screen .....	161
Attaching an Angle Measurement to a Figure .....	161
Displaying the Measurements of a Figure.....	161
Displaying the Result of a Calculation that Uses On-screen Measurement Values.....	162
Using the Special Polygon Submenu .....	162
Using the Construct Submenu .....	163
<b>8-2 Editing Figures.....</b>	<b>167</b>
Selecting and Deselecting Figures.....	167
Moving and Copying Figures.....	168
Pinning an Annotation on the Geometry Window.....	168
Specifying the Number Format of a Measurement.....	168
Specifying the Color and Line Type of a Displayed Object .....	169
Changing the Display Priority of Objects.....	169
<b>8-3 Using the Measurement Box .....</b>	<b>170</b>
Viewing the Measurements of a Figure.....	170
Specifying and Constraining a Measurement of a Figure .....	171
Using Sliders .....	172
Changing a Label or Adding a Name to an Element.....	174
<b>8-4 Working with Animations .....</b>	<b>174</b>
Using Animation Commands.....	174

<b>8-5 Using the Geometry Application with Other Applications .....</b>	<b>177</b>
Drag and Drop .....	177
Copy and Paste .....	177
<b>Chapter 9: Numeric Solver Application .....</b>	<b>178</b>
Numeric Solver Application-Specific Menus and Buttons .....	178
Inputting an Equation .....	178
Solving an Equation .....	178
<b>Chapter 10: eActivity Application .....</b>	<b>180</b>
eActivity Application-Specific Menus and Buttons .....	180
<b>10-1 Creating an eActivity .....</b>	<b>180</b>
Basic Steps for Creating an eActivity .....	180
Inserting Data into an eActivity .....	181
Inserting an Application Data Strip .....	182
Inserting a Geometry Link Row .....	184
<b>10-2 Transferring eActivity Files .....</b>	<b>185</b>
File Compatibility .....	185
Transferring eActivity Files between a ClassPad Unit and a Computer .....	185
Transferring eActivity Files between Two ClassPad Units .....	185
<b>Chapter 11: Financial Application .....</b>	<b>186</b>
<b>11-1 Financial Application Basic Operations .....</b>	<b>186</b>
Page Operations .....	187
Configuring Financial Application Settings .....	188
<b>11-2 Performing Financial Calculations .....</b>	<b>189</b>
<b>11-3 Calculation Formulas .....</b>	<b>189</b>
Simple Interest .....	189
Compound Interest .....	190
Cash Flow .....	190
Amortization .....	191
Interest Conversion .....	191
Cost/Sell/Margin .....	192
Depreciation .....	192
Bond Calculation .....	192
Break-Even Point .....	193
Margin of Safety .....	193
Financial Leverage .....	193
Operating Leverage .....	193
Combined Leverage .....	193
Quantity Conversion .....	193
<b>11-4 Financial Calculation Functions .....</b>	<b>194</b>
<b>11-5 Input and Output Field Names .....</b>	<b>195</b>
<b>Chapter 12: Program Application .....</b>	<b>196</b>
Program Application-Specific Menus and Buttons .....	196
<b>12-1 Creating and Running Program .....</b>	<b>197</b>
Creating a Program .....	197
Running a Program .....	199
Terminating Program Execution .....	200
Creating a Text File .....	200
Using Text Files .....	201
Converting a Text File to a Program File .....	201
Converting a Program File to an Executable File .....	201

<b>12-2 Debugging a Program .....</b>	<b>202</b>
Debugging After an Error Message Appears .....	202
Debugging a Program Following Unexpected Results.....	202
Editing a Program.....	202
<b>12-3 User-defined Functions.....</b>	<b>203</b>
Creating a New User-defined Function .....	203
Executing a User-defined Function .....	204
Editing a User-defined Function .....	204
<b>12-4 Program Command Reference .....</b>	<b>205</b>
Using This Reference.....	205
Syntax Conventions .....	205
Command List .....	206
<b>12-5 Including ClassPad Functions in Programs .....</b>	<b>225</b>
Including Graphing Functions in a Program .....	225
Including Table & Graph Functions in a Program .....	225
Including Recursion Table and Recursion Graph Functions in a Program .....	225
Including Statistical Graphing and Calculation Functions in a Program.....	225
Including Financial Calculation Functions in a Program.....	225
<b>Chapter 13: Spreadsheet Application.....</b>	<b>226</b>
Spreadsheet Window-Specific Menus and Buttons .....	226
Changing the Width of a Column .....	227
Option Settings.....	228
<b>13-1 Inputting and Editing Cell Contents.....</b>	<b>228</b>
Selecting Cells.....	228
Inputting Data into a Cell .....	229
Inputting a Formula .....	229
Inputting a Cell Reference.....	230
Cell Data Types (Text Data and Calculation Data) .....	231
Inputting a Constant into a Calculation Data Type Cell.....	231
Using the Cell Viewer Window .....	233
Changing the Text Color and Fill Color of Specific Cells.....	233
Copying or Cutting Cells and Pasting Them to Another Location .....	234
Recalculating Spreadsheet Expressions.....	234
Transferring Data between a Spreadsheet and CSV Files .....	235
Importing and Exporting Variable Values .....	235
<b>13-2 Graphing.....</b>	<b>237</b>
Basic Graphing Steps .....	237
Column Series and Row Series .....	237
Graph Colors and Color Link.....	238
Spreadsheet Graph Window-Specific Menus and Buttons .....	239
Graph Menu and Graph Examples.....	239
Regression Graph Operations (Curve Fitting).....	242
Other Graph Window Operations .....	243
<b>13-3 Statistical Calculations .....</b>	<b>244</b>
Single-variable, Paired-variable and Regression Calculations.....	245
Test and Interval Calculations .....	246
Distribution Calculations.....	248
About DispStat Command.....	248
<b>13-4 Cell and List Calculations .....</b>	<b>249</b>
Using the Cell Calculation Functions.....	249
Using the List Calculation Functions .....	249







<b>Chapter 14: 3D Graph Application</b> .....	<b>250</b>
3D Graph Application-Specific Menus and Buttons .....	250
<b>14-1 Inputting an Expression</b> .....	<b>251</b>
Using 3D Graph Editor Sheets .....	251
Storing a Function .....	251
Graphing a Stored Function .....	252
<b>14-2 Using the 3D Graph Window</b> .....	<b>253</b>
Configuring 3D Graph View Window Parameters .....	253
Showing and Hiding Axes and Labels .....	254
Rotating the Graph .....	255
3D Graph Example .....	255
Using Trace to Read Graph Coordinates .....	255
Inserting Text into a 3D Graph Window .....	256
Calculating a $z$ -value for Particular $x$ - and $y$ -values, or $s$ - and $t$ -values .....	256
<b>Chapter 15: Picture Plot Application</b> .....	<b>257</b>
Picture Plot Application-Specific Menus and Buttons .....	258
<b>15-1 Using the Plot Function</b> .....	<b>259</b>
Starting a Picture Plot Operation .....	259
Plotting Points on a c2p File Image .....	259
Plotting Points on a c2b File Image .....	260
Editing Plots on a Background Image .....	261
Overlaying a Graph on Background Image Plots .....	261
G-Solve .....	263
Scrolling the Picture Plot Window .....	263
<b>15-2 Using the Plot List</b> .....	<b>264</b>
Using the Plot List Window to Edit Plots .....	264
Saving Data to and Importing Data from a Spreadsheet .....	264
Exporting Plot Data to and Importing Plot Data from a Variable .....	265
<b>15-3 Displaying Plots on <math>t</math>-<math>y</math> or <math>t</math>-<math>x</math> Coordinates</b> .....	<b>265</b>
<b>15-4 Picture Plot Application Files</b> .....	<b>266</b>
<b>Chapter 16: Interactive Differential Calculus Application</b> .....	<b>267</b>
DiffCalc Table Window-Specific Menus and Buttons .....	267
<b>16-1 Learning about Tangents Using the [Tangent] Tab</b> .....	<b>268</b>
<b>16-2 Deriving the Derivative Using the [Deriv] Tab</b> .....	<b>269</b>
<b>16-3 Generating a Number Table and Graphing the First Derivative and Second Derivative Using the [D Trace] Tab</b> .....	<b>271</b>
<b>Chapter 17: Physium Application</b> .....	<b>273</b>
Physium Application Menus and Buttons .....	273
<b>17-1 Periodic Table</b> .....	<b>274</b>
<b>17-2 Fundamental Physical Constants</b> .....	<b>275</b>
<b>17-3 Precautions</b> .....	<b>277</b>
<b>Chapter 18: System Application</b> .....	<b>279</b>
<b>18-1 Managing Memory Usage</b> .....	<b>279</b>
Using the Storage Sheet .....	279
Using the Main Memory Sheet and eActivity Sheet .....	280
<b>18-2 Configuring System Settings</b> .....	<b>281</b>
System Application Menus and Buttons .....	281
Configuring System Settings .....	281

<b>Chapter 19: Performing Data Communication</b> .....	<b>285</b>
<b>19-1 Data Communication Overview</b> .....	<b>285</b>
Using the ClassPad Communication Application .....	285
Select Connection Mode Dialog Box.....	286
<b>19-2 Performing Data Communication between the ClassPad and a Personal Computer</b> ..	<b>286</b>
Connecting and Disconnecting with a Computer in the USB Flash Mode .....	287
Transferring Data between the ClassPad and a Personal Computer .....	288
Installing an Add-in Application .....	289
Auto Import of VCP Files.....	289
Rules for ClassPad Files and Folders.....	289
VCP and XCP File Operations .....	289
<b>19-3 Performing Data Communication between Two ClassPads</b> .....	<b>291</b>
Connecting to Another ClassPad Unit.....	291
Transferring Data between Two ClassPads.....	291
Communication Standby .....	293
Interrupting an Ongoing Data Communication Operation .....	293
<b>19-4 Connecting the ClassPad to a Data Logger</b> .....	<b>293</b>
Connecting a ClassPad to a Data Logger.....	293
<b>19-5 Connecting the ClassPad to a Projector</b> .....	<b>294</b>
Projecting ClassPad Screen Contents from a Projector.....	294
Precautions when Connecting.....	294
<b>Appendix</b> .....	<b>295</b>
<b>Character Code Table</b> .....	<b>295</b>
<b>System Variable Table</b> .....	<b>299</b>
<b>Graph Types and Executable Functions</b> .....	<b>302</b>
<b>Error and Warning Message Tables</b> .....	<b>303</b>
Error Message Table .....	303
Warning Message Table .....	307
Low Memory Error Processing.....	307
<b>Resetting and Initializing the ClassPad</b> .....	<b>307</b>
<b>Number of Digits and Precision</b> .....	<b>308</b>
Number of Digits.....	308
Precision.....	308
<b>Display Brightness and Battery Life</b> .....	<b>309</b>
Display Brightness.....	309
Battery Life .....	309
<b>Specifications</b> .....	<b>309</b>
<b>Exam Mode</b> .....	<b>311</b>
Communication Application - Exam Mode Menu .....	311
Entering the Exam Mode.....	311
ClassPad Operation in the Exam Mode .....	312
Exiting the Exam Mode .....	313
Displaying Exam Mode Help .....	314

---

## About This User's Guide

- The four digit boldface example numbers (such as **0201**) that appear in Chapters 2 through 14 indicate operation examples that can be found in the separate "Examples" booklet. You can use the "Examples" booklet in conjunction with this manual by referring to the applicable example numbers.
- In this manual, cursor key operations are indicated as , , ,  (1-1 General Guide).

# Chapter 1: Basics

This chapter provides a general overview of the ClassPad and application operations, as well as information about input operations, the handling of data (variables and folders), file operations, and how to configure application format settings.

## 1-1 General Guide

### ClassPad at a Glance

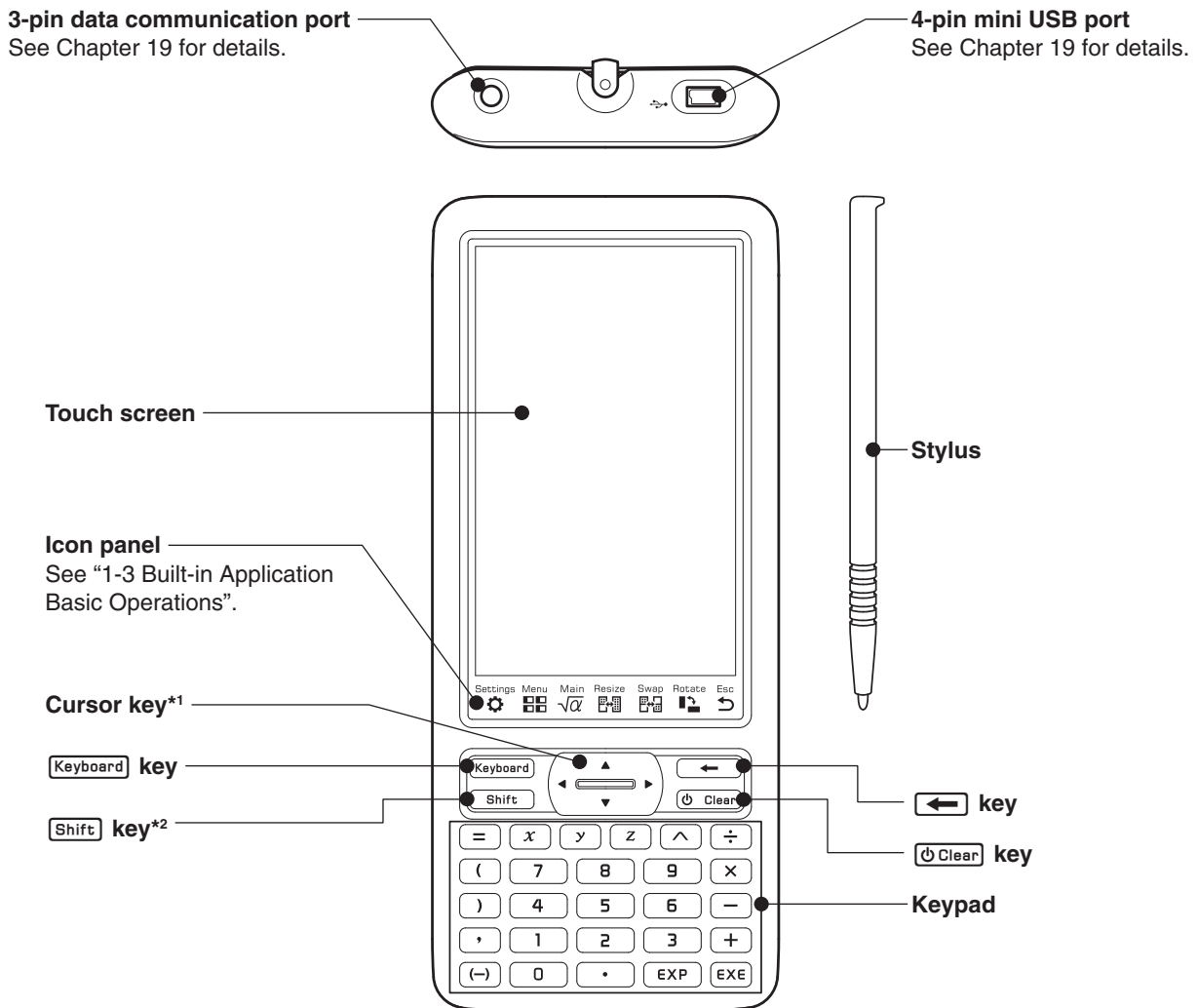

\*1 In this manual, cursor key operations are indicated as  $\blacktriangle$ ,  $\blacktriangledown$ ,  $\blacktriangleleft$ ,  $\blacktriangleright$ .

\*2 Certain functions (cut, paste, undo, etc.) or key input operations can be assigned to key combinations that consist of pressing the **Shift** key and a keypad key. For more information, see "18-2 Configuring System Settings".

---

## Turning Power On or Off

While the ClassPad is turned off, press **[Clear]** to turn it on.

To turn off the ClassPad, press **[Shift]** and then **[Clear]**.

### Auto Power Off

The ClassPad also has an Auto Power Off feature. This feature automatically turns the ClassPad off when it is idle for a specified amount of time. For details, see “To configure power properties” on page 282.

### Note

Any temporary information in ClassPad RAM (graphs drawn on an application’s graph window, a dialog box displayed, etc.) is retained for approximately 30 seconds whenever power is turned off manually or by Auto Power Off. This means you will be able to restore the temporary information in RAM if you turn ClassPad back on within about 30 seconds after it is turned off. After about 30 seconds, the temporary information in RAM is cleared automatically, so turning ClassPad back on will display the startup screen of the application you were using when you last turned it off, and the previous information in RAM will no longer be available.



## 1-2 Power Supply

Your ClassPad is powered by four AAA-size batteries LR03 (AM4), or four nickel-metal hydride batteries.

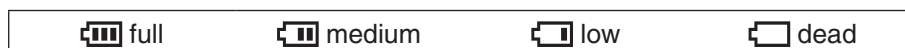
The battery level indicator is displayed in the status bar.



### Important!

- Be sure to replace batteries as soon as possible whenever the battery level indicator shows  (low).
- Replace batteries immediately whenever the battery level indicator shows  (dead). At this level, you will not be able to perform data communication or other functions.
- For information about initial setup operations required after replacing batteries, see “Loading Batteries and Setting Up the ClassPad” in the separate Quick Start Guide.
- When battery power is very low, your ClassPad may not turn back on when you press its **[Clear]** key. If this happens, immediately replace its batteries.
- The following message indicates that batteries are about to go dead. Replace batteries immediately whenever this message appears.



If you try to continue using the ClassPad, it will automatically turn off. You will not be able to turn power back on until you replace batteries.

- Be sure to replace batteries at least once a year, no matter how much you use the ClassPad during that time.

**Note:** The batteries that come with the ClassPad discharge slightly during shipment and storage. Because of this, they may require replacement sooner than the normal expected battery life.

### Backing Up Data

ClassPad data can be converted to a VCP file or XCP file and transferred to a computer for storage. For details, see “19-2 Performing Data Communication between the ClassPad and a Personal Computer”.

# 1-3 Built-in Application Basic Operations

This section explains basic information and operations that are common to all of the built-in applications.

## Using the Application Menu

Tapping  on the icon panel displays the application menu. You can perform the operations below with the application menu.

Tap a button to start up an application. See “Built-in Applications” below.

Tapping here scrolls between application menu pages. The application menu page can also be changed by swiping the screen left or right with the stylus or your finger.

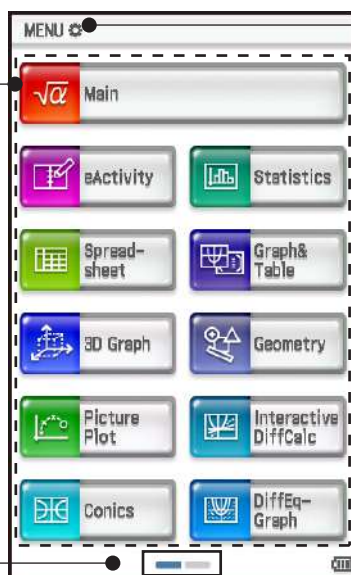

Tap here (or tap  on the icon panel) to display the next menu.

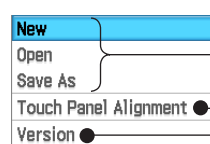







VCP file operations. See page 289.











Starts touch panel alignment. See page 284.

Displays version information. See page 284.

## Built-in Applications

The table below shows the application icons displayed on the application menu, and explains what you can do with each application.

Tap this icon:	To start this application:	To perform this type of operation:
	Main	<ul style="list-style-type: none"> <li>• General calculations, including function calculations</li> <li>• Matrix calculations</li> <li>• Computer Algebra System</li> </ul>
	eActivity	<ul style="list-style-type: none"> <li>• Create an eActivity file that can be used for input of formulas, text, and other ClassPad application data</li> </ul>
	Statistics	<ul style="list-style-type: none"> <li>• Create a list</li> <li>• Perform statistical calculations</li> <li>• Draw a statistical graph</li> </ul>
	Spreadsheet	<ul style="list-style-type: none"> <li>• Input data into a spreadsheet</li> <li>• Manipulate and/or graph spreadsheet data</li> <li>• Perform statistical calculations and/or draw a statistical graph</li> </ul>
	Graph & Table	<ul style="list-style-type: none"> <li>• Draw a graph</li> <li>• Register a function and create a table of solutions by substituting different values for the function’s variables</li> </ul>
	3D Graph	<ul style="list-style-type: none"> <li>• Draw a 3-dimensional graph of an equation in the form <math>z = f(x, y)</math> or of a parametric equation</li> </ul>
	Geometry	<ul style="list-style-type: none"> <li>• Draw geometric figures</li> <li>• Build animated figures</li> </ul>

Tap this icon:	To start this application:	To perform this type of operation:
	Picture Plot	<ul style="list-style-type: none"> <li>Plot points (that represent coordinates) on a photograph, illustration, or other graphic and perform various types of analysis based on the plotted data (coordinate values)</li> </ul>
	Interactive Differential Calculus	<ul style="list-style-type: none"> <li>Learn about the differential coefficients and/or derivative formulas that are the foundation of differentiation</li> </ul>
	Conics	<ul style="list-style-type: none"> <li>Draw the graph of a conics section</li> </ul>
	Differential Equation Graph	<ul style="list-style-type: none"> <li>Draw vector fields and solution curves to explore differential equations</li> </ul>
	Numeric Solver	<ul style="list-style-type: none"> <li>Obtain the value of any variable in an equation, without transforming or simplifying the equation</li> </ul>
	Sequence	<ul style="list-style-type: none"> <li>Perform sequence calculations</li> <li>Solve recursion expressions</li> </ul>
	Financial	<ul style="list-style-type: none"> <li>Perform simple interest, compound interest, and other financial calculations</li> </ul>
	Program	<ul style="list-style-type: none"> <li>Input a program or run a program</li> <li>Create a user-defined function</li> </ul>
	E-CON3	<ul style="list-style-type: none"> <li>Control the optionally available Data Logger (See the separate E-CON3 User's Guide.)</li> </ul>
	Communication	<ul style="list-style-type: none"> <li>Exchange data with another ClassPad, a computer, or another device</li> </ul>
	System	<ul style="list-style-type: none"> <li>Manage ClassPad memory (main memory, eActivity area, storage area)</li> <li>Configure system settings</li> </ul>

**Tip:** You can also start up the Main application by tapping  $\sqrt{\alpha}$  on the icon panel.

## Add-in Applications

You can download add-in applications (as c2a files) from the CASIO website, install them on your ClassPad, and use them the same way you use built-in applications. The table below shows the add-in applications that are currently available.

Icon	Application	Description
	Physium	<ul style="list-style-type: none"> <li>Find elements and display the atomic number, chemical symbol, atomic weight and other information from the periodic table of elements</li> <li>Display various physical constants</li> </ul>

### Note

You can delete all add-in applications using one of the procedures below.

- Reset - Storage Memory or Reset - All ("To batch delete specific data (Reset)", page 281)
- Initialize ("To initialize your ClassPad", page 282)

After deleting add-in applications, you can use the procedure under "Installing an Add-in Application" (page 289) to re-install them.



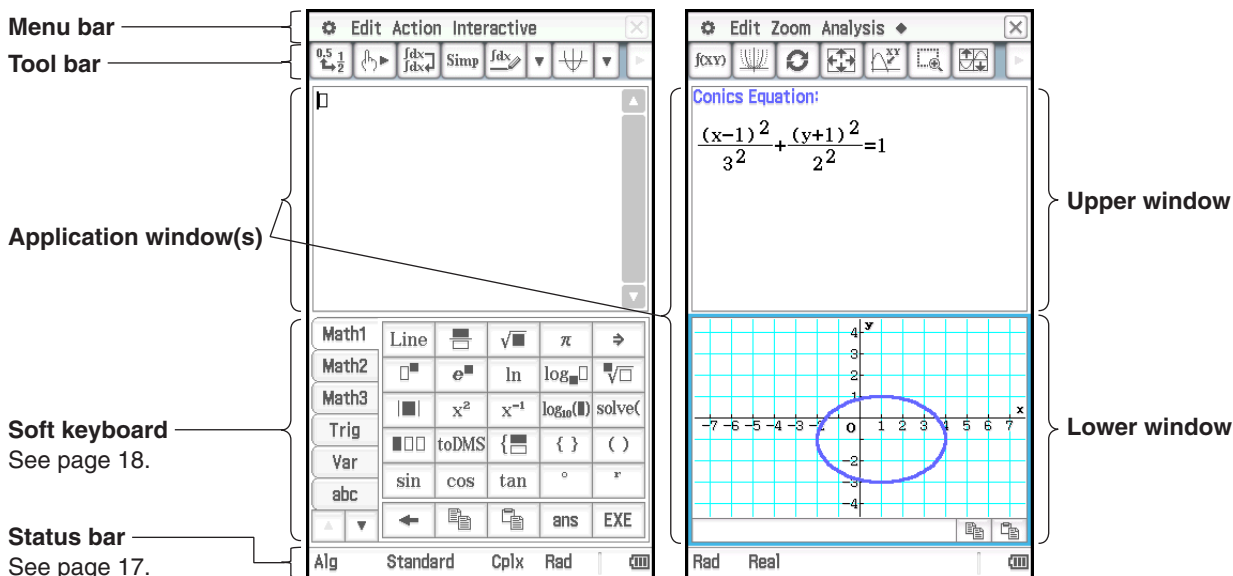

## Application Window



The following shows the basic configuration of a built-in application window.





Many applications split the display between an upper window and a lower window, each of which shows different information. When using two windows, the currently selected window (the one where you can perform operations) is called the “active window”. The menu bar, toolbar, and status bar contents are all applicable to the active window. The active window is indicated by a thick boundary around it.

You can perform the operations below on an Application window.

To do this:	Perform this operation:
Switch the active window	While a dual window is on the display, tap anywhere inside the window that does not have a thick boundary around it to make it the active window. Note that you cannot switch the active window while an operation is being performed in the current active window.
Resize the active window so it fills the display	While a dual window is on the display, tap  . This causes the active window to fill the display. To return to the dual window display, tap  again.
Swap the upper and lower windows	While a dual window is on the display, tap  . This causes the upper window to become the lower window, and vice versa. Swapping windows does not have any effect on their active status. If the upper window is active when you tap  for example, that window will remain active after it becomes the lower window.
Close the active windows	While a dual window is on the display, tap  at the top right corner of the window to close the active window. This will cause the other (inactive) window to fill the display.

**Tip:** When you tap the  icon while a dual window is on the display, the currently active window will fill the display, but the other (inactive) window does not close. It remains open, hidden behind the active window. This means you can tap  to bring the hidden window forward and make it the active window, and send the current active window to the background.





### • Changing the Display Orientation (Application Menu and Some Applications Only)

You can change the display orientation to horizontal while any one of the following is displayed: application menu, or the Main, Graph & Table, Conics, or Physium application. Tap  to switch to horizontal (landscape) display orientation. To return to vertical (portrait) display orientation, tap  again.



---

## Using the Menu

The  menu appears at the top left of the window of each application, except for the System application. You can access the  menu by tapping  on the icon panel, or by tapping the menu bar's  menu.

The following describes all of the items that appear on the  menu.

- ① Tapping [Variable Manager] starts up Variable Manager. See “Using Variable Manager” (page 29) for details.
- ② Tapping [View Window] displays a dialog box for configuring the display range and other graph settings. For details, see the explanations for the various applications with graphing capabilities (Graph & Table, Differential Equation Graph, Statistics, etc.)
- ③ Tapping a menu selection displays a dialog box for configuring the corresponding setup settings. See “1-7 Configuring Application Format Settings” for details.
- ④ Tapping [Default Setup] returns all settings to their initial defaults (except for the current folder setting). See “1-7 Configuring Application Format Settings” for details.
- ⑤ Tapping [Window] displays a list of all of the windows that can be accessed from the current application (Statistics application in this example). Tapping a menu selection displays the corresponding window and makes it active.
- ⑥ Tap [Keyboard] to toggle display of the soft keyboard on or off.
- ⑦ Tapping [Close] closes the currently active window, except in the following cases.
  - When only one window is on the display
  - When the currently active window cannot be closed by the application being usedYou cannot, for example, close the Graph Editor window from the Graph & Table application.

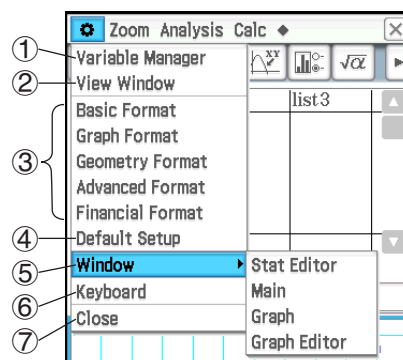

---

## Interpreting Status Bar Information

The status bar appears along the bottom of the window of each application.

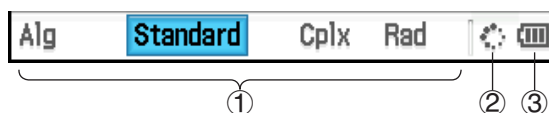



- ① Information about the currently running application  
You can change the configuration of a setting indicated in the status bar by tapping it. Tapping “Cplx” (indicating complex number calculations) while the Main application is running will toggle the setting to “Real” (indicating real number calculations). Tapping again will toggle back to “Cplx”. For more details about the current application information, see “1-7 Configuring Application Format Settings”.
- ② This indicator rotates while processing in progress.  
 appears here to indicate when an operation is paused.
- ③ Battery level indicator (See “1-2 Power Supply”).

---

## Pausing and Terminating an Operation

Many of the built-in applications provide operations to pause and terminate (break) expression processing, graphing, and other operations.

### • To pause an operation

Pressing the  key while an expression processing, graphing, or other operation is being performed pauses the operation.  appears on the right side of the status bar to indicate when an operation is paused. Pressing  again resumes the operation.

• **To terminate an operation**

Pressing the **Clear** key while an expression processing, graphing, or other operation is being performed terminates the operation and displays a “Break” dialog box like the one shown nearby.

Tap the [OK] button on the dialog box to exit the Break state.



## 1-4 Input

You can input data on the ClassPad using its keypad or by using the on-screen soft keyboard.

Virtually all data input required by your ClassPad can be performed using the soft keyboard. The keypad keys are used for input of frequently used data like numbers, arithmetic operators, etc.

### Using the Soft Keyboard

The soft keyboard is displayed in the lower part of the touch screen.

• **To display the soft keyboard**

When the soft keyboard is not on the touch screen, press the **Keyboard** key, or tap the **Settings** menu and then tap [Keyboard]. This causes the soft keyboard to appear.

- The soft keyboard has a number of different key sets such as [Math1], [abc], and [Catalog], which you can use to input of functions and text. To select a key set, tap one of the tabs along the left side of the soft keyboard.
- Pressing the **Keyboard** key or tapping the **Settings** menu, and then [Keyboard] again hides the soft keyboard.

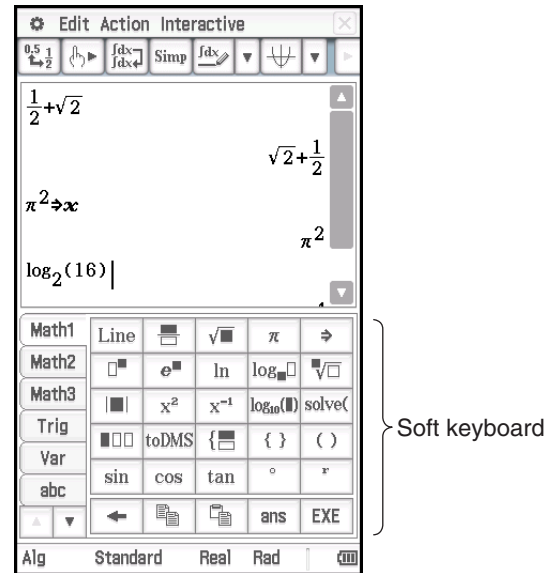

### Soft Keyboard Key Sets

The soft keyboard has a variety of different key sets that support various data input needs. Each of the available key sets is shown below.

**[Math1], [Math2], [Math3], [Trig] (trigonometric), [Advance] key sets**

These key sets include keys for inputting functions, operators, and symbols required for numerical formulas.

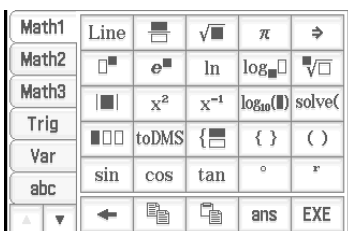

**Math1**

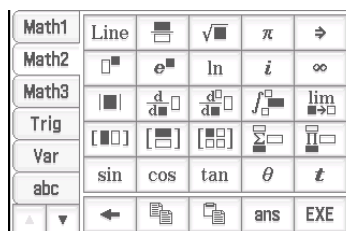

**Math2**

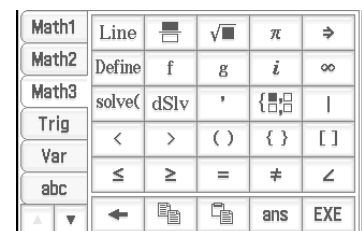

**Math3**

Math1	Line	$\frac{\square}{\square}$	$\sqrt{\square}$	$\pi$	$\rightarrow$
Math2	sin	cos	tan	$i$	$\infty$
Math3	$\sin^{-1}$	$\cos^{-1}$	$\tan^{-1}$	$\theta$	$\int$
Trig	sinh	cosh	tanh	$^{\circ}$	$^{\circ}$
Var	$\sinh^{-1}$	$\cosh^{-1}$	$\tanh^{-1}$	$\square^{\square}$	
abc					
	$\leftarrow$	$\leftarrow$	$\leftarrow$	ans	EXE

Trig

Catalog	Line	int	!	nPr	nCr
Advance	$a_n$	$b_n$	$c_n$	rSlv	
Number	+1	+2	n		
	$F_{\square}$	$F_{\square}^{-1}$	$L_{\square}$	$L_{\square}^{-1}$	$\Gamma_{\square}$
	$\delta_{\square}$	$\delta_{\square}^{\square}$	$H_{\square}$		
	$\leftarrow$	$\leftarrow$	$\leftarrow$	ans	EXE

Advance

For details above the above key sets, see “Using Math, Trig, and Advance Key Sets” (page 23).

### [Var] (variable) key set

This key set includes only keys for the input of single-character variables. For more information, see “Using Single-character Variables” (page 25).

Math1	$a$	$b$	$c$	$d$	$e$	$f$
Math2	$g$	$h$	$i$	$j$	$k$	$l$
Math3	$m$	$n$	$o$	$p$	$q$	$r$
Trig	$s$	$t$	$u$	$v$	$w$	$x$
Var	$y$	$z$			$\rightarrow$	CAPS
abc						
	$\leftarrow$	$\leftarrow$	$\leftarrow$	ans	EXE	

### [abc] key set

Use this key set to input alphabetic characters. Tap one of the tabs along the top of the keyboard (along the right when using horizontal display orientation) to see additional characters, for example, tap [Math]. For more information, see “Using the Alphabet Keyboard” (page 26).

abc	$\alpha\beta\gamma$	Math	Symbol							
1	2	3	4	5	6	7	8	9	0	-
q	w	e	r	t	y	u	i	o	p	@
a	s	d	f	g	h	j	k	l	;	:
$\uparrow$	z	x	c	v	b	n	m	,	.	CAPS
	$\leftarrow$	$\leftarrow$	$\leftarrow$	$\leftarrow$	$\leftarrow$	$\leftarrow$	$\leftarrow$	Space	EXE	

### [Catalog] key set

This key set provides a scrollable list that can be used to input built-in functions, built-in commands, system variables, and user-defined functions. Tap a command to select it and then tap it again to insert it. Selecting an item from the Form list changes the available commands. For more information, see “Using the Catalog Keyboard” (page 27).

Catalog	$\leftarrow$	A	B	C	D	E	F	$\rightarrow$
Advance	$a_0$							Form
Number	$a_1$							All
	$a_2$							
	abExpR							INPUT
	abExpReg							
	abs(							
	absExpand(							EXE
	aCoef							
	acSeq							

### [Number] key set

This key set provides the same keys as those on the keypad. Use this key set when you want to use only the touch screen for input or in place of the keypad while using horizontal (landscape) display orientation.

Catalog	=	$x$	$y$	$z$	$\wedge$	
Advance	(	7	8	9	$\div$	
Number	)	4	5	6	$\times$	
	,	1	2	3	-	
	(-)	0	.	E	+	
	$\leftarrow$	$\leftarrow$	$\leftarrow$	$\leftarrow$	ans	EXE

## Input Basics

This section includes a number of examples that illustrate how to perform basic input procedures. All of the procedures assume the following.

- The Main application is running. See “Built-in Applications” (page 14).
- The soft keyboard is displayed. See “Using the Soft Keyboard” (page 18).

## ■ Inputting a Calculation Expression

You can input a calculation expression just as it is written, and press the **[EXE]** key to execute it. The ClassPad automatically determines the priority sequence of addition, subtraction, multiplication, division, and parenthetical expressions.

**Example:** To simplify  $-2 + 3 - 4 + 10$

### • Using the keypad keys



If the line where you want to input the calculation expression already contains input, be sure to press **[Clear]** to clear it.

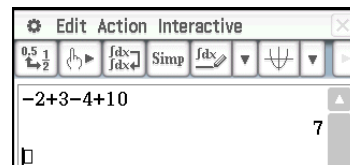

### • Using the soft keyboard

Tap the keys of the [Number] keyboard to input the calculation expression.

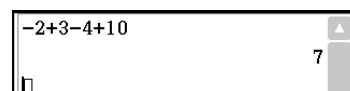

As shown in the above Example, you can input simple arithmetic calculations using either the keypad keys or the soft keyboard. Input using the soft keyboard is required to input higher level calculation expressions, functions, variables, etc. See Chapter 2 for more information about inputting expressions.

**Tip:** In some cases, the input expression and output expression (result) may not fit in the display area. If this happens, tap the left or right arrows that appear on the display to scroll the expression screen and view the part that does not fit.

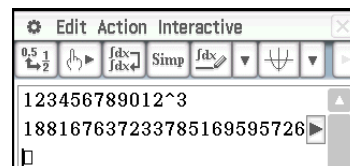

You can also change the display orientation to horizontal (landscape) for easier-to-read display of long input formulas and calculation results. See “Changing the Display Orientation” (page 16).

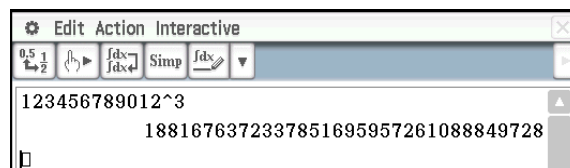

## ■ Editing Input

### • To delete a single character

Move the cursor so it is directly to the right of the character you want to delete, and then press **[←]**. Each press of **[←]** deletes one character to the left of the cursor.

**Example:** To change the expression  $369 \times \times 2$  to  $369 \times 2$

1. **[Clear] [3] [6] [9] [X] [X] [2]**

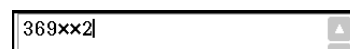

2. **[←] [←]**

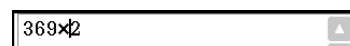

After you make all of the changes you want, press **[EXE]** to calculate the result. To add more characters to the calculation, press **[▶]** to move the cursor to the end of the calculation, and input what you want.

**Tip:** You can move the cursor without using the cursor key by tapping at the destination with the stylus. This causes the cursor to jump to the location where you tap.

### • To insert new input into the middle of an existing calculation expression

Use **[◀]** or **[▶]** to move the cursor to the location where you want to insert new input, and then input what you want.

**Example:** To change  $30^2$  to  $\sin(30)^2$  (For input, use the keypad and the [Math1] soft keyboard set.)

- 1.
- 2.
- 3.

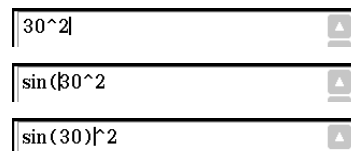

### • To replace a range of input with new input

After you drag the stylus across the range of input that you want to replace, enter the new input.

**Example:** To change “1234567” to “10567”

- 1.
2. Drag the stylus across “234” to select it.
- 3.

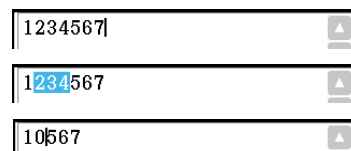

## ■ Using the Clipboard for Copy and Paste

You can copy (or cut) a function, command, or other input to the ClassPad’s clipboard, and then paste the clipboard contents at another location. Performing a copy or cut operation causes the current clipboard contents to be replaced by the newly copied or cut characters.

### • To copy characters

1. Drag the stylus across the characters you want to copy to select them.
2. On the soft keyboard, tap . Or tap the [Edit] menu and then tap [Copy].
  - This puts a copy of the selected characters onto the clipboard.

### • To cut characters

1. Drag the stylus across the characters you want to cut to select them.
2. Tap the [Edit] menu and then tap [Cut].
  - This causes the selected characters to be deleted, and moves them onto the clipboard.

### • To paste the clipboard contents

1. Move the cursor to the location where you want to paste the clipboard contents.
2. On the soft keyboard, tap . Or tap the [Edit] menu and then tap [Paste].
  - This pastes the clipboard contents at the current cursor location.

**Tip:** The clipboard contents remain on the clipboard after you paste them. This means you can paste the current contents as many times as you like.

### Copying and pasting in the message box

The “message box” is a 1-line input and display area under the Graph window (see Chapter 3).

You can use the two buttons to the right of the message box to copy the message box contents ( button), or to paste the clipboard contents to the message box ( button). Copy and paste are performed the same way as the copy and paste operations using the soft keyboard.

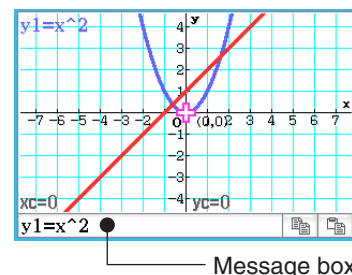

## ■ Copying with Drag and Drop

You can also copy a string of text by simply selecting it and then dragging it to another location that allows text input.

**Example 1:** To use the Main application to perform the calculation  $15 + 6 \times 2$ , edit to  $(15 + 6) \times 2$ , and then re-calculate

1. In the Main application work area, perform the calculation below.



2. Drag across the  $15 + 6 \times 2$  expression to select it, and then drag the expression to the  $\square$ .

- This will copy  $15 + 6 \times 2$  to the location where you dropped it.



3. Add parentheses before and after  $15 + 6$  and then press **EXE**.

**Tip:** You can use drag and drop to copy both input formulas and calculation results.

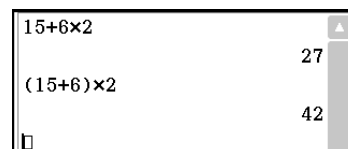

**Example 2:** To copy an expression you input with the Main application to the Graph Editor window

1. In the Main application work area, input:  $2x^2 + 2x - 1$ .

2. On the right end of the toolbar, tap the down arrow button. On the button palette that appears, tap  $\begin{matrix} Y1: \\ Y2: \end{matrix}$ .

- This will display the Graph Editor window in the bottom half of the screen.

3. Select the  $2x^2 + 2x - 1$  expression you input with the Main application by dragging across it, and then drag the expression to the  $\square$  located to the right of  $y1$ : on the Graph Editor window.

- This will copy  $2x^2 + 2x - 1$  to the location where you dropped it.

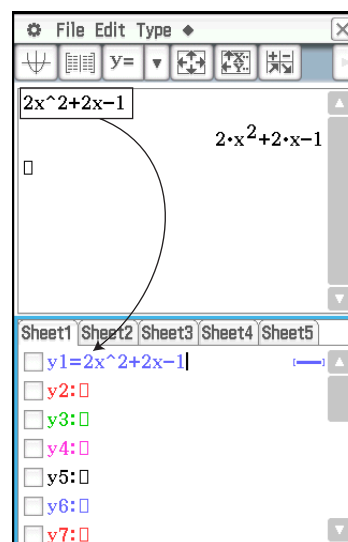

### Tip

- An expression you copy using the operation above is registered to the Graph Editor window of the Graph & Table application. For information about Graph Editor window operations, see Chapter 3.
- Depending on the destination to which you drag a character string or an expression, the drop operation may cause it to be converted automatically to a graph or a figure. For example, dropping the expression in Example 2 into the Graph window will graph the expression. Refer to the locations provided below to see examples using drag and drop.
  - “2-9 Using the Main Application in Combination with Other Applications” (Chapter 2, page 92)
  - “5-4 Graphing an Expression or Value by Dropping It into the Differential Equation Graph Window” (Chapter 5, page 128)
  - “8-5 Using the Geometry Application with Other Applications” (Chapter 8, page 177)
  - “13-1 Inputting and Editing Cell Contents” (Chapter 13, page 228), “13-2 Graphing” (Chapter 13, page 237)

## Various Soft Keyboard Operations





This section explains how to use each of the soft keyboard key sets. For information about key set types and a general overview of key sets, see “Soft Keyboard Key Sets” (page 18). All of the examples in this section assume the following conditions.

- The Main application is running. See “Built-in Applications” (page 14).
- The soft keyboard is displayed. See “Using the Soft Keyboard” (page 18).



## ■ Using Math, Trig, and Advance Key Sets



The [Math1], [Math2], [Math3], [Trig] (trigonometric), and [Advance] key sets contain keys for inputting numeric expressions.

The  key in the upper left corner and all of the keys in the bottom row are common to all key sets. Their functions are described below.

Math1	Line			$\pi$	$\Rightarrow$
Math2	$\square$	$e^{\square}$	ln	$\log_{\square}$	$\sqrt{\square}$
Math3	$\square$	$x^2$	$x^{-1}$	$\log_{10}(\square)$	solve(
Trig	$\square$	toDMS	{	}	( )
Var	sin	cos	tan	$^{\circ}$	r
abc	$\leftarrow$			ans	EXE

 Switches between template input and line input. See “Template Input and Line Input” (page 24).







 Performs the same operation as the keypad’s  key. Deletes the character to the left of the current cursor position.

  See “Using the Clipboard for Copy and Paste” (page 21).

 Inputs “ans”. See “Using the Answer Variable (ans)” (page 45).

 Performs the same operation as the keypad’s  key, which executes calculations.

The keys in the following table are found on different key sets and are used to input functions and commands for performing particular calculations and operations.

Key set	Key	Description
Math1, Math2, Math3, Trig	 	“Template Input and Line Input” (page 24), “Other Functions” (page 50)
	$\pi$	Inputs pi ( $\pi$ ).
	$\Rightarrow$	Inputs the substitution symbol ( $\Rightarrow$ ). “Creating a New Variable” (page 33)
Math1, Math2, Trig	$\square$	“Logarithmic Functions and Exponential Functions” (page 49)
	  	“Trigonometric and Inverse Trigonometric Functions” (page 49)
Math1, Math2	$e^{\square}$ 	“Logarithmic Functions and Exponential Functions” (page 49)
Math1, Math2	$\square$	Inputs the absolute value symbol (   ) or function (abs()).
Math1, Math3	solve(	“solve [Action][Equation/Inequality][solve]” (page 81)
Math1, Math3	( )	Inputs parentheses (( )).
Math1, Math3	{ }	Inputs brackets ({ }). “2-4 List Calculations” (page 57)
Math1, Trig	$^{\circ}$ 	“Angle Conversion ( $^{\circ}$ , r)” (page 48)
Math1	$\log_{\square}$ $\log_{10}(\square)$ $\sqrt{\square}$	“Logarithmic Functions and Exponential Functions” (page 49)
Math1	$x^2$ $x^{-1}$	“Other Functions” (page 50)
Math1	$\square$	“dms [Action][Transformation][DMS][dms]” (page 64)
Math1	toDMS	“toDMS [Action][Transformation][DMS][toDMS]” (page 64)
Math1	{	“solve [Action][Equation/Inequality][solve]” (page 81)
Math2, Math3, Trig	$i$	Inputs the imaginary unit ( $i$ ).
	$\infty$	Inputs the infinity symbol ( $\infty$ ).
Math2, Trig	$\theta$	Inputs the $\theta$ variable.
Math2, Trig	$t$	Inputs the single-character variable (page 25) $t$ .

Key set	Key	Description
Math2		“Using the Calculation Submenu” (page 67)
Math2		“2-5 Matrix and Vector Calculations” (page 58)
Math3		“To create a user-defined function using the Define command” (page 203)
Math3		Inputs the “f” of f(x), or the “g” of g(x).
Math3		“Derivative Symbol (’)” (page 54)
Math3		“dSolve [Action][Equation/Inequality][dSolve]” (page 82)
Math3		“piecewise Function” (page 54)
Math3		“with Operator (   )” (page 55)
Math3		Inputs square brackets ( [ ] ). “2-5 Matrix and Vector Calculations” (page 58)
Math3		“Equal Symbols and Unequal Symbols” (page 55)
Math3		“Angle Symbol (∠)” (page 54)
Trig		“Trigonometric and Inverse Trigonometric Functions” (page 49)
Trig		“Hyperbolic and Inverse Hyperbolic Functions” (page 49)
Advance		“Other Functions” (page 50)
Advance		“Permutation ( $nPr$ ) and Combination ( $nCr$ )” (page 53)
Advance		“Chapter 6: Sequence Application”
Advance		“About rSolve” (page 131)
Advance		“Using the Advanced Submenu” (page 64)
Advance		“Gamma Function” (page 57)
Advance		“Dirac Delta Function” (page 56)
Advance		“ $n$ th-Delta Function” (page 56)
Advance		“Heaviside Unit Step Function” (page 56)

## ■ Template Input and Line Input

ClassPad supports two different input methods: template input and line input. Template input lets you input fractions, powers, and other functions using formats that are the same as those in textbooks. Line input uses a linear format for inputting expressions.

$$2 + \left( \frac{2\sqrt{2}}{\sqrt{2} + 1} \right)^2$$

Template Input

$$2 + (2\sqrt{2}) / (\sqrt{2} + 1)^2$$

Line Input





### • To input a single-character variable name

Any character you input using any one of the following techniques is always treated as a single-character variable.

- Tapping any key in the [Var] (variable) key set (page 19)
- Tapping the  $x$ ,  $y$ , or  $z$  key of the [Number] key set
- Tapping the  $x$  key of the [Math2] key set
- Pressing the  $x$ ,  $y$ , or  $z$  keypad key

If you use the above key operations to input a series of characters, each one is treated as a single-character variable. Inputting  $a$ ,  $b$ ,  $c$  using the [Var] key set, for example, is treated as the mathematical expression  $a \times b \times c$ , and not as the characters “abc”.

**Tip:** The single-character variables described above make it possible for you to perform calculations as they appear in your textbook.

**Example 1:**  $a$   $b$   $c$  [EXE]

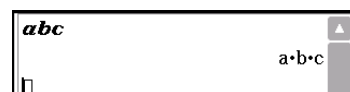

**Example 2:**  $2$   $x$   $y$  [EXE]



**Tip:** When you input a single-character variable, its name appears on the display as an italicized character. This is simply to let you know that the letter is a single-character variable name.

### • To input a series of multiple characters

A series of multiple characters (like “list1”) can be used for variable names, program commands, comment text, etc. Always use the [abc] key set when you want to input a series of characters.

**Example:**  $a$   $b$   $c$  [EXE]

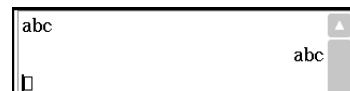

You can also use the [abc] key set to input single-character variable names. To do so, simply input a single character, or follow a single character with a mathematical operator.

**Example:**  $a$   $x$   $b$   $+$   $c$  [EXE]



**Tip:** A single-character variable you input using the [abc] key set is identical to a single-character variable you input using the [Var] key set.

### ■ Using the Alphabet Keyboard

Tap the [abc] tab to the left of the soft keyboard to display the alphabet keyboard [abc] key set. In addition to the [abc] key set, you can also select from among three other key sets named  $\alpha\beta\gamma$  (character symbols), [Math] (mathematics symbols), and [Symbol] (extra symbols).

Use the tabs above the alphabet keyboard (to the right of the keyboard when using horizontal screen orientation) to select a key set. To return to the [Math1] key set from the alphabet keyboard, tap the  $\leftarrow$  key in the lower left corner.

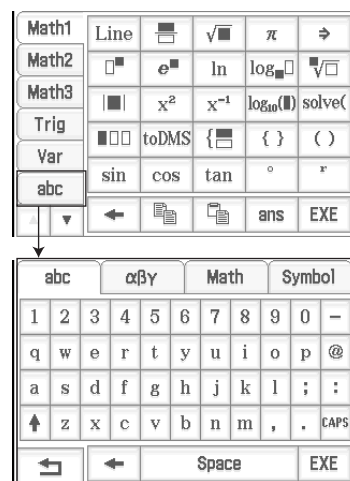

## ■ Using the Catalog Keyboard

The “Form” menu of the catalog keyboard lets you select one of the five categories described below.

- Func** ..... built-in functions (pages 48 and 61)
- Cmd** ..... built-in commands and operators (page 206)
- Sys** ..... system variables (page 299)
- User** ..... user-defined functions (page 203)
- All** ..... all commands, functions, etc.

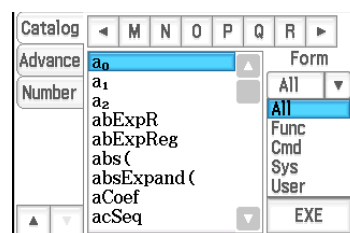

After selecting a category, you can choose the item you want from the alphabetized list that appears on the catalog keyboard.

**Tip:** Note that user-defined variables and user-defined programs cannot be input using the catalog keyboard. Use Variable Manager (page 29) instead.

### Catalog keyboard configuration

Tapping a letter button displays the commands, functions, or other items that begin with that letter.

This is an alphabetized list of commands, functions, and other items available in the category currently selected with “Form”.

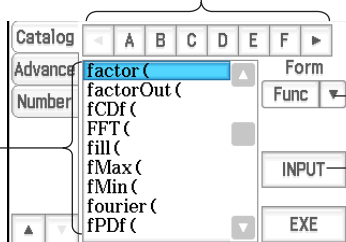

Tap the down arrow button and then select the category you want ([Func], [Cmd], [Sys], [User], or [All]) from the list that appears.

Tap this key to input the item that is currently selected in the alphabetized list.

### • To use the catalog keyboard

**Example:** To input the built-in command “Plot”

1. On the catalog keyboard, tap the “Form” down arrow button and then select [Cmd] from the list of categories that appears.
2. Tap the button in the upper right corner until the button is visible.
3. Tap .
4. In the alphabetized list, tap “Plot” and then tap [INPUT] to input the command.
  - Instead of tapping [INPUT], you could also tap the command a second time to input the command.

## 1-5 ClassPad Data

This section provides information about the various types of data that can be stored in ClassPad memory, and the location where each type of data is stored. It also explains how to use Variable Manager, which is a tool for managing stored data, as well as file operations (file save, recall, delete, rename, etc.) that are common to a number of different applications.

### Data Types and Storage Locations (Memory Areas)

ClassPad uses a “main memory” memory area to store various types of data.

#### Examples:

- Executing “10⇒x” (which assigns a value of 10 to variable  $x$ ) in the Main application or eActivity application causes variable  $x$  to be stored in main memory as “EXPR” (expression) type data.
- Creating a user-defined function (page 203) causes the function to be stored in main memory as “FUNC” (function) type data.

- Saving a spreadsheet to a file (by executing [File] - [Save] with the Spreadsheet application) saves the file in main memory as “MEM” (memory) type data.

An eActivity file created with the eActivity is stored in a separate eActivity memory area in order to keep it separate from other application data.

### Accessing Data

Besides the application that originally created it, data in main memory can also be accessed by any other application. It can also be deleted, renamed, copied, moved and otherwise accessed using Variable Manager (page 29). eActivity files can be accessed from the eActivity application only.

---

## Main Memory Data Types

Data stored in main memory has a *data type* attribute that is assigned in accordance with the application that created the data and the actual content of the data. The data type is indicated by a *data type name*. Data type names are shown on the Variable Manager variable list, and on the Select Data dialog box that appears when you are specifying a variable in any ClassPad application. The following table lists all of the data type names and explains the meaning of each.

Data Type Name	Data Type
EXPR	Real number, complex number or expression data
STR	String data
LIST	List data created using the Statistics application, Main application, etc.
MAT	Matrix data created using the Main application, etc.
PRGM*	General program
EXE*	Edit prohibited program
TEXT*	Text data
FUNC*	User-defined function
GMEM*	Graph memory data saved using the Graph & Table application For more information, see “Saving Graph Editor Data to Graph Memory” (page 102).
GEO*	Geometry application data
MEM*	Data saved to a file using one of the following applications: Spreadsheet, Geometry, Verify (page 94), Probability (page 95).
OTHR	Data other than that described above

### Protected variable types

Some data types are protected. A variable whose data type is protected cannot be overwritten with another variable, which protects variable contents from being inadvertently altered. Data types whose names are marked with an asterisk in the above table are protected. Note that whether or not a data type is protected is determined by the system. You cannot change the protection status of a data type.

**Tip:** Even when a variable is a protected data type, you can rename, delete, or move it. To disable these operations, you need to lock the variable. See “Variable Manager operations” on page 30.

---

## Main Memory Folders

Your ClassPad stores data in one of the following types of folders described below.

**“main” folder:** The “main” folder is a ClassPad reserved folder, and acts as the default current folder (see “Current Folder” below).

**“library” folder:** Also a ClassPad reserved folder, the “library” folder can be used for storing user-created data (variables, programs, user functions, etc.). Data stored in the “library” folder can be accessed without specifying a path, regardless of the current folder setting.

**User folder:** This is a folder created and named by you. You can make a user folder the current folder, move data to a user folder, etc. You can also delete and rename a user folder as required. You can have up to 87 user folders in main memory at one time.

**Tip:** You cannot put a folder inside of another folder.

### Current Folder

The *current folder* is the folder where the data (excluding eActivity files) created by applications are stored and from which such data can be accessed. The initial default current folder is the “main” folder. You can also select a user folder you created as the current folder. For more information about how to do this, see “Variable Manager operations” on page 30.

## Using Variable Manager

Variable Manager is a tool for managing user variables, programs, user functions, and other types of data. Though this section uses only the term “variables”, the explanations provided here also refer to the other types of data that can be managed by Variable Manager.

With Variable Manager you can:

- Create, delete, rename, lock, and unlock folders, and configure current folder settings.
- Delete, copy, rename, move, lock, unlock, search for variables, and view the contents of variables.

### About Variable Types

A variable with a letter name like  $x$  and  $y$  can be a user-created user variable, a system variable, or a local variable.

- System variables are pre-defined reserved variables, and cannot be renamed. For the names of and detailed information about system variables, see the “System Variable Table” on page 299.
- A local variable is a variable that is temporarily created by a defining function, program, or other operation for a particular purpose. For more information about local variables, see the “Local” command under the “12-4 Program Command Reference”.

### • To start up Variable Manager

1. While any application (except for the System application) is running, tap  and then tap [Variable Manager].

- This displays the folder list. The folder list always appears first whenever you start up Variable Manager.

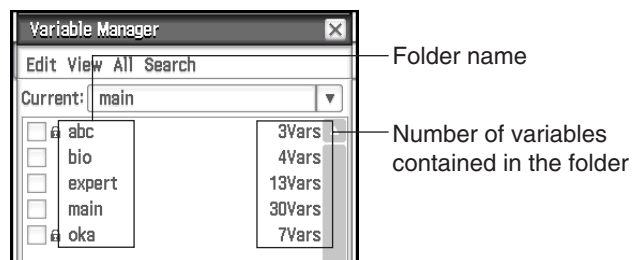

**Folder list**

2. Tap a folder name twice to open the folder contents; a variable list.

- To close the variable list and return to the folder list, tap [Close].

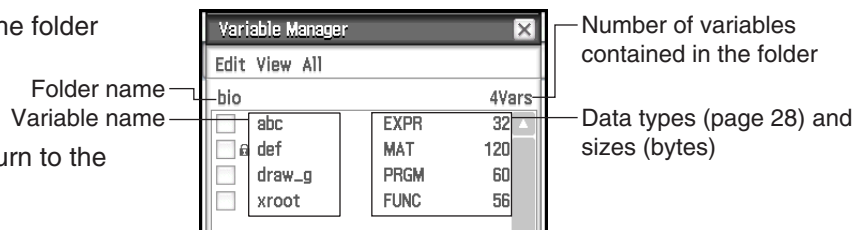

**Variable list**

3. To exit Variable Manager, tap [Close] on the folder list.

## • Variable Manager operations

The operations described in the table below can be performed while Variable Manager is displayed.

To do this:	Do this:
Specify the current folder	On the folder list, tap the [Current] down arrow button. On the list that appears, select the folder that you want to specify as the current folder.
Create a folder	On the folder list, tap [Edit] - [Create Folder]. On the dialog box that appears, enter the name you want to assign to the folder and then tap [OK].
Open a folder	On the folder list, tap the name of the folder you want to open so it is highlighted, and then tap it again.
Open the “library” folder	Tap [View] and then [“library” Folder]. This opens the “library” folder and displays a variable list showing its contents.
Select a folder or variable	Select the check box next to the folder or variable name. To select all the folders or variables in the list, tap [All] and then [Select All].
Deselect a folder or variable	Clear the check box next to the folder or variable name. To deselect all the folders or variables in the list, tap [All] and then [Deselect All].
Delete a folder	See “To delete a folder” (page 31).
Delete a variable	Select the check box next to the variable you want to delete, and then tap [Edit] - [Delete]. In response to the confirmation dialog box that appears, tap [OK] to delete the selected variable.
Rename a folder or variable	Highlight the folder or variable you want to rename and then tap [File] - [Rename]. On the dialog box that appears, enter the name you want to assign to it and then tap [OK].
Lock a folder or variable	Select the check box next to the folder or variable you want to lock, and then tap [Edit] - [Lock]. This locks the currently selected folder or variable, and adds a  icon to the left of its name to indicate that it is locked.
Unlock a folder or variable	Select the check box next to the folder or variable you want to unlock, and then tap [Edit] - [Unlock].
Display a list of a particular type of variable	On the variable list, tap [View] - [Variable Type]. On the dialog box that appears, tap the down arrow button and then select the data type from the list that appears and then tap [OK].
Copy or move a variable	On the variable list, tap [Edit] and then [Copy] or [Move]. On the dialog box that appears, tap the down arrow button and then select the destination folder from the list that appears and then tap [OK]. <b>Tip</b> <ul style="list-style-type: none"> <li>• If a variable with the same name already exists in the destination folder, the variable in the destination folder is replaced with the one that you are copying or moving.</li> <li>• A variable that is locked cannot be moved.</li> </ul>
View the contents of a variable	On the variable list, tap the name of the variable whose contents you want to view so it is highlighted, and then tap it again. This displays a dialog box that shows the contents of the variable.
Input a folder name or variable name into an application	See “To input a folder name or variable name into an application” (page 31).
Search for a variable	On the folder list, tap [Search]. On the dialog box that appears, enter the variable name you want to find and then tap [OK]. An exclamation point (!) appears in front of all folders containing a variable name that matches the name in your search. <b>Note:</b> You can use the above procedure to search the “main” folder or a user defined folder for a particular variable name. Note that you cannot search the “library” folder.

### **Selecting a Folder**

- If no check box is selected on the folder list, any folder operation that is performed affects the folder whose name is currently highlighted on the list. If any folder check box is selected, only that folder is affected by a folder operation, and the folder whose name is highlighted on the list is not affected.
- Selecting the check box of a folder causes the check boxes of all of the variables inside of it also to become selected.
- When renaming a folder, only the folder whose name is highlighted on the folder list is renamed. Other folders whose check boxes are selected are not affected.

### **Selecting a Variable**

- If no check box is selected on the variable list, any variable operation that is performed affects the variable whose name is currently highlighted on the list. If any variable check box is selected, only that variable is affected by a variable operation, and the variable whose name is highlighted on the list is not affected.
- When renaming a variable, only the variable whose name is highlighted on the variable list is renamed. If other variables are selected (checked), they will not be affected.

### **Folder and Variable Name Rules**

The following are the rules that apply to folder and variable names.

- Folder or variable names can be up to 8 bytes long.
- The following characters are allowed in a folder or variable name: Upper-case and lower-case characters, subscript characters, numbers, underscore (\_).
- Folder or variable names are case-sensitive. For example, each of the following is treated as a different folder/variable name: abc, Abc, aBc, ABC.
- A reserved word (system variable names, built-in function names, command names, etc.) cannot be used as a folder or variable name.
- A number, subscript characters or the underscore (\_) cannot be used as the first character of a folder or variable name.

#### **• To delete a folder**

##### **Important!**

Before deleting a folder, make sure you no longer need any of the variables contained inside it. It is probably a good idea to first delete the variables you don't need, move the variables you do need to another folder, and then delete the empty folder.

1. Open the folder you want to delete and check its contents.
  - Make sure you no longer need any of the variables in the folder. If any of the variables are locked, unlock them.
  - After checking the contents of the folder, close it to return to the folder list.
2. Select the check box next to the folder you want to delete.
  - You can select and delete multiple folders, if you want.
3. On the folder list, tap [Edit] and then [Delete].
4. In response to the confirmation dialog box that appears, tap [OK] to delete the folder.

**Tip:** You cannot delete the “library” folder or the “main” folder.

#### **• To input a folder name or variable name into an application**

1. In the Main application, Graph & Table application, or some other application, move the cursor to the location where you want to input the variable name.
2. Start up Variable Manager to display the folder list.
3. If you want to input a variable name, double-tap the folder that includes the variable whose name you want to input. If you want to input a folder name, advance to the next step.

4. Tap the folder or variable whose name you want to input, so its name is highlighted.
5. Tap [INPUT].
  - This exits Variable Manager and inputs the name of the folder or variable you selected in step 4 into the application at the current cursor position.

---

## Managing Application Files

The applications below can save data to files.

Geometry (Chapter 8), eActivity (Chapter 10), Spreadsheet (Chapter 13), Verify (page 94), Probability (page 95), Picture Plot (Chapter 15)

This section explains the common operations that can be performed on data files created with these applications.

**Tip:** The eActivity file save dialog box is slightly different from the save dialog box of the other applications, but operations are basically the same.

### • To save a file

1. Tap [File] and then [Save].
2. On the dialog box that appears, tap the name of the folder where you want to save the file so it is selected.
3. Input up to 8 bytes for the file name in the file name edit box, and then tap [Save].

### • To open an existing file

1. Tap [File] and then [Open].
2. On the dialog box that appears, open the folder that contains the file you want to open.
3. Tap the name of the file you want to open so it is selected, and then tap [Open].

### • To search for a file

1. Tap [File] and then [Open].
2. On the dialog box that appears, tap [Search]. This displays the Search dialog box.
3. Enter the file name you want to find and then tap [Search].
  - File names that match the one you enter become highlighted on the display. Tapping [Open] opens the highlighted file.
  - To search for the next occurrence of the file name, tap [Search] again and then tap [Next] on the Search dialog box.

### • To delete a folder or file

#### **Important!**

Deleting a folder also deletes all files inside of it. Please double-check to make sure you no longer need the contents of a folder before deleting it.

1. Tap [File] and then [Open].
2. On the dialog box that appears, select the check box next to the folder or file you want to delete.
  - You can select multiple folders/files for deletion, if you want.
  - Selecting a check box next to a folder name automatically checks the boxes for all files inside that folder.
3. Tap [File] and then [Delete].
4. In response to the confirmation dialog box that appears, tap [OK] to delete the folder(s) or file(s).

**Tip:** Selecting a folder in the above procedure deletes the folder and all of its contents. Note, however, that the “main” folder cannot be deleted, even if you check it.



### • To rename a folder or file

1. Tap [File] and then [Open].
2. On the dialog box that appears, tap the name of the folder or file you want to rename so it is selected.
3. Tap [File] and then [Rename]. This displays the Rename dialog box.
4. Enter the name you want to assign to it and then tap [OK].

### • To move a file to another folder

1. Tap [File] and then [Open].
2. On the dialog box that appears, select the check box next to the file you want to move.
  - To move multiple files, select all of their check boxes.
3. Tap [File] and then [Move].
  - This causes a dialog box for selecting the destination folder to appear.
4. On the dialog box, tap the down arrow button and then select the destination folder from the list that appears.
5. Tap [OK] to move the files.

### • To switch the file menu view between List View and Detail View (eActivity application only)

1. Tap [File] and then [Open].
2. On the dialog box that appears, open the folder that contains the files you want to list.
3. To display both the file name and file size, tap [View] - [Detail View]. To display file names only, tap [View] - [List View].

### • To create a new folder

1. Tap [File] and then [Open].
2. On the dialog box that appears, tap [File] and then [Create Folder], or tap .
  - This displays the Create Folder dialog box.
3. Enter up to 8 bytes for the folder name, and then tap [OK] to create a folder.

## 1-6 Creating and Using Variables

This section explains how to create a new variable (user variable), and provides a simple sample calculation that illustrates how to use a variable.

---

### Creating a New Variable









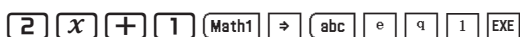

The most common way to create a new variable is assigning a value or expression to the applicable variable name. Use the variable assignment key () to assign data to a variable.

The following is an example of assignment to a variable while “main” is specified as the current folder.

**Example:** To create a new variable named “eq1” and assign the expression  $2x + 1$  to it  
The following assumes that there are no variables named “eq1” or “x” currently in the “main” folder.

### • ClassPad Operation

1. Start the Main application.
2. Press  to display the soft keyboard, and then perform the following key operation.

- This creates a variable named “eq1” in the current folder (the “main” folder in this example), and assigns the expression  $2x + 1$  to it.

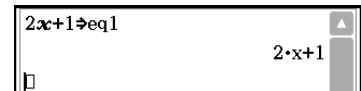

### Tip

- If a variable with the specified name already exists in the current folder, the contents of the existing variable are replaced with the newly assigned data, unless the existing variable is locked or protected. For more information, see “Variable Manager operations” (page 30) and “Protected variable types” (page 28).
- To store the newly created variable in a folder other than the current folder, specify the variable name as follows: <folder name>\<variable name>.
- You can use Variable Manager to view the contents of a variable you create. For more information, see “Variable Manager operations” (page 30).
- For information about rules for naming variables, see “Folder and Variable Name Rules” (page 31).

## Variable Usage Example

The following example uses the variable we created in the example under “Creating a New Variable” above.

**Example:** To assign values of 5 and 10 to  $x$  and check the results of eq1 ( $= 2x + 1$ )

### • ClassPad Operation

1. Assign 5 to  $x$ .

$5$   $\rightarrow$   $x$   $\rightarrow$   $\text{EXE}$

2. Check the contents of variable “eq1”.

$\text{abc}$   $\rightarrow$   $e$   $\rightarrow$   $q$   $\rightarrow$   $1$   $\rightarrow$   $\text{EXE}$

- This displays the calculation result of  $2x + 1$  when  $x = 5$ .

3. Assign 10 to  $x$ .

$10$   $\rightarrow$   $x$   $\rightarrow$   $\text{EXE}$

4. Check the contents of variable “eq1”.

$\text{abc}$   $\rightarrow$   $e$   $\rightarrow$   $q$   $\rightarrow$   $1$   $\rightarrow$   $\text{EXE}$

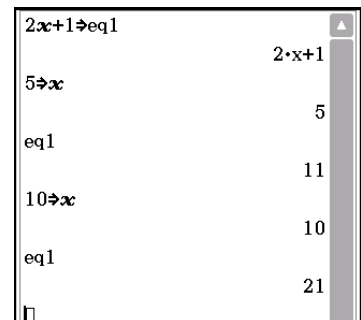

## “library” Folder Variables

Variables in the “library” folder can be accessed without specifying a path name, regardless of the current folder.

**Example:** To create and access two variables, one located in the “library” folder and one located in another folder

### • ClassPad Operation

1. With “main” specified as the current folder, perform the following operation to create a variable named “eq1” and assign the indicated list data to it.

$\{1, 2, 3\}$   $\rightarrow$  eq1  $\rightarrow$   $\text{EXE}$

2. Keeping “main” specified as the current folder, perform the following operation to create a variable named “eq2” in the “library” folder, and assign the indicated list data to it.

$\{4, 5, 6\}$   $\rightarrow$  library\eq2  $\rightarrow$   $\text{EXE}$

3. Check the contents of the two variables.

eq1  $\rightarrow$   $\text{EXE}$

eq2  $\rightarrow$   $\text{EXE}$

(Since variable “eq2” is stored in the “library” folder, you do not need to indicate a path to access it.)

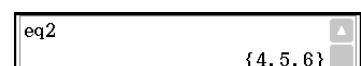

4. Change the current folder specification to “Test”.

- Use Variable Manager (page 29) to create a folder named “Test” and change the current folder specification.

5. Perform the following operations to view the contents of variables “eq1” and “eq2”.

eq1 [EXE]

(Since this key operation does not access the “main” folder, the variable name (“eq1”) is displayed without showing the variable contents.)

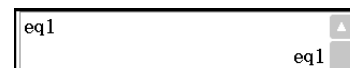

main\eq1 [EXE]

(Specifying the path to the “main” folder where “eq1” is located displays the contents of the variable.)



eq2 [EXE]

(Since variable “eq2” is stored in the “library” folder, you do not need to indicate a path to access it.)

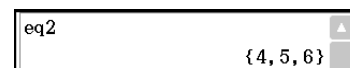

**Tip:** Specifying a variable name that exists in both the current folder and the “library” folder causes the variable in the current folder to be accessed. For details about the variable access priority sequence and how to access variables in particular folders, see “Rules Governing Variable Access” below.

---

## Rules Governing Variable Access

Normally, you access a variable by specifying its variable name. The rules in this section apply when you need to reference a variable that is not located in the current folder or to access a variable that has the same name as one or more variables located in other folders.

### ■ Variable Search Priority Sequence

Specifying a variable name to access a variable causes variables to be searched in the sequence below.

(1) Local variables	(2) Current folder variables	(3) “library” folder variables
---------------------	------------------------------	--------------------------------

- Multiple variables with the same name can exist simultaneously as a local variable, as a variable in the current folder, and as a variable in the “library” folder. In this case, the ClassPad searches folders according to the sequence shown above and accesses the first instance of the variable that it finds. If you want to access such a variable when it occurs lower in the above sequence, you need to specify the folder name along with the variable name as shown in “Specifying a Variable in a Particular Folder” below.
- If a variable you specify cannot be found, it is treated as an “undefined variable”.
- Note that “system” variables are not included in the above variable search. When accessing a system variable, you need to specify the variable name only, without specifying the folder name.

**Tip:** Only local variables and current folder variables are searched in the case of an operation that stores variable data or a command that performs an operation on a variable (like “DelVar”). Normally, “library” folder variables are not searched. If you want to include “library” folders in the search, you need to specify the “library” folder as the variable location as explained below.

### ■ Specifying a Variable in a Particular Folder



You can access a variable located inside the “main” folder, “library” folder, or a particular user folder by specifying the folder name along with the variable name.

Use the following syntax when specifying a folder name:

<folder name>\<variable name>



**Example:** To specify variable “abc” located in the “main” folder  
main\abc

## 1-7 Configuring Application Format Settings

The  menu includes format settings for configuring the number of calculation result display digits and the angle unit, as well as application-specific commands. The following describes each of the settings and commands that are available on the  menu.

To do this:	Select this  menu command:
Specify folder for variables, and to configure number format, angle, and other basic settings for all built-in applications	Basic Format
Configure Graph window and graph drawing settings for Graph & Table, Conics, and other graphing applications	Graph Format
Configure number format, angle, and other settings for Geometry application	Geometry Format
Configure Fourier transform and FFT settings	Advanced Format
Configure Financial application settings	Financial Format
Return all the above menu settings to their initial default values (except for the current folder setting specified on Basic Format dialog box)	Default Setup

### • To configure application format settings

1. Open any application (except the System application).
2. Tap . Next, tap the menu command you want: Basic Format, Graph Format, Geometry Format, Advanced Format, or Financial Format.
3. Use the dialog box to configure the settings you want.
  - For details about the settings you can configure on each of the dialog boxes, see “Application Format Settings” below.
4. To close a dialog box and apply its settings, tap [Set]. To close a dialog box without applying its settings, tap [Cancel] or the  button in the upper right corner of the dialog box.

## Application Format Settings

This section provides details about all of the settings you can configure using the application format settings. Settings marked with an asterisk (\*) in the following explanations are ClassPad initial default settings.

### ■ Basic Format Dialog Box

Use the Basic Format dialog box to configure basic settings for calculations, cells, and other parameters.

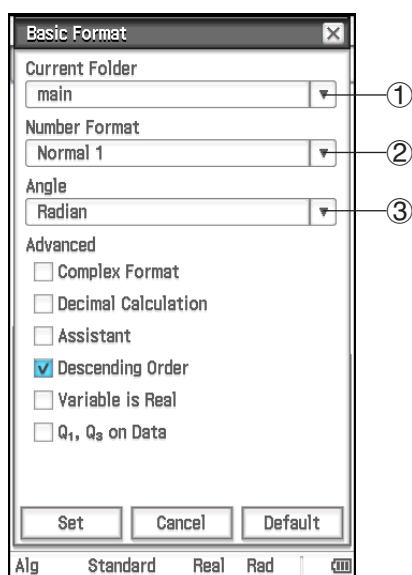

#### To specify the current folder

Tap ① and then tap the name of the folder (main\*) you want.

#### To specify the numeric value display format

Tap ② and then tap one of the settings described below.

Normal 1\*: Automatically uses exponential display format when calculation result  $x$  is:  $10^{-2} > |x|$  or  $|x| \geq 10^{10}$ .

Normal 2: Automatically uses exponential display format when calculation result  $x$  is:  $10^{-9} > |x|$  or  $|x| \geq 10^{10}$ .

Fix 0 – Fix 9: Fixed number of decimal places

Sci 0 – Sci 9: Fixed number of significant digits

#### To specify the angle unit

Tap ③, and then tap “Radian\*”, “Degree”, or “Grad”.

To do this:	Do this:
Switch between complex number calculations (Complex mode) and real number calculations (Real mode)	Select the “Complex Format” check box to enter the Complex mode, or clear the check box* to enter the Real mode*.
Display results as a decimal value (Decimal mode) or leave calculation results as expressions (Standard mode)	Select the “Decimal Calculation” check box to enter the Decimal mode, or clear the check box* to enter the Standard mode.
Turn auto simplification of expressions on (Algebra mode) or off (Assistant mode)	Select the “Assistant” check box to enter the Assistant mode, or clear the check box* to enter the Algebra mode. See page 47 for details.
Specify descending order or ascending order for the calculation result expression	Select the “Descending Order” check box* to display calculation result expressions in descending order (like $x^2 + x + 1$ ), or clear the check box to display in ascending order (like $1 + x + x^2$ ).
Specify whether variables in Complex Mode calculation should be treated as real numbers or complex numbers	Select the “Variable is Real” check box to treat variables as real numbers, or clear the check box* to treat variables as complex numbers.

**Tip:** For information about the “Q<sub>1</sub>, Q<sub>3</sub> on Data” check box, see “Calculation Methods for Q<sub>1</sub>, Q<sub>3</sub> and Median” (page 141).

### Using Status Bar to Change Application Format Settings

With the applications listed in the table below, you can use the status bar to check and modify a number of Basic Format dialog box settings.

For this application:	You can check and change these settings:
Main, eActivity	Algebra mode/Assistant mode setting, Standard mode/Decimal mode setting, Complex mode/Real mode setting, angle unit setting
Statistics	Standard mode/Decimal mode setting, angle unit setting
Graph & Table, Conics, Differential Equation Graph, Numeric Solver, Sequence	Complex mode/Real mode setting, angle unit setting

#### • To use the status bar to change application format settings

On the status bar, tap the text of the setting you want to change.



Main application



Graph & Table application

Each tap changes the tapped item as described below.

- “Alg” ↔ “Assist” ... Toggles between the Algebra mode and Assistant mode.
- “Standard” ↔ “Decimal” ... Toggles between the Standard mode and Decimal mode.
- “Real” ↔ “Cplx” ... Toggles between the Real mode and Complex mode.
- “Rad” → “Deg” → “Gra” ... Cycles the angle unit setting between Radian, Degree, and Grad.

**Tip:** Changing a setting using the status bar has the same effect as changing the corresponding setting on the Basic Format dialog box. This means the setting will be changed for all applications.

## ■ Graph Format Dialog Box

Use the Graph Format dialog box to configure settings for the Graph window and for drawing graphs.

### [Basic] tab

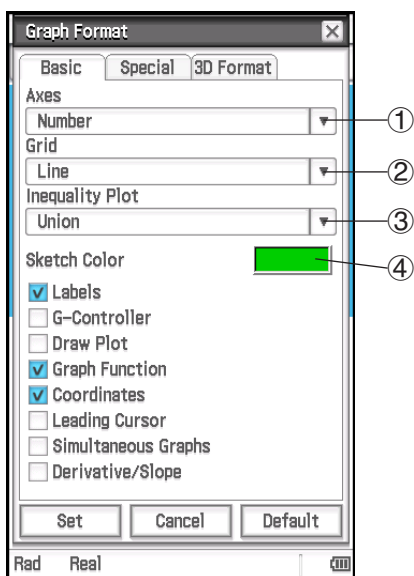

#### To specify display of Graph window axes

Tap ① and then tap one of the settings described below.

On: show axis

Off: hide axis

Number\*: show axis along with maximum and minimum value of each axis

#### To specify display of Graph window grid

Tap ② and then tap one of the settings described below.

On: show grid as dots

Off: hide grid

Line\*: show grid as lines

#### To select inequality fill specification (Inequality Plot)

Tap ③ and then tap one of the settings described below.

Union\*: fill areas where all inequality conditions are satisfied when graphing multiple inequalities

Intersection: fill areas where each inequality condition is satisfied when graphing multiple inequalities

#### To specify the color of figures and graphs drawn with the Sketch function (page 112)

Tap ④. On the dialog box that appears, select the color you want and then tap [OK].

To do this:	Do this:
Turn display of Graph window axis labels on or off	Select the “Labels” check box* to show labels, or clear the check box to hide labels. <b>Tip:</b> Regardless of the “Labels” setting, labels are never displayed on the Sequence application Graph window. Also, labels are not displayed for the following types of graph drawn with the Statistics application: NPPlot, Histogram, MedBox, NDist Broken.
Turn display of graph controller arrows on or off	Select the “G-Controller” check box to show graph controller arrows (page 105), or clear the check box* to hide graph controller arrows.
Specify plotted points or solid lines for graph drawing	Select the “Draw Plot” check box to specify plotted points, or clear the check box* to specify solid lines for graphing.
Turn display of the function name and function on or off	Select the “Graph Function” check box* to show the function name and function on the graph, or clear the check box to hide the function name and function.
Turn display of Graph window pointer coordinates on or off	Select the “Coordinates” check box* to show Graph window pointer coordinates, or clear the check box to hide the coordinates.
Turn display of the leading cursor during graphing on or off	Select the “Leading Cursor” check box to show the leading cursor, or clear the check box* to hide the leading cursor.
Specify the draw method when drawing multiple graphs	Select the “Simultaneous Graphs” check box to draw multiple graphs simultaneously, or clear the check box* to draw graphs in sequence, one at a time.
Show or hide derivative values on the Graph window and Table window	Select the “Derivative/Slope” check box to show derivative values in the Graph window and Table window, or clear the check box* to hide derivative values. For details about display contents, see “Using Trace to Read Graph Coordinates” (page 111) and “Generating a Number Table” (page 108).

## [Special] tab

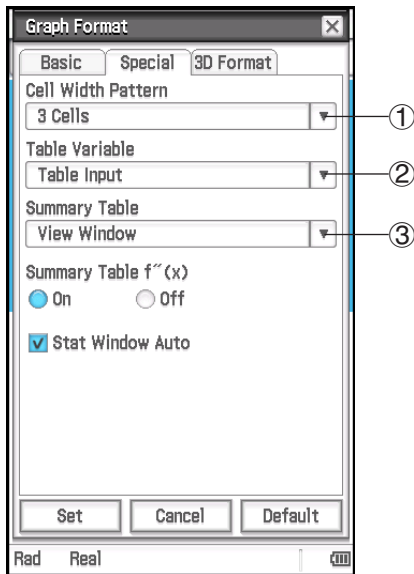

### To specify the row width for Stat Editor and data table displays

Tap ① and then select a cell width pattern: 2 Cells, 3 Cells\*, or 4 Cells for vertical display orientation, or 4 Cells, 5 Cells\*, or 6 Cells for horizontal orientation (see “Changing the Display Orientation” on page 16).

### To specify a source for table data

Tap ② and then tap one of the settings described below.

Table Input\*: Uses the data input in a Table Input dialog box as the source for number table generation.

list1 through list6: Uses list data in list1 through list6 as the source for number table generation.

<list name>: Uses the list data in a selected list as the source for number table generation.

For details about how to generate a number table using each setting, see “Generating a Number Table” (page 108).

### To specify a source for summary table data

Tap ③ and then tap one of the settings described below.

View Window\*: Uses View Window settings as the source for summary table generation.

list1 through list6: Uses list data in list1 through list6 as the source for summary table generation.

<list name>: Uses the list data in a selected list as the source for summary table generation.

For details about how to generate a summary table using each setting, see “Generating a Summary Table” (page 110).

### To show or hide the second derivative for summary tables

Select the On button\* under “Summary Table  $f''(x)$ ” to show the second derivative, or the Off button to hide it.

### To specify auto setting or manual setting of Statistics application View Window settings

Select the “Stat Window Auto” check box\* to specify automatic setting configuration, or clear the check box for manual settings.

## [3D Format] tab

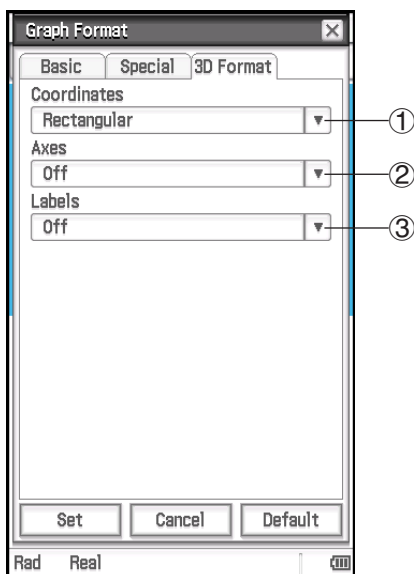

### To specify display of coordinate values

Tap ①, and then select “Rectangular\*” (display rectangular coordinate values), “Polar” (display polar coordinate values), or “Off” (turn off display of coordinates).

### To specify display of axes

Tap ② and then select “On” (display axes normally), “Box” (display box type coordinate axes), or “Off\*” (turn off display of axes).

### To turn display of Graph window axis labels on or off

Tap ③ and then select “On” or “Off\*”.

## ■ Geometry Format Dialog Box

Use the Geometry Format dialog box to configure settings for the Geometry application.

**Tip:** The information that appears in the preview area at the bottom of the dialog box shows a preview of the Geometry application window, based on the settings configured in upper part of the dialog box.

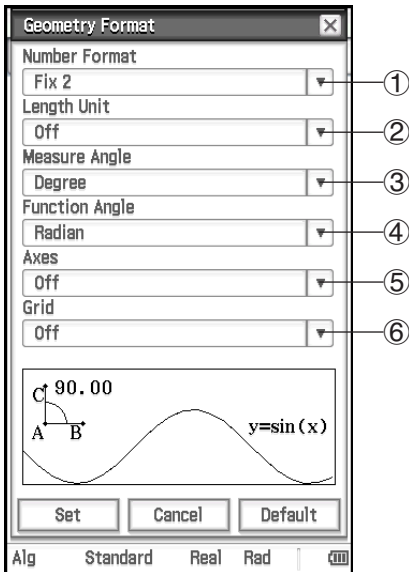

### To specify the Geometry window numeric value display format

Tap ① and then select the format you want. The initial default Number Format setting is Fix2. For more information, see “To specify the numeric value display format” (page 36).

### To specify the unit of the displayed length value

Tap ② and then tap one of the settings described below.

Off\*: Length value unit not displayed.

mm, cm, m, km, in, ft, yd, mi: Displays the length value in the selected unit.

### To specify the angle unit for the measurement box

Tap ③, and then tap “Radian”, “Degree\*”, or “Grad”.

### To specify the angle unit for graphing

Tap ④, and then tap “Radian\*”, “Degree”, or “Grad”.

### To specify the initial status of Graph window axes when the Geometry application is started up

Tap ⑤ and then tap one of the settings described below.

On: Show the axes                      Off\*: Hide the axes

Number: Show the axes along with the maximum and minimum value of each

### To specify the initial status of the grid when the Geometry application is started up

Tap ⑥ and then tap one of the settings described below.

On: Show the grid as dots              Off\*: Hide the grid                      Line: Show the grid as lines

## ■ Advanced Format Dialog Box

Use the Advanced Format dialog box to configure settings for Fourier transform and FFT settings.

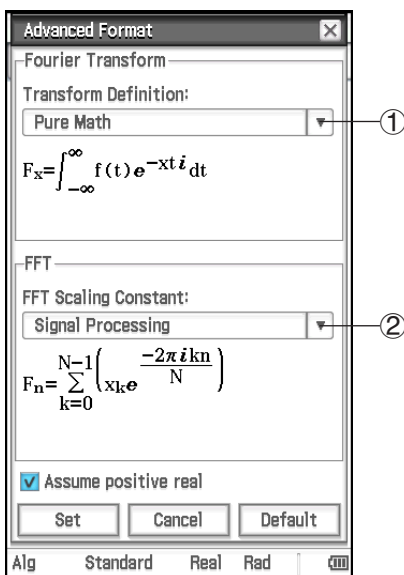

### To specify the Fourier transform formula

Tap ① and then tap “Modern Physics”, “Pure Math\*”, “Probability”, “Classical Physics”, or “Signal Processing”.

### To specify the FFT scaling constant

Tap ② and then tap “Pure Math”, “Signal Processing\*”, or “Data Analysis”.

### To specify how Fourier calculation variables are treated

Select the “Assume positive real” check box\* to specify that Fourier calculation variables should be treated as positive reals only. Clear the check box to specify that complex numbers are allowed for Fourier calculation variables.



## Financial Format Dialog Box

Use the Financial Format dialog box to configure settings for the Financial application.

### [Basic] tab

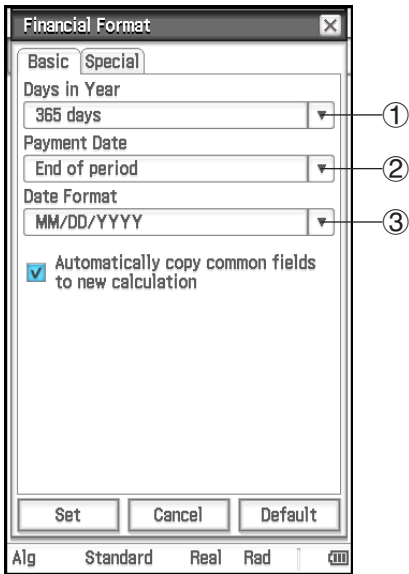

#### To specify the number of days in a year

Tap ①, and then tap “360 days” or “365 days\*\*”.

#### To specify the beginning or the period or the end of the period as the payment date

Tap ② and then tap “Beginning of period” or “End of period\*\*”.

#### To specify the date format

Tap ③ and then tap one of the settings described below.

MM/DD/YYYY\*: month/day/year

DD/MM/YYYY: day/month/year

YYYY/MM/DD: year/month/day

### To specify the status of input fields when starting a new calculation

To do this:	Do this:
When changing to another calculation type, automatically copy the contents of all fields in the current calculation whose names match the names of fields in the new calculation.	Select the [Automatically copy common fields to new calculation] check box*.
When changing to another calculation type, clear all fields.	Clear the [Automatically copy common fields to new calculation] check box.

## [Special] tab

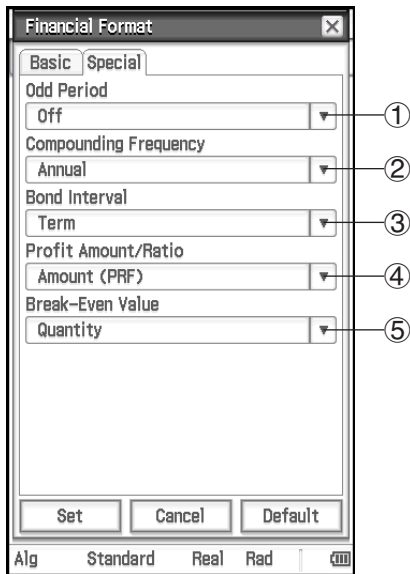

### To specify odd period handling

Tap ① and then tap one of the settings described below.

Compound (CI): Apply compound interest to the odd period when performing a Compound Interest calculation

Simple (SI): Apply simple interest to the odd period when performing a Compound Interest calculation

Off\*: Apply no interest to the odd period when performing a Compound Interest calculation

### To specify the compounding frequency

Tap ②, and then tap “Annual\*” (once a year) or “Semi-annual” (twice a year).

### To specify the bond interval

Tap ③ and then tap one of the settings described below.

Term\*: Specifies use of the number of payments as the duration for bond calculation.

Date: Specifies use of a date as the duration for bond calculation.

### To specify whether to use the amount (PRF) or profit ratio (r%) when performing break-even point calculations

Tap ④, and then tap “Amount (PRF)” or “Ratio (r%)”.

### To specify whether to calculate sales quantity ([QBE]) or sales amount ([SBE]) first when performing break-even point calculations

Tap ⑤, and then tap “Quantity\*” or “Sales”. When “Quantity” is selected, sales quantity can be calculated before calculating the sales amount. When “Sales” is selected, sales amount can be calculated before calculating the sales quantity.

**Tip:** When performing a financial calculation, you can change settings using the Financial application status bar and [Format] tab. For more information, see “Configuring Financial Application Settings” (page 188).

---

## Initializing All Application Format Settings

Perform the following procedure when you want to return all application format settings to their initial defaults.

### • ClassPad Operation

1. Tap  and then tap [Default Setup].
2. In response to the “Reset Setup Data?” message that appears, tap [OK] to initialize all settings.
  - The settings are initialized except for the current folder setting specified on Basic Format dialog box.

## 1-8 When you keep having problems...

If you keep having problems when you are trying to perform operations, try the following before assuming that there is something wrong with the ClassPad.

### 1. Initialize all application format settings.

Perform the procedure under “Initializing All Application Format Settings” (page 42).

### 2. Perform the RAM reset (RESTART) operation.

Perform RAM reset when the ClassPad freezes up or otherwise fails to perform as expected for some reason.

#### To perform the RAM reset operation

##### **Important!**

- The RAM reset operation deletes all data that is temporarily stored in ClassPad RAM. Performing the RAM reset operation while a calculation is in progress will cause any data stored in RAM by the calculation to be lost.
- Perform the RAM reset operation only when your ClassPad freezes up or when it begins to operate abnormally for some reason.

1. Use the stylus to press the RESTART button on the back of the ClassPad.

- Following the RAM reset operation, the ClassPad restarts automatically.

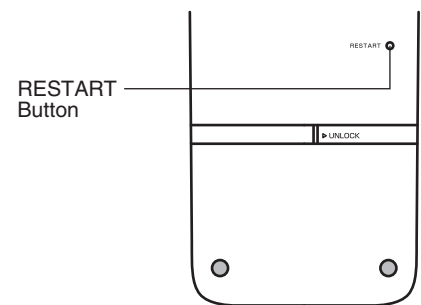

2. After the ClassPad restarts, perform the ClassPad setup operation. For more information about the procedures you need to perform here, see “Loading Batteries and Setting Up the ClassPad” in the separate Quick Start Guide.

- The application menu appears after you finish the setup operation.

### 3. Reset the ClassPad.

Before performing the reset operation, first make a written copy of all important data.

For details, see “To batch delete specific data (Reset)” (page 281).

# Chapter 2: Main Application

The Main application is a general-purpose numerical and mathematical calculation application that you can use to study mathematics and solve mathematical problems. You can use the Main application to perform general operations from basic arithmetic calculations, to calculations that involve lists, matrices, etc.

Starting up the Main application displays a large white work area. Use this area for inputting operations and commands. ClassPad also uses this area to output calculation results.

Basic Main application operations consist of inputting a calculation expression into the work area and pressing **[EXE]**. This performs the calculation and then displays its result on the right side of the work area.

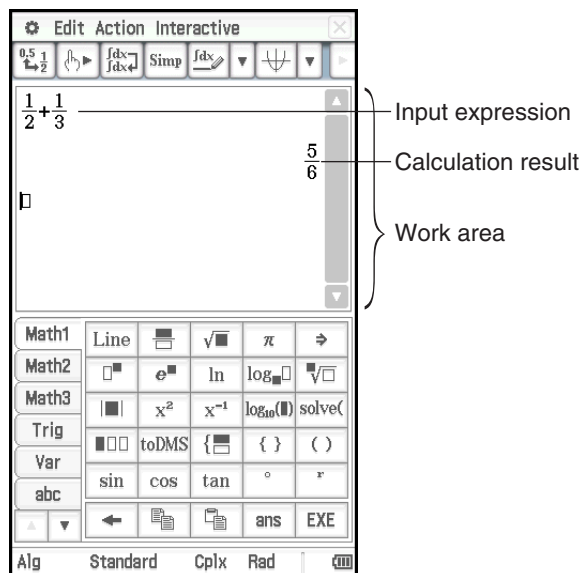

## Main Application-Specific Menus and Buttons

- Clear variables that contain numbers, list and matrices ..... Edit - Clear All Variables
- Insert a command into the work area (page 61) ..... Action
- Execute an Interactive command for the expression selected in the work area (page 91) ..... Interactive
- Toggle calculation result display between the Standard mode and Decimal mode .....
- Recalculate the equation just for the current line where the cursor is currently located .....
- Output an input expression as-is .....
- Insert and execute the Simplify command .....
- Switch between binary, octal, decimal or hexadecimal number bases during normal calculation (page 60) .....
- Access ClassPad application windows from the Main application (page 92) .....

## 2-1 Basic Calculations

This section explains how to perform basic mathematical operations in the Main application.

### Arithmetic Calculations and Parentheses Calculations

You can perform arithmetic calculations by inputting expressions as they are written. The ClassPad automatically judges the calculation priority sequence for addition, subtraction, multiplication, and division, functions, and parentheses.

**0201** Calculation examples

- All of the example calculations shown in **0201** are performed using the keypad or the soft keyboard [Number] key set, unless noted otherwise.
- The example calculations are all performed using the Decimal mode (page 46).

## Using the **EXP** Key

Use the **EXP** key to input exponential values. You can also input exponential values using the **E** key on the soft keyboard [Number] key set.

**0202** Calculation examples

## Omitting the Multiplication Sign

You can omit the multiplication sign in any of the following cases.

- In front of a function...  $2\sin(30)$ ,  $10\log(1.2)$ , etc.
- In front of a constant or variable...  $a\pi$ ,  $2ab$ ,  $3ans$ , etc.
- In front of an open parenthesis...  $3(5 + 6)$ ,  $(a + 1)(b - 1)$ , etc.  
Note that you must use a multiplication sign when the expression directly in front of the open parenthesis is a literal variable. Example:  $ab(3 + b)$  must be written  $ab \times (3 + b)$ . Otherwise, your input is considered to be in function notation ( $f(x)$ ).
- In front of the **EXP** key or **E** key (See “Using the **EXP** Key” above.)
- In front of a matrix or list...  $a\{1, 2, 3\}$ ,  $3[[1, 2][3, 4]]$ , etc.

## Using the Answer Variable (ans)

Any time you execute a calculation in the Main application work area, the last result is assigned automatically to a variable named “ans” (answer). You can even recall current “ans” variable contents and input them into another calculation by tapping the **ans** key on the soft keyboard.

**0203** Calculation examples

**Tip:** Starting a calculation expression with  $+$ ,  $-$ ,  $\times$ ,  $\div$ , or  $\wedge$  operator will cause the “ans” variable to be inserted automatically to the left of the operator, even if you do not tap the **ans** key.

## Assigning a Value to a Variable

Besides using the variable assignment key (**→**, page 33), you can also use the syntax shown below in the Main application and eActivity application to assign a value to a variable.

**Syntax:** Variable: = value

**0204** Assign 123 to variable  $x$

### **Important!**

“:=” can be used only in Main and eActivity. It can NOT be used in a program. In the Program application, you must use **→** to store a value to a variable.

## Calculation Priority Sequence

Your ClassPad automatically performs calculations in the following sequence.

- |   |   |
|---|---|
| ① Commands with parentheses (sin(, diff(, etc.)   | ⑤ +, -, (-)   |
| ② Factorials ( $x!$ ), degree specifications ( $^\circ$ , $^\prime$ ), percents (%)   | ⑥ Relational operators ( $=$ , $\neq$ , $<$ , $>$ , $\leq$ , $\geq$ ) |
| ③ Powers  | ⑦ and   |
| ④ $\pi$ , memory, variable multiplication operations that omit the multiplication sign ( $2\pi$ , $5A$ , etc.), command with parentheses multiplication operations that omit the multiplication sign ( $2\sqrt{3}$ , etc.), $\times$ , $\div$ | ⑧ or, xor   |
|   | ⑨ with (   )  |

### Tip

- Expressions in parentheses are given priority.
- In cases where a series of calculations in the same expression includes more than one of the operators ④ through ⑨ that are the same priority sequence level, the same level operations are performed from left to right. A series of power calculations ③ (example:  $5^2^3$ ) is performed from right to left ( $5^{(2^3)}$ ).

**Example:**  $2 + 3 \times (\log(\sin(2\pi^2)) + 6.8) = 22.07101691$  (In Algebra mode, Decimal mode, Radian mode)

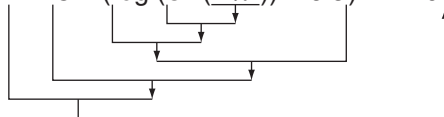

## Calculation Modes

All of the following calculation examples are shown using the Algebra mode only.

### Standard Mode and Decimal Mode

The Standard mode displays calculation results in mathematical expression format whenever possible, while the Decimal mode converts calculation results to a decimal form.

Expression	Decimal Mode Result	Standard Mode Result
$50 \div 4 = 12.5$	12.5	$\frac{25}{2}$
$\sqrt{2} + 2 = 3.414213562\dots$	3.414213562	$2 + \sqrt{2}$
$\pi = 3.1415926535\dots$	3.141592654	$\pi$
$\sin(2.1\pi) \times 5 = 1.5450849718\dots$	1.545084972	$\frac{5 \cdot (\sqrt{5} - 1)}{4}$

- The Decimal mode results in the above table show what would appear on the display when “Normal 1” is selected for the [Number Format] setting on the Basic Format dialog box.

### • Using the Button to Toggle between the Standard Mode and Decimal Mode

You can tap  to toggle a displayed value between Standard mode and Decimal mode format.

Note that tapping  toggles the format of a displayed value. It does not change the current Standard mode and Decimal mode setting.

**0205** Tapping  while the ClassPad is configured for Standard mode (Normal 1) display

**0206** Tapping  while the ClassPad is configured for Decimal mode (Normal 1) display

## • Number of Decimal Places, Number of Significant Digits, Normal Display Settings

The [Number Format] settings on the Basic Format dialog box specify the number of decimal places, the number of significant digits, and the normal display setting for Main application Decimal mode calculation results. The following shows how calculation results appear under each setting.

Expression	Normal 1	Normal 2	Fix 3	Sci 3
$50 \div 4 = 12.5$	12.5	12.5	12.500	$1.25E + 1$
$100 \div 6 = 16.6666666...$	16.66666667	16.66666667	16.667	$1.67E + 1$
$1 \div 600 = 0.00166666...$	$1.666666667E - 3$	0.001666666666	0.002	$1.67E - 3$
$10^{11} \div 4 = 2.5E + 10$	$2.5E + 10$	$2.5E + 10$	$2.5E + 10$	$2.50E + 10$

The allowable range for the number of decimal places is Fix 0 to Fix 9, and the range for the number of significant digits is Sci 0 to Sci 9. For details about the [Number Format] settings, see “Basic Format Dialog Box” on page 36.

## Complex Mode and Real Mode

The Complex mode is for complex number calculations, while the Real mode is limited to calculations within the range of real numbers. Performing a calculation in the Real mode that produces a result that is outside the range of real numbers causes an error (Non-Real in Calc).

**0207** (Complex mode and Real mode calculation results)

### Tip

- You can select “*i*” or “*j*” for the imaginary unit. See “To specify the complex number imaginary unit” on page 283.
- If the expression includes  $\angle(r, \theta)$ , calculation results should be  $\angle(r, \theta)$  form.

## Radian Mode, Degree Mode and Grad Mode

You can specify radians, degrees or grads as the angle unit for display of trigonometric calculation results.

### • Examples of Radian mode, Degree mode and Grad mode calculation results

Expression	Radian Mode	Degree Mode	Grad Mode
$\sin(\pi/4)$	$\frac{\sqrt{2}}{2}$	$\sin\left(\frac{\pi}{4}\right)$	$\sin\left(\frac{\pi}{4}\right)$
$\sin(45)$	$\sin(45)$	$\frac{\sqrt{2}}{2}$	$\sin(45)$
$\sin(50)$	$\sin(50)$	$\sin(50)$	$\frac{\sqrt{2}}{2}$

### Important!

Regardless of the currently selected angle unit setting, a calculation that includes an imaginary number power exponent (such as:  $e^{\pi i}$ ) is performed using radians as the angle unit ( $e^{\pi i} = -1$ ).

## Assistant Mode and Algebra Mode

The Algebra mode automatically simplifies mathematical expressions produced by calculations. No simplification is performed in the Assistant mode. In the Assistant mode, you can view intermediate results as well, which allows you to see the steps that lead to a particular result as shown in **0208** (see the “expand” example).

**0208** (Assistant mode and Algebra mode calculation results)

### Important!

The Assistant mode is available in the Main application and eActivity application only.



## 2-2 Using the Calculation History

The Main application work area calculation history can contain up to 30 expression/result pairs. You can look up a previous calculation, edit, and then re-calculate it, if you want.

- Use the scroll bar or scroll buttons to scroll the work area window up and down. This brings current calculation history contents into view.
- You can edit a calculation expression in the calculation history and then re-calculate the resulting expression. Pressing **[EXE]** re-calculates the expression where the cursor is currently located, and also re-calculates all of the expressions below the current cursor location.

**0209** To change the expression “ans × 2” to “ans × 3” in the example, and then re-calculate

### Tip

- To re-calculate only a single specific line, tap . Tapping  re-calculates the calculation where the cursor is currently located only. It does not affect anything in calculation history that comes before or after the line.
- To re-calculate all of the expressions in the calculation history, locate the cursor in the top line, and then press **[EXE]**.

### • To delete part of the calculation history contents

1. Move the cursor to the expression line or result line of the two-line unit you want to delete.
2. Tap [Edit] and then [Delete].

### Important!

Even if the result of the deleted two-line unit has an effect on subsequent calculations, the affected calculations are not updated automatically following the deletion. When you want to update everything in the calculation history following the deleted unit, move the cursor to a line that is above the one you deleted and then press **[EXE]**.

### • To clear all calculation history contents

Tap [Edit] and then [Clear All]. In response to the confirmation message that appears, tap [OK].

## 2-3 Function Calculations

This section explains how to perform function calculations in the Main application work area.

- You do not need to input the closing parenthesis that comes immediately before an **[EXE]** key operation. All of the calculation examples in this section omit the closing parentheses before **[EXE]**.
- The following example calculations are all performed using the Decimal mode. Using the Standard mode causes results to be displayed as fractions.

### Angle Conversion (°, ′)

The first two examples use “Degree” (indicated by “Deg” in the status bar) as the angle unit setting. The final example uses “Radian” (indicated by “Rad” in the status bar) as the angle unit setting. Note that using the wrong angle unit setting will make it impossible to produce correct calculation results.

### • To change the angle unit setting

1. On the  menu, tap [Basic Format].
2. Tap the [Angle] down arrow button, and then select [Radian], [Degree] or [Grad].
  - You can also change the angle unit setting by tapping the current setting (Rad, Deg, or Gra) on the status bar. Each tap will cycle through the available settings.



Problem	Operation
Convert 4.25 radians to degrees. = 243.5070629	4.25 $\frac{\pi}{180}$ [EXE]
$47.3^\circ + 82.5\text{rad} = 4774.20181^\circ$	47.3 + 82.5 $\frac{\pi}{180}$ [EXE]
How many radians is $243.5070629^\circ$ ? = 4.249999999	Change the [Angle] setting to "Radian", and then input $243.5070629 \frac{\pi}{180}$ [EXE].

## Trigonometric and Inverse Trigonometric Functions

Problem	Operation
$\cos\left(\frac{\pi}{3}\right) \text{ rad} = 0.5$	Change the [Angle] setting to "Radian". [cos] $\frac{\pi}{180}$ $\div$ 3 [EXE] or [cos] $\frac{\pi}{180}$ $\downarrow$ 3 [EXE]
$2 \cdot \sin 45^\circ \times \cos 65^\circ = 0.5976724775$	Change the [Angle] setting to "Degree". 2 [x] [sin] 45 [)] [x] [cos] 65 [EXE] Can be omitted.
$\sin^{-1} 0.5 = 30^\circ$ (Determine $x$ for $\sin x = 0.5$ .)	[sin <sup>-1</sup> ] 0.5 [EXE] ".5" can also be used.

## Logarithmic Functions and Exponential Functions

Problem	Operation
$\log_{10} 1.23 = 0.08990511144$	[log <sub>10</sub> ] 1.23 [EXE] or [log <sub>10</sub> ] 10 [▶] 1.23 [EXE]
$\ln 90 = 4.49980967$	[ln] 90 [EXE] or [log <sub>e</sub> ] e [▶] 90 [EXE]
$\log_3 9 = 2$	[log <sub>3</sub> ] 3 [▶] 9 [EXE] or [Line] [log <sub>3</sub> ] 3 ['] 9 [EXE]
$e^{4.5} = 90.0171313$	[e <sup>x</sup> ] 4.5 [EXE]
$(-3)^4 = (-3) \times (-3) \times (-3) \times (-3) = 81$	[(-)] 3 [)] [^] 4 [EXE]
$\sqrt[7]{123} (= 123^{\frac{1}{7}}) = 1.988647795$	123 [^] [ ( ] 1 [ ÷ ] 7 [EXE] or [√] 7 [▶] 123 [EXE]

## Hyperbolic and Inverse Hyperbolic Functions

Problem	Operation
$\sinh 3.6 = 18.28545536$	[sinh] 3.6 [EXE]
$\cosh^{-1} \left(\frac{20}{15}\right) = 0.7953654612$	[cosh <sup>-1</sup> ] 20 [ ÷ ] 15 [EXE] or [cosh <sup>-1</sup> ] $\frac{20}{15}$ $\downarrow$ 15 [EXE]

## Other Functions (% , $\sqrt{\quad}$ , $x^2$ , $x^{-1}$ , $x!$ , abs, $\angle$ , signum, int, frac, intg, fRound, sRound)

Problem	Operation
What is 12% of 1500? (180)	1500 $\times$ 12 % EXE
What percent of 880 is 660? (75%)	660 $\div$ 880 % EXE
What value is 15% greater than 2500? (2875)	2500 $\times$ ( 1 + 15 %
What value is 25% less than 3500? (2625)	3500 $\times$ ( 1 - 25 %
$\sqrt{2} + \sqrt{5} = 3.65028154$	$\sqrt{\square}$ 2 $\rightarrow$ + $\sqrt{\square}$ 5 EXE
$\sqrt{(3 + i)} = 1.755317302 + 0.2848487846i$	Change to the Complex mode (“Cplx” indicated on the status bar). $\sqrt{\square}$ 3 + i EXE
$(-3)^2 = (-3) \times (-3) = 9$	( (-) 3 ) $x^2$ EXE
$-3^2 = -(3 \times 3) = -9$	(-) 3 $x^2$ EXE
$\frac{1}{\frac{1}{3} - \frac{1}{4}} = 12$	( 3 $x^{-1}$ - 4 $x^{-1}$ ) $x^{-1}$ EXE or $\frac{\square}{\square}$ 1 $\downarrow$ $\frac{\square}{\square}$ 1 $\downarrow$ 3 $\rightarrow$ - $\frac{\square}{\square}$ 1 $\downarrow$ 4 EXE
$8! (= 1 \times 2 \times 3 \times \dots \times 8) = 40320$	8 ! EXE
What is the absolute value of the common logarithm of $\frac{3}{4}$ ? $ \log(\frac{3}{4})  = 0.1249387366$	$\log_{\square}$ 10 $\rightarrow$ $\frac{\square}{\square}$ 3 $\downarrow$ 4 EXE or Line $\log_{\square}$ 3 $\div$ 4 EXE
$8 \angle 40^\circ \times 5 \angle 35^\circ$ $\angle(8,40) \times \angle(5,35) = \angle(40,75)$	Change to the Degree mode (“Deg” indicated on the status bar). $\angle$ 8 , 40 $\rightarrow$ $\times$ $\angle$ 5 , 35 $\rightarrow$ EXE
What is the sign of $-3.4567$ ? (-1) (signum returns $-1$ for a negative value, $1$ for a positive value, “Undefined” for $0$ , and $\frac{A}{ A }$ for an imaginary number.)	[signum] (-) 3.4567 EXE
What is the integer part of $-3.4567$ ? (-3)	[int] (-) 3.4567 EXE
What is the decimal part of $-3.4567$ ? (-0.4567)	[frac] (-) 3.4567 EXE
What is the greatest integer less than or equal to $-3.4567$ ? (-4)	[intg] (-) 3.4567 EXE
What is $-3.4567$ rounded to two decimal places? (-3.46)	[fRound] (-) 3.4567 , 2 EXE
What is $-34567$ rounded to four significant digits? (-34570)	[sRound] (-) 34567 , 4 EXE *

\* To round to 10 digits, specify “0” for the second argument.

## Random Number Generator (rand, randList, randNorm, randBin, RandSeed)

The ClassPad random number generator can generate truly random numbers (non-sequential random numbers) and random numbers that follow a particular pattern (sequential random numbers).

### • To switch between non-sequential and sequential random number generation

1. Use the “RandSeed” command to configure random number generation settings. See “RandSeed Command” on page 52.
2. Use the “rand”, “randList”, “randNorm”, or “randBin” function to generate the random numbers.

### • “rand” Function

The “rand” function generates random numbers. If you do not specify an argument, “rand” generates 10-digit decimal values 0 or greater and less than 1. Specifying two integer values for the argument generates random numbers between them.

Problem	Operation
Generate random numbers between 0 and 1.	[rand] <input type="text" value="EXE"/>
Generate random integers between 1 and 6.	[rand] <input type="text" value="1"/> <input type="text" value=","/> <input type="text" value="6"/> <input type="text" value="EXE"/>

### • “randList” Function

**Syntax:** randList(*n* [, a, b])

**Function:**

- Omitting arguments “a” and “b” returns a list of *n* elements that contain decimal random values.
- Specifying arguments “a” and “b” returns a list of *n* elements that contain integer random values in the range of “a” through “b”.

**Description:**

- “*n*” must be a positive integer.
- The random numbers of each element are generated in accordance with “RandSeed” specifications.

Problem	Operation
Generate a list of three elements that contain decimal random values.	[randList] <input type="text" value="3"/> <input type="text" value="EXE"/>
Generate a list of five elements that contain random values in the range of 1 through 6.	[randList] <input type="text" value="5"/> <input type="text" value=","/> <input type="text" value="1"/> <input type="text" value=","/> <input type="text" value="6"/> <input type="text" value="EXE"/>

### • “randNorm” Function

The “randNorm” function generates a 10-digit normal random number based on a specified standard deviation  $\sigma$  and mean  $\mu$  values.

**Syntax:** randNorm( $\sigma$ ,  $\mu$  [, *n*])

**Function:**

- Omitting a value for “*n*” (or specifying 1 for “*n*”) returns the generated random number as-is.
- Specifying 2 or larger value for “*n*” returns the specified number of random values in list format.

**Description:**

- “*n*” must be a positive integer, and “ $\sigma$ ” must be greater than 0.

Problem	Operation
Randomly produce a body length value obtained in accordance with the normal distribution of a group of infants less than one year old with a mean body length of 68 cm and standard deviation of 8.	[randNorm] <input type="text" value="8"/> <input type="text" value=","/> <input type="text" value="68"/> <input type="text" value="EXE"/>
Randomly produce the body lengths of five infants in the above example, and display them in a list.	[randNorm] <input type="text" value="8"/> <input type="text" value=","/> <input type="text" value="68"/> <input type="text" value=","/> <input type="text" value="5"/> <input type="text" value="EXE"/>

### • “randBin” Function

The “randBin” function generates binomial random numbers based on values specified for the number of trials *n* and probability P.

**Syntax:** randBin(*n*, P [, *m*])

**Function:**

- Omitting a value for “*m*” (or specifying 1 for “*m*”) returns the generated random number as-is.
- Specifying 2 or larger value for “*m*” returns the specified number of random values in list format.

**Description:**

- “*n*” and “*m*” must be positive integers.

Problem	Operation
Randomly produce the number of heads that can be expected in accordance with binomial distribution for five coin tosses where the probability of heads is 0.5.	[randBin] 5 [ ] , 0.5 [EXE]
Perform the same coin toss sequence described above three times and display the results in a list.	[randBin] 5 [ ] , 0.5 [ ] , 3 [EXE]

• **“RandSeed” Command**

- You can specify an integer from 0 to 9 for the argument of this command. 0 specifies non-sequential random number generation. An integer from 1 to 9 uses the specified value as a seed for specification of sequential random numbers. The initial default argument for this command is 0.
- The numbers generated by the ClassPad immediately after you specify sequential random number generation always follow the same random pattern.

Problem	Operation
Generate sequential random numbers using 3 as the seed value.	[RandSeed] 3 [EXE]
Generate the first value.	[rand] [EXE]
Generate the second value.	[rand] [EXE]
Generate the third value.	[rand] [EXE]

**Tip**

- Random values generated by these commands are pseudo random values.
- The arguments *a* and *b* of “rand(*a*,*b*)” and “randList(*n*,*a*,*b*)” must be integers, subject to the following conditions.

$$a < b \quad |a|, |b| < 1 \times 10^9 \quad b - a < 1 \times 10^9$$

**Integer Functions**

These functions take integers only as their arguments and return integers.

• **“iGcd” Function**

**Syntax:** iGcd(Exp-1, Exp-2[, Exp-3...Exp-10])  
 (Exp-1 through Exp-10 all are integers.)  
 iGcd(List-1, List-2[, List-3...List-10])  
 (All elements of List-1 through List-10 are integers.)

**Function:**

- The first syntax above returns the greatest common divisor for two to ten integers.
- The second syntax returns, in list format, the greatest common divisor (GCD) for each of the elements in two to ten lists. When the arguments are {*a*,*b*}, {*c*,*d*}, for example, a list will be returned showing the GCD for *a* and *c*, and for *b* and *d*.

**Description:**

- All of the lists must have the same number of elements.
- When using the “iGcd(List-1, List-2[, List-3...List-10])” syntax, one (and only one) expression (Exp) can be include as an argument in place of a list.

Problem	Operation
Determine the greatest common divisors of {4, 3}, {12, 6}, and {36, 9}.	[iGcd] [ { 4 , 3 } , { 12 , 6 } , { 36 , 9 } ] ) EXE

### • “iLcm” Function

**Syntax:** iLcm(Exp-1, Exp-2[, Exp-3...Exp-10])  
 (Exp-1 through Exp-10 all are integers.)  
 iLcm(List-1, List-2[, List-3...List-10])  
 (All elements of List-1 through List-10 are integers.)

#### Function:

- The first syntax above returns the least common multiple for two to ten integers.
- The second syntax returns, in list format, the least common multiple (LCM) for each of the elements in two to ten lists. When the arguments are {a,b}, {c,d}, for example, a list will be returned showing the LCM for a and c, and for b and d.

#### Description:

- All of the lists must have the same number of elements.
- When using the “iLcm(List-1, List-2[, List-3...List-10])” syntax, one (and only one) expression (Exp) can be include as an argument in place of a list.

Problem	Operation
Determine the least common multiples of {4, 3}, {12, 6}, and {36, 9}.	[iLcm] [ { 4 , 3 } , { 12 , 6 } , { 36 , 9 } ] ) EXE

### • “iMod” Function

**Syntax:** iMod(Exp-1/List-1, Exp-2/List-2[.])

#### Function:

- This function divides one or more integers by one or more other integers and returns the remainder(s).

#### Description:

- Exp-1 and Exp-2, and all of the elements of List-1 and List-2 must be integers.
- You can use Exp for one argument and List for the other argument (Exp, List or List, Exp) if you want.
- If both arguments are lists, both lists must have the same number of elements.

Problem	Operation
Divide 21 by 6 and 7, and determine the remainder of both operations. (iMod(21, {6, 7}))	[iMod] 21 [ , { 6 , 7 } ] ) EXE

### Permutation ( $nPr$ ) and Combination ( $nCr$ )

• **Total Number of Permutations**  $nPr = \frac{n!}{(n-r)!}$

• **Total Number of Combinations**  $nCr = \frac{n!}{r!(n-r)!}$

Problem	Operation
To determine the number of permutations and combinations possible when selecting four people from a group of 10	${}_{10}P_4 = 5040$ $\boxed{nPr} \ 10 \ , \ 4 \ \boxed{EXE}$
	${}_{10}C_4 = 210$ $\boxed{nCr} \ 10 \ , \ 4 \ \boxed{EXE}$

## Condition Judgment (judge, piecewise)

### • “judge” Function

The “judge” function returns TRUE when an expression is true, and FALSE when it is false.

Problem	Operation
Is the following expression true or false? $1 = 1$ TRUE	[judge] 1 [=] 1 [EXE]
Is the following expression true or false? $1 < 0$ FALSE	[judge] 1 [<] 0 [EXE]

### • “piecewise” Function

The “piecewise” function returns one value when an expression is true, and another value when the expression is false.

The syntax of the “piecewise” function is shown below.



piecewise(<condition expression>, <return value when true>, <return value when false or indeterminate> [ ] ]

or

piecewise(<condition expression>, <return value when true>, <return value when false>, <return value when indeterminate> [ ] ]

Use the soft keyboard () to input “piecewise” function according to the syntax shown below.

$\left\{ \begin{array}{l} \text{<return value when true>, <condition expression> \\ \text{<return value when false or indeterminate>} \end{array} \right.$   
 or  
 $\left\{ \begin{array}{l} \text{<return value when condition 1 is true>, <condition 1 expression> \\ \text{<return value when condition 2 is true>, <condition 2 expression>} \end{array} \right.$

Problem	Operation
For the expression $0 \geq x$ ( $x = \text{variable}$ ), return 1 when $x$ is 0 or less, and 2 when $x$ is greater than 0 or undefined.	[piecewise] 0 [≥] [∞] [,] 1 [,] 2 [EXE] or  1 [▼] 2 [▶] [▲] 0 [≥] [∞] [EXE]
For the expression $1 \geq x$ ( $x = \text{variable}$ ), return 1 when $x$ is 1 or less, and 2 when $x$ is greater than 1.	 1 [▼] 2 [▶] [▲] 1 [≥] [∞] [▼] 1 [<] [∞] [EXE]

## Angle Symbol ( $\angle$ )

Use this symbol to specify the coordinate format required by an angle in a vector.

You can use this symbol for a vector only.

Problem	Operation
Convert the polar coordinates $r = \sqrt{2}$ , $\theta = \pi/4$ to rectangular coordinates. [1, 1]	Change the [Angle] setting to “Radian”. [toRect] [ ] [√] 2 [▶] [,] [∠] [π] [÷] 4 [ ) ] [ ] [EXE]

## Derivative Symbol (')

A single derivative symbol indicates the first derivative of an equation in the format: <variable name>'.

Problem	Operation
Solve the differential equation $y' = x$ . { $y = 0.5 \cdot x^2 + \text{const}$ (1)}	[dSlv] [y] ['] [=] [x] [,] [x] [,] [y] [EXE]

### Important!

The “dSolve” function can solve differential equations up to three degrees, so a maximum of three derivative symbols ( $y'''$ ) can be used. Executing a “dSolve” calculation that has more than three derivative symbols will result in an Invalid Syntax error.

## Primality Test (isPrime)

The “isPrime” function determines whether the number provided as the argument is prime (returns TRUE) or not (returns FALSE). The syntax of the “isPrime” function is shown below.

isPrime(Exp/List[ ] )

- Exp or all of the elements of List must be integers.

Problem	Operation
Determine whether the numbers 51 and 17 are prime. (isPrime({51, 17}))	[isPrime] [ { ] 51 [ , ] 17 [ } ] [ ) ] [ EXE ]

## Equal Symbols and Unequal Symbols (=, ≠, <, >, ≤, ≥)

You can use these symbols to perform a number of different basic calculations.

Problem	Operation
To add 3 to both sides of $x = 3$ . $x + 3 = 6$	[ ( ] [ x ] [ = ] 3 [ ) ] [ + ] 3 [ EXE ]
Subtract 2 from both sides of $y \leq 5$ . $y - 2 \leq 3$	[ ( ] [ y ] [ ≤ ] 5 [ ) ] [ - ] 2 [ EXE ]

### Tip

- In the “Syntax” explanations of each command under “2-7 Using the Action Menu”, the following operators are indicated as “Eq/Ineq”: =, ≠, <, >, ≤, ≥. Whether or not the “Eq/Ineq” operators include the “≠” operator is specified for each command by a separate note.
- An expression that contains multiple equation or inequality operators cannot be input as a single expression. For output expressions, an expression can be output with multiple operators only in the case of inequality operators that are facing in the same direction (example:  $-1 < x < 1$ ).

**Example:** solve( $x^2 - 1 < 0$ , x) [ EXE ] { $-1 < x < 1$ }

## “with” Operator ( | )

The “with” ( | ) operator temporarily assigns a value to a variable. You can use the “with” operator in the following cases.

- To assign the value specified on the right side of | to the variable on the left side of |
- To limit or restrict the range of a variable on the left side of | in accordance with conditions provided on the right side of |

The following is the syntax for the “with” ( | ) operator.

Exp/Eq/Ineq/List/Mat|Eq/Ineq/List/(and operator)

You can put plural conditions in a list or connected with the “and” operator on the right side.

“≠” can be used on the left side or the right side of |.

Problem	Operation
Evaluate $x^2 + x + 1$ when $x = 3$ . 13	[ x ] [ ^ ] 2 [ + ] [ x ] [ + ] 1 [   ] [ x ] [ = ] 3 [ EXE ]
For $x^2 - 1 = 0$ , determine the value of $x$ when $x > 0$ . { $x = 1$ }	solve( [ x ] [ ^ ] 2 [ - ] 1 [ = ] 0 [ , ] [ x ] [ ) ] [   ] [ x ] [ > ] 0 [ EXE ]
For $x^2 - 1 = 0$ , determine the value of $x$ when $-2 < x < 2$ . { $x = -1, x = 1$ }	solve( [ x ] [ ^ ] 2 [ - ] 1 [ = ] 0 [ , ] [ x ] [ ) ] [   ] [ ( - ) ] 2 [ < ] [ x ] [ Space ] [ a ] [ n ] [ d ] [ Space ] [ x ] [ < ] 2 [ EXE ]
Determine the value of abs ( $x$ ) when $x > 0$ . $x$	[ abs ] [ x ] [   ] [ x ] [ > ] 0 [ EXE ]

## Solutions Supported by ClassPad (TRUE, FALSE, Undefined, No Solution, ∞, const, constn)

Solution	Description	Example
TRUE	Output when a solution is true.	judge (1 = 1)
FALSE	Output when a solution is false.	judge (1 < 0)
Undefined	Output when a solution is undefined.	1/0
No Solution	Output when there is no solution.	solve (abs (x) = -1, x)
∞	Infinity	lim (1/x <sup>2</sup> , x, 0)
const	Constant displayed as const(1) when any value that is a constant is included in the solution. In the case of multiple constants, they are indicated as const(1), const(2), and so on.	dSolve (y' = x, x, y) {y = 0.5·x <sup>2</sup> + const (1)}
constn	Constant displayed as constn(1) when the solution includes any integer value that is a constant. In the case of multiple constants, they are indicated as constn(1), constn(2), and so on.	Change the [Angle] setting to "Degree". solve (sin (x) = 0, x) {x = 180·constn (1)}

### Dirac Delta Function

"delta" is the Dirac Delta function. The delta function evaluates numerically as shown below.

$$\delta(x) = \begin{cases} 0, & x \neq 0 \\ \delta(x), & x = 0 \end{cases}$$

Non-numeric expressions passed to the delta function are left unevaluated. The integral of a linear delta function is a Heaviside function.

**Syntax:** delta(*x*)  
*x* : variable or number

**0210** (Calculation example screenshot)

### *n*th-Delta Function

The *n*th-delta function is the *n*th differential of the delta function.

**Syntax:** delta(*x*, *n*)  
*x* : variable or number  
*n* : number of differentials

**0211** (Calculation example screenshot)

### Heaviside Unit Step Function

"heaviside" is the command for the Heaviside function, which evaluates only to numeric expressions as shown below.

$$H(x) = \begin{cases} 0, & x < 0 \\ \frac{1}{2}, & x = 0 \\ 1, & x > 0 \end{cases}$$

Any non-numeric expression passed to the Heaviside function will not be evaluated, and any numeric expression containing complex numbers will return undefined. The derivative of the Heaviside function is the Delta function.

**Syntax:** heaviside(*x*)  
*x* : variable or number

**0212** (Calculation example screenshot)



## Gamma Function

The Gamma function is called “gamma” on the ClassPad.

$$\Gamma(x) = \int_0^{+\infty} t^{x-1} e^{-t} dt$$

For an integer  $n$  the gamma is evaluated as shown below.

$$\Gamma(n) = \begin{cases} (n-1)!, & n > 0 \\ \text{undefined}, & n \leq 0 \end{cases}$$

The gamma is defined for all real numbers excluding zero and negative integers. It is also defined for all complex numbers where either the real or imaginary part of the complex number is not an integer. Gamma of a symbolic expression returns unevaluated.

**Syntax:** gamma( $x$ )  
 $x$  : variable or number

**0213** (Calculation and graph example screenshots)

## 2-4 List Calculations

This section explains how to input list data, and how to perform basic list calculations.

---

### Inputting List Data in the Work Area

**0214** To input the list {1, 2, 3} and assign it to LIST variable “lista” in the Main application work area

---

### LIST Variable Element Operations

You can recall the value of any element of a LIST variable. You can also assign a value to any element in a list.

**0215** To recall the second element of the “lista” list variable of example **0214**

**0216** To assign 5 to the second element of “lista”

---

### Using a List in a Calculation

You can perform arithmetic operations between two lists, between a list and a numeric value, or between a list and an expression, equation, or inequality.

#### **Important!**

- When you perform an arithmetic operation between two lists, both of the lists need to have the same number of elements. An error will occur if they do not.
- An error will also occur whenever an operation between any two elements of the two lists results in an error.

**0217** Perform the operation list3  $\times$  {6, 0, 4} when list3 contains {41, 65, 22}

---

### Using a List to Assign Different Values to Multiple Variables

Use the procedure in this section when you want to use a list to assign various different values to multiple variables.

**Syntax:** List with Numbers  $\Rightarrow$  List with Variables

**0218** Assign the values 10, 20, and 30, to variables  $x$ ,  $y$ , and  $z$  respectively

## 2-5 Matrix and Vector Calculations

This section explains how to create matrices, and how to perform basic matrix calculations.

**Tip:** Since a vector can be viewed as 1-row by  $n$ -column matrix or  $n$ -row by 1-column matrix, this section does not include explanations specifically about vectors. For more information about vector-specific calculations, see the explanations about the applicable [Action] menu items in “2-7 Using the Action Menu”.

---

### Inputting Matrix Data

You can input matrix values in a single line in the work area, or input matrix values using an actual on-screen matrix.

#### Inputting Matrix Values in a Single Line

**0219** To input the matrix  $\begin{bmatrix} 1 & 2 \\ 3 & 4 \end{bmatrix}$  and assign it to the variable “mat1” in the Main application work area







#### Matrix Variable Element Operations

You can recall the value of any element of a matrix variable. You can also assign a value to any element in a matrix.

**0220** To recall the value in row 2, column 1 of the matrix variable “mat1” of example **0219**

**0221** To assign 5 to the element at row 1, column 2 of “mat1”

#### Inputting Matrix Values Using an Actual On-Screen Matrix

- Create a new 1-row × 2-column matrix ..... 
- Create a new 2-row × 1-column matrix ..... 
- Create a new 2-row × 2-column matrix ..... 
- Add a column to the currently displayed matrix ..... 
- Add a row to the currently displayed matrix ..... 
- Add both a row and column to the currently displayed matrix ..... 

**0222** To input the matrix  $\begin{bmatrix} 1 & 2 & 3 \\ 4 & 5 & 6 \end{bmatrix}$  and assign it to the variable “mat2”

---

### Performing Matrix Calculations

This section provides examples of how to perform the most basic types of matrix calculations.

#### Matrix Addition, Subtraction, Multiplication, and Division

**0223** To calculate  $\begin{bmatrix} 1 & 1 \\ 2 & 1 \end{bmatrix} + \begin{bmatrix} 2 & 3 \\ 2 & 1 \end{bmatrix}$  in a single line

**0224** To calculate  $\begin{bmatrix} 1 & 1 \\ 2 & 1 \end{bmatrix} \times \begin{bmatrix} 2 & 3 \\ 2 & 1 \end{bmatrix}$  using an actual on-screen matrix

**0225** To multiply the matrix  $\begin{bmatrix} 1 & 2 \\ 3 & 4 \end{bmatrix}$  by 5

## Raising a Matrix to a Specific Power

**Example:** To raise  $\begin{bmatrix} 1 & 2 \\ 3 & 4 \end{bmatrix}$  to the power of 3

**0226** Input in a single line

**0227** Input using an actual on-screen matrix

**Tip:** You can raise only a square matrix to a specific power. An error occurs when you try to raise a non-square matrix to a specific power.

## Using a Matrix to Assign Different Values to Multiple Variables

Use the procedure in this section when you want to use a matrix to assign various different values to multiple variables.

**Syntax:** Matrix with Numbers  $\Rightarrow$  Matrix with Variables  
(The matrix can be one line with multiple columns, or multiple lines with one column.)

**0228** Assign the values 10, 20, and 30, to variables  $x$ ,  $y$ , and  $z$  respectively

## 2-6 Specifying a Number Base

While using the Main application, you can specify a default number base (binary, octal, decimal, hexadecimal). You can also convert between number bases and perform bitwise operations using logical operators (not, and, or, xor).

Note the following limitations, which all apply while a default number base (binary, octal, decimal, hexadecimal) is specified in the Main application.

- You cannot use scientific functions, or [Action] or [Interactive] menu commands.
- Except for Ans (Answer Memory variable), you cannot use variables.
- You can input integers only. An error (Invalid Syntax) will occur if you try to input a non-integer value (like 1.5 or  $\sqrt{2}$ ).
- If a calculation produces a non-integer result (with a decimal part), the ClassPad will cut off the decimal part automatically. For example, the calculation  $5 \div 2$  while decimal is selected as the number base is 2.
- An error message is displayed if you try to enter a value that is invalid for the specified number base. The following shows the numerals that can be used in each number system.

**Binary:** 0, 1      **Octal:** 0 to 7      **Decimal:** 0 to 9      **Hexadecimal:** 0 to 9, A, B, C, D, E, F

## Binary, Octal, Decimal, and Hexadecimal Calculation Ranges

- The following are the display capacities and calculation ranges for each of the number bases.

Number Base	Display Capacity	Calculation Range (Positive ; Negative)
Binary	32 digits	$0 \leq x \leq 01111111111111111111111111111111$ ; $10000000000000000000000000000000 \leq x \leq$ $11111111111111111111111111111111$
Octal	11 digits	$0 \leq x \leq 17777777777$ ; $2000000000 \leq x \leq 3777777777$
Decimal	10 digits	$0 \leq x \leq 2147483647$ ; $-2147483648 \leq x \leq -1$
Hexadecimal	8 digits	$0 \leq x \leq 7FFFFFFF$ ; $80000000 \leq x \leq FFFFFFFF$





- Negative binary, octal, and hexadecimal values are produced using the two's complement of the original value.

---

## Selecting a Number Base

Specifying a default number base in the Main application will apply to the current line (expression/result pair), and to all subsequent lines until you change the default number base setting.

### • To select the number base for the line where the cursor is located

1. Tap the down arrow button next to the  button.
  2. Tap the button that corresponds to the number base you want to use:  
 (binary),  (octal),  (decimal),  (hexadecimal).
- The currently selected number base is indicated in the status bar.

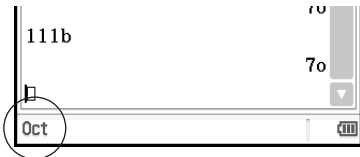

3. Execute the calculation.

### **Important!**

- A line for which a number base is not specified is called a “normal calculation line”. To return a line to a normal calculation line, tap  in step 2 of the above procedure.
- Calculation results produced by a line for which a number base is specified are followed by one of the suffixes listed below, to indicate its number system.

Number System	Binary	Octal	Decimal	Hexadecimal
Suffix	b	o	d	h

### • To specify a number base for an input value

You can input the following suffixes to specify the number base of a value as you input it: [b] (binary), [o] (octal), [d] (decimal), and [h] (hexadecimal). You can specify a number base for an input value only when a default number base (besides normal) is selected

---

## Arithmetic Operations

You can use the following operators when performing binary, octal, decimal and hexadecimal values: +, −, ×, ÷, ^. You can also use parenthetical expressions.

**0229** To calculate  $10111_2 + 11010_2$

**0230** To calculate  $(11_8 + 7_8)^2$

**0231** Perform the calculation  $123_{10} + 1010_2$  so it produces a hexadecimal result

---

## Bitwise Operations

The logical operators (and, or, xor, not) can be used in calculations.

and... Returns the result of a bitwise product.

or..... Returns the result of a bitwise sum.

xor.... Returns the result of a bitwise exclusive logical sum.

not.... Returns the result of a complement (bitwise inversion).

**0232** Calculation examples

---

## Using the baseConvert Function (Number System Transform)

The baseConvert function lets you convert a number in one base (number system) to its equivalent in another base.

### **Important!**

- The baseConvert function works for positive integers only.
- The baseConvert function cannot be used in a line for which a particular number base is specified. It can be used in a normal calculation line only.

**Syntax:** baseConvert (Number, Current base, Expected base)

- Number must be a positive integer consisting of digits 0 to 9 and/or A to F.
- The current base and expected base can be any whole number from 2 to 16.

**0233** Calculation examples

## 2-7 Using the Action Menu

The [Action] menu helps to make transformation and expansion functions, calculus functions, statistical functions, and other frequently used mathematical menu operations easier to use. Simply select the function you want, and then enter expressions or variables in accordance with the syntax of the function.

### **Tip**

- Unless specifically indicated otherwise, all of the explanations in this section are performed using the following modes: Algebra mode, Standard mode, Complex mode, Radian mode, Descending Order.
- You can use the [Interactive] menu to select most of the commands that are included on the [Action] menu. For details about using the [Interactive] menu, see page 91.

---

## Abbreviations and Punctuation Used in This Section

The following are the meanings of the abbreviations and punctuation used in the syntax descriptions in this section.

- |   |                    |
|---|--------------------|
| <b>Exp:</b> Expression (Value, Variable, etc.)  | <b>List:</b> List  |
| <b>Eq:</b> Equation   | <b>Mat:</b> Matrix |
| <b>Ineq:</b> All types of inequalities ( $a > b$ , $a \geq b$ , $a < b$ , $a \leq b$ , $a \neq b$ ) |                    |
| <b>Ineq<math>\neq</math>:</b> Inequality $a \neq b$ only  |                    |
| <b>[ ]:</b> You can omit the item(s) inside the brackets.   |                    |
| <b>{ }:</b> Select one of the items inside the braces.  |                    |

Some of the syntaxes in the following explanations indicate the following for parameters:

Exp/Eq/Ineq/List/Mat

These abbreviations mean that you can use any of the following as a parameter: expression, equation, inequality, list, or matrix.

---

## Example Screenshots

The screenshots below show examples of how input and output expressions appear on the ClassPad display. All of the screenshots in this section show the “complete expression” version.

### When the input expression does not fit:

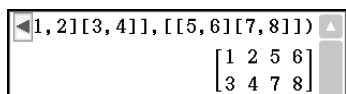

Displayed expression

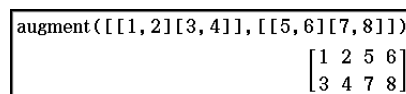

Complete expression

### When the output expression does not fit:

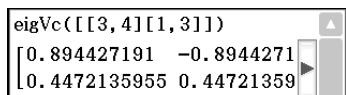

Displayed expression

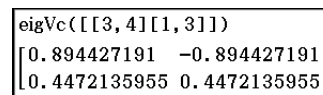

Complete expression

---

## Using the Transformation Submenu

The [Transformation] submenu contains commands for expression transformation, like “expand” and “factor”.

- **approx** [Action][Transformation][approx]

Function: Transforms an expression into a numerical approximation.

Syntax: approx (Exp/Eq/Ineq/List/Mat [ ] )

Example: To obtain the numerical value of  $\sqrt{2}$

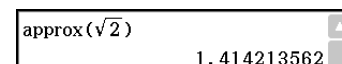

- **simplify** [Action][Transformation][simplify]

Function: Simplifies an expression.

Syntax: simplify (Exp/Eq/Ineq/List/Mat [ ] )

Example: To simplify  $(15\sqrt{3} + 26)^{1/3}$

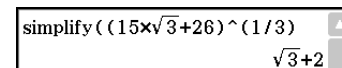

- **expand** [Action][Transformation][expand]

Function: Expands an expression.

Syntax: expand (Exp/Eq/Ineq/List/Mat [ ] )  
expand (Exp,variable [ ] )

• If you specify a variable, Exp is decomposed into partial fractions, with respect to the variable.

Example: To expand  $(x + 2)^2$

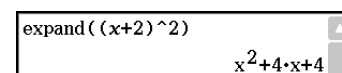

- **factor** [Action][Transformation][factor][factor]

Function: Factors an expression.

Syntax: factor (Exp/Eq/Ineq/List/Mat [ ] )

Example: To factor  $x^2 - 4x + 4$

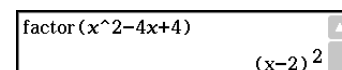

• **rFactor** [Action][Transformation][factor][rFactor]

Function: Factors an expression up to its roots, if any.

Syntax: rFactor (Exp/Eq/Ineq/List/Mat [ ] )

Example: To factor  $x^2 - 3$

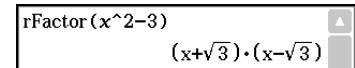

```
rFactor(x^2-3)
(x+sqrt(3)) * (x-sqrt(3))
```

• **factorOut** [Action][Transformation][factor][factorOut]

Function: Factors out an expression with respect to a specified factor.

Syntax: factorOut (Exp/Eq/Ineq/List/Mat, Exp [ ] )

Example: To factor “a” out  $ax^2 + bx + c$

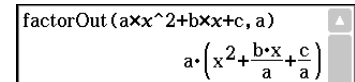

```
factorOut(a*x^2+b*x+c, a)
a * (x^2 + b*x/a + c/a)
```

• **combine** [Action][Transformation][combine]

Function: Transforms multiple fractions into their common denominator equivalents and reduces them, if possible.

Syntax: combine (Exp/Eq/Ineq/List/Mat [ ] )

Example: To transform and reduce  $(x + 1)/(x + 2) + x(x + 3)$

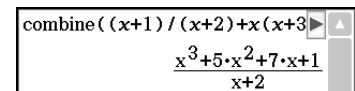

```
combine((x+1)/(x+2)+x(x+3))
(x^3+5*x^2+7*x+1)/(x+2)
```

• **collect** [Action][Transformation][collect]

Function: Rearranges an expression with respect to a specific variable.

Syntax: collect (Exp/Eq/Ineq/List/Mat[,Exp] [ ] )

• “x” is the default when you omit “[,Exp]”.

Example: To rearrange  $x^2 + ax + bx$  with respect to  $x$

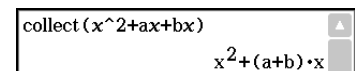

```
collect(x^2+ax+bx)
x^2+(a+b)*x
```

• **tExpand** [Action][Transformation][tExpand]

Function: Employs the sum and difference formulas to expand a trigonometric function.

Syntax: tExpand(Exp/Eq/Ineq/List/Mat [ ] )

Example: To expand  $\sin(a + b)$

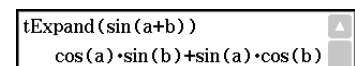

```
tExpand(sin(a+b))
cos(a)*sin(b)+sin(a)*cos(b)
```

• **tCollect** [Action][Transformation][tCollect]

Function: Employs the product to sum formulas to transform the product of a trigonometric function into an expression in the sum form.

Syntax: tCollect (Exp/Eq/Ineq/List/Mat [ ] )

Example: To transform  $\cos(a) \times \cos(b)$  into an expression in the sum form

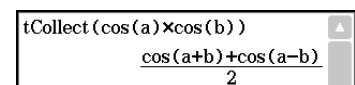

```
tCollect(cos(a)*cos(b))
(cos(a+b)+cos(a-b))/2
```

• **expToTrig** [Action][Transformation][expToTrig]

Function: Transforms an exponent into a trigonometric or hyperbolic function.

Syntax: expToTrig (Exp/Eq/Ineq/List/Mat [ ] )

Example: To transform  $e^{ix}$  into a trigonometric function (Radian mode)

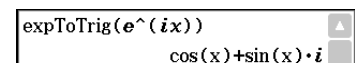

```
expToTrig(e^(i*x))
cos(x)+sin(x)*i
```

• **trigToExp** [Action][Transformation][trigToExp]

Function: Transforms a trigonometric or hyperbolic function into exponential form.

Syntax: trigToExp (Exp/Eq/Ineq/List/Mat [ ] )

Example: To transform  $\cosh x$  into exponential form

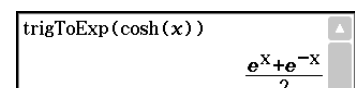

```
trigToExp(cosh(x))
(e^x+e^-x)/2
```

- **toFrac** [Action][Transformation][Fraction][toFrac]

Function: Transforms a decimal value into its equivalent fraction value.

Syntax: toFrac (Exp/Eq/Ineq/List/Mat [ ] )

Example: To transform 5.28 into its equivalent fraction value

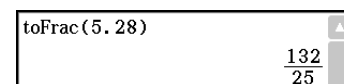

- **propFrac** [Action][Transformation][Fraction][propFrac]

Function: Transforms a decimal value into its equivalent proper fraction value.

Syntax: propFrac (Exp/Eq/Ineq/List/Mat [ ] )

Example: To transform 1.2 into its equivalent proper fraction value

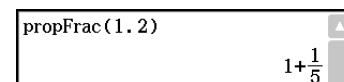

- **dms** [Action][Transformation][DMS][dms]

Function: Transforms a DMS format value into its equivalent degrees-only value.

Syntax: dms (Exp/List-1 [,Exp/List-2][,Exp/List-3] [ ] )

Example: To transform 3° 5' 6" into its equivalent degrees-only value

- Zero is the default when you omit [,Exp/List-2] or [,Exp/List-3][ ] .

**Tip:** You can input 3° 5' 6" using the  key on the soft keyboard.

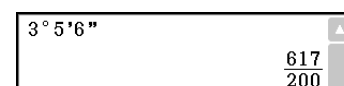
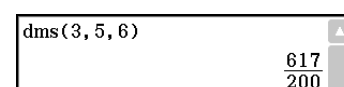

- **toDMS** [Action][Transformation][DMS][toDMS]

Function: Transforms a degrees-only value into its equivalent DMS format value.

Syntax: toDMS (Exp/List [ ] )

Example: To transform 3.085 degrees into its equivalent DMS format value

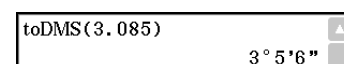

## Using the Advanced Submenu

- **solve** [Action][Advanced][solve]

For information about solve, see page 81.

- **dSolve** [Action][Advanced][dSolve]

For information about dSolve, see page 82.

- **taylor** [Action][Advanced][taylor]

Function: Finds a Taylor polynomial for an expression with respect to a specific variable.

Syntax: taylor (Exp/List, variable, order [,center point] [ ] )

Example: To find a 5th order Taylor polynomial for  $\sin(x)$  with respect to  $x = 0$  (in the Radian mode)

- Zero is the default when you omit “[,center point]”.

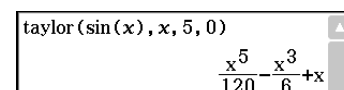

- **laplace** [Action][Advanced][laplace], **invLaplace** [Action][Advanced][invLaplace]

Function: “laplace” is the command for the Laplace transform, and “invLaplace” is the command for the inverse of Laplace transform.

$$L[f(t)](s) = \int_0^{\infty} f(t)e^{-st} dt$$



Syntax:

`laplace(f(t), t, s)`

$f(t)$ : expression ;

$t$ : variable with respect to which the expression is transformed ;

$s$ : parameter of the transform

`invLaplace(L(s), s, t)`

$L(s)$ : expression ;

$s$ : variable with respect to which the expression is transformed ;

$t$ : parameter of the transform

ClassPad supports transform of the following functions.

$\sin(x)$ ,  $\cos(x)$ ,  $\sinh(x)$ ,  $\cosh(x)$ ,  $x^n$ ,  $\sqrt{x}$ ,  $e^x$ ,  $\text{heaviside}(x)$ ,  $\delta(x)$ ,  $\delta(x, n)$

ClassPad does not support transform of the following functions.

$\tan(x)$ ,  $\sin^{-1}(x)$ ,  $\cos^{-1}(x)$ ,  $\tan^{-1}(x)$ ,  $\tanh(x)$ ,  $\sinh^{-1}(x)$ ,  $\cosh^{-1}(x)$ ,  $\tanh^{-1}(x)$ ,  $\log(x)$ ,  $\ln(x)$ ,  $1/x$ ,  $\text{abs}(x)$ ,  $\text{gamma}(x)$

## Laplace Transform of a Differential Equation

The laplace command can be used to solve ordinary differential equations. ClassPad does not support System of Differential Equations for laplace.

Syntax: `laplace(diff eq, x, y, t)`

diff eq: differential equation to solve ;  $x$ : independent variable in the diff eq ;

$y$ : dependent variable in the diff eq ;  $t$ : parameter of the transform

Example: To solve a differential equation  $x' + 2x = e^{-t}$  where  $x(0) = 3$  using the Laplace transform

Lp means  $F(s) = L[f(t)]$  in the result of transform for a differential equation.

```
laplace(x'+2x=e^-t, t, x, s)
-x(0)+Lp*s+2*Lp=1/(s+1)
ans|x(0)=3
Lp*s+2*Lp-3=1/(s+1)
solve(ans, Lp)
{Lp= (3*s+4)/(s^2+3*s+2)}
invLaplace(getRight(ans[1]), s, t)
e^-t+2*e^-2*t
```

## • **fourier** [Action][Advanced][fourier], **invFourier** [Action][Advanced][invFourier]

Function: “fourier” is the command for the Fourier Transform, and “invFourier” is the command for the inverse Fourier Transform.

Syntax: `fourier(f(x), x, w, n)` `invFourier(F(w), w, x, n)`

$x$ : variable with respect to which the expression is transformed with ;  $w$ : parameter of the transform ;

$n$ : 0 to 4, indicating Fourier parameter to use (optional)

ClassPad supports transform of the following functions.

$\sin(t)$ ,  $\cos(t)$ ,  $\log(t)$ ,  $\ln(t)$ ,  $\text{abs}(t)$ ,  $\text{signum}(t)$ ,  $\text{heaviside}(t)$ ,  $\delta(t)$ ,  $\delta(t, n)$ ,  $e^{ti}$

ClassPad does not support transform of the following functions.

$\tan(t)$ ,  $\sin^{-1}(t)$ ,  $\cos^{-1}(t)$ ,  $\tan^{-1}(t)$ ,  $\sinh(t)$ ,  $\cosh(t)$ ,  $\tanh(t)$ ,  $\sinh^{-1}(t)$ ,  $\cosh^{-1}(t)$ ,  $\tanh^{-1}(t)$ ,  $\text{gamma}(t)$ ,  $\sqrt{t}$ ,  $e^t$

The Fourier Transform is defined as the following:

$$F(k) = \int_{-\infty}^{\infty} f(x)e^{-2\pi i k x} dx$$

$$f(x) = \int_{-\infty}^{\infty} F(k)e^{2\pi i k x} dk$$

Some authors (especially physicists) prefer to write the transform in terms of angular frequency  $\omega \equiv 2\pi\nu$  instead of the oscillation frequency  $\nu$ .

However, this destroys the symmetry, resulting in the transform pair shown below.

$$H(\omega) = F[h(t)] = \int_{-\infty}^{\infty} h(t)e^{-i\omega t} dt$$

$$h(t) = F^{-1}[H(\omega)] = \frac{1}{2\pi} \int_{-\infty}^{\infty} H(\omega)e^{i\omega t} d\omega$$

To restore the symmetry of the transforms, the convention shown below is sometimes used.

$$g(y) = F[f(t)] = \frac{1}{\sqrt{2\pi}} \int_{-\infty}^{\infty} f(t)e^{-iyt} dt \quad f(t) = F^{-1}[g(y)] = \frac{1}{\sqrt{2\pi}} \int_{-\infty}^{\infty} g(y)e^{iyt} dy$$

In general, the Fourier transform pair may be defined using two arbitrary constants  $a$  and  $b$  as shown below.

$$F(\omega) = \sqrt{\frac{|b|}{(2\pi)^{1-a}}} \int_{-\infty}^{\infty} f(t)e^{ib\omega t} dt \quad f(t) = \sqrt{\frac{|b|}{(2\pi)^{1+a}}} \int_{-\infty}^{\infty} F(\omega)e^{-ib\omega t} d\omega$$

The values of  $a$  and  $b$  depend on the scientific discipline, which can be specified by the value of  $n$  (optional fourth parameter of `fourier` and `invFourier`) as shown below.

Unfortunately, a number of conventions are in widespread use for  $a$  and  $b$ . For example, (0, 1) is used in modern physics, (1, -1) is used in pure mathematics and systems engineering, (1, 1) is used in probability theory for the computation of the characteristic function, (-1, 1) is used in classical physics, and (0, -2π) is used in signal processing.

Transform Definition	$n$ (optional)	$a$	$b$
Modern Physics	0	0	1
Pure Math	1	1	-1
Probability	2	1	1
Classical Physics	3	-1	1
Signal Processing	4	0	-2π

**Tip:** The Advanced Format dialog box can be used to configure settings related to the Fourier Transform, such as Fourier Transform definition, etc. For details, see “Advanced Format Dialog Box” on page 40.

• **FFT [Action][Advanced][FFT], IFFT [Action][Advanced][IFFT]**

Function: “FFT” is the command for the fast Fourier Transform, and “IFFT” is the command for the inverse fast Fourier Transform.  $2^n$  data values are needed to perform FFT and IFFT. On the ClassPad, FFT and IFFT are calculated numerically.

Syntax: `FFT(list)` or `FFT(list, m)`      `IFFT(list)` or `IFFT(list, m)`

- Data size must be  $2^n$  for  $n = 1, 2, 3, \dots$
- The value for  $m$  is optional. It can be from 0 to 2, indicating the FFT parameter to use: 0 (Signal Processing), 1 (Pure Math), 2 (Data Analysis).

The FTT and IFFT are defined as the following:

$$F(t) = \sum_{x=0}^{N-1} f(x)e^{-i\frac{2\pi tx}{N}} \quad f(x) = \frac{1}{N} \sum_{t=0}^{N-1} F(t)e^{i\frac{2\pi tx}{N}}$$

**Tip:** The Advanced Format dialog box can be used to configure Fast Fourier Transform settings. For details, see “Advanced Format Dialog Box” on page 40.

---

## Using the Calculation Submenu

The [Calculation] submenu contains calculus related commands, such as “diff” (differentiation) and “ $\int$ ” (integration).

### • diff [Action][Calculation][diff]

Function: Differentiates an expression with respect to a specific variable.

Syntax: diff(Exp/List[,variable] [ ] )  
diff(Exp/List,variable,order[,a] [ ] )

- “a” is the point for which you want to determine the derivative.
- “order” = 1 when you use the following syntax: diff(Exp/List[,variable][ ] ). The default variable is “x” when “variable” is omitted.

Example: To differentiate  $x^6$  with respect to  $x$

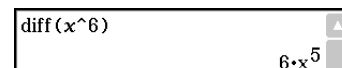

```
diff (x^6)
6*x^5
```

### • impDiff [Action][Calculation][impDiff]

Function: Differentiates an equation or expression in implicit form with respect to a specific variable.

Syntax: impDiff(Eq/Exp/List, independent variable, dependent variable)

Example: To find  $y'$  using implicit differentiation

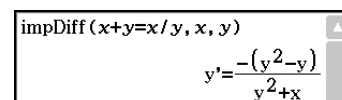

```
impDiff (x+y=x/y, x, y)
y' = -(y^2 - y) / (y^2 + x)
```

### **Important!**

The derivative symbol (') cannot be used in the argument of “impDiff”. Trying to use a derivative symbol would result in a Wrong Argument Type error.

### • $\int$ [Action][Calculation][ $\int$ ]

Function: Integrates an expression with respect to a specific variable.

Syntax:  $\int$ (Exp/List[,variable] [ ] )  
 $\int$ (Exp/List, variable, lower limit, upper limit [,tol] [ ] )

- “x” is the default when you omit [,variable].
- “tol” represents the allowable error range.
- This command returns an approximate value when a range is specified for “tol”.
- This command returns the true value of a definite interval when nothing is specified for “tol”. If a true value cannot be obtained, this command performs approximate calculation using  $tol = 1E - 5$ . If an approximate value can be obtained, that value is returned. An error message is returned if an approximate value cannot be obtained or if the calculation itself is not possible for some reason.

Example: To integrate  $x$  with respect to  $x$

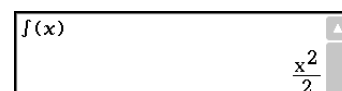

```
f(x)
x^2 / 2
```

### • lim [Action][Calculation][lim]

Function: Determines the limit of an expression.

Syntax: lim (Exp/List, variable, point [,direction] [ ] )

Example: To determine the limit of  $e^{-x}$  as  $x$  approaches  $\infty$

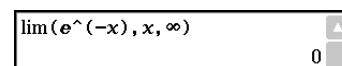

```
lim (e^(-x), x, infinity)
0
```

- This function returns the limit from the left when “direction” < 0, the limit from the right when “direction” > 0, and the limit from both sides (left and right) when “direction” = 0 or when the direction is omitted.

•  **$\Sigma$**  [Action][Calculation][ $\Sigma$ ]

Function: Evaluates an expression at discrete variable values within a range, and then calculates a sum.

Syntax:  $\Sigma(\text{Exp/List}, \text{variable}, \text{lower value}, \text{upper value} [ ] )$

Example: To calculate the sum of  $x^2$  as the value of  $x$  changes from  $x = 1$  through  $x = 10$

$\Sigma(x^2, x, 1, 10)$   
385

•  **$\Pi$**  [Action][Calculation][ $\Pi$ ]

Function: Evaluates an expression at discrete variable values within a range, and then calculates a product.

Syntax:  $\Pi(\text{Exp/List}, \text{variable}, \text{lower value}, \text{upper value} [ ] )$

Example: To calculate the product of  $x^2$  as the value of  $x$  changes from  $x = 1$  through  $x = 5$

$\Pi(x^2, x, 1, 5)$   
14400

• **rangeAppoint** [Action][Calculation][rangeAppoint]

Function: Finds an expression or value that satisfies a condition in a specified range.

Syntax: rangeAppoint (Exp/Eq/List, start value, end value [ ] )

- When using an equation (Eq) for the first argument, input the equation using the syntax Var = Exp. Evaluation will not be possible if any other syntax is used.

Example: To find the expression(s) in the list  $\{x = \pi, x = 2\pi, x = 3\pi\}$  that belong(s) to the closed range  $0 \leq x \leq 5$

rangeAppoint ( {x= $\pi$ , x=2 $\times$  $\pi$ , x=3 $\times$  $\pi$  }, 0, 5)  
{x= $\pi$ }

• **mod** [Action][Calculation][mod]

Function: Returns the remainder when one expression is divided by another expression.

Syntax: mod ({Exp/List} -1, {Exp/List} -2 [ ] )

Example: To determine the remainder when 26 is divided by 3 (26mod3)

mod (26, 3)  
2

• **tanLine** [Action][Calculation][line][tanLine]

Function: Returns the right side of the equation for the tangent line ( $y = \text{'expression'}$ ) to the curve at the specified point.

Syntax: tanLine (Exp/List, variable, variable value at point of tangency [ ] )

Example: To determine the function of the line tangent to  $y = x^3$  at  $x = 2$

tanLine (x^3, x, 2)  
12 $\cdot$ x-16

• **normal** [Action][Calculation][line][normal]

Function: Returns the right side of the equation for the line normal ( $y = \text{'expression'}$ ) to the curve at the specified point.

Syntax: normal (Exp/List, variable, variable value at point of normal [ ] )

Example: To determine the function of the line normal to  $y = x^3$  at  $x = 2$

normal (x^3, x, 2)  
 $-\frac{x}{12} + \frac{49}{6}$

• **arcLen** [Action][Calculation][line][arcLen]

Function: Returns the arc length of an expression from a start value to an end value with respect to a specified variable.

Syntax: arcLen (Exp/List, variable, start value, end value [ ] )

Example: To determine the arc length for  $y = x^{\frac{3}{2}}$  from  $x = 0$  to  $x = 4$

arcLen (x^(3/2), x, 0, 4)  
 $\frac{80\sqrt{10}}{27} - \frac{8}{27}$

• **fMin** [Action][Calculation][fMin/fMax][fMin], **fMax** [Action][Calculation][fMin/fMax][fMax]

Function: Returns the minimum (fMin) / the maximum (fMax) point in a specific range of a function.

Syntax: fMin(Exp[,variable] [ ] )

fMin(Exp, variable, start value, end value[,n] [ ] )

fMax(Exp[,variable] [ ] )

fMax(Exp, variable, start value, end value[,n] [ ] )

- “x” is the default when you omit “[,variable]”.
- Negative infinity and positive infinity are the default when the syntax fMin(Exp[,variable] [ ] ) or fMax(Exp[,variable] [ ] ) is used.
- “n” is calculation precision, which you can specify as an integer in the range of 1 to 9. Using any value outside this range causes an error.
- This command returns an approximate value when calculation precision is specified for “n”.
- This command returns a true value when nothing is specified for “n”. If the true value cannot be obtained, however, this command returns an approximate value along with  $n = 4$ .
- Discontinuous points or sections that fluctuate widely can adversely affect precision or even cause an error.
- Inputting a larger number for “n” increases the precision of the calculation, but it also increases the amount of time required to perform the calculation.
- The value you input for the end point of the interval must be greater than the value you input for the start point. Otherwise an error occurs.

Example: To find the minimum point of  $x^2 - 1$  with respect to  $x$

```
fMin(x^2-1, x)
{MinValue=-1, x=0}
```

Example: To find the maximum point of  $-x^2 + 1$  with respect to  $x$

```
fMax(-x^2+1, x)
{MaxValue=1, x=0}
```

• **gcd** [Action][Calculation][gcd/lcm][gcd]

Function: Returns the greatest common denominator of two expressions.

Syntax: gcd (Exp/List-1, Exp/List-2 [ ] )

Example: To obtain the greatest common denominator of  $x + 1$  and  $x^2 - 3x - 4$

```
gcd(x+1, x^2-3*x-4)
x+1
```

• **lcm** [Action][Calculation][gcd/lcm][lcm]

Function: Returns the least common multiple of two expressions.

Syntax: lcm (Exp/List-1, Exp/List-2 [ ] )

Example: To obtain the least common multiple of  $x^2 - 1$  and  $x^2 + 2x - 3$

```
lcm(x^2-1, x^2+2*x-3)
(x^2+2*x-3)*(x+1)
```

• **denominator** [Action][Calculation][fraction][denominator]

Function: Extracts the denominator of a fraction.

Syntax: denominator (Exp/List [ ] )

Example: To extract the denominator of the fraction  $(y - 2)/(x + 1)$

```
denominator((y-2)/(x+1))
x+1
```

• **numerator** [Action][Calculation][fraction][numerator]

Function: Extracts the numerator of a fraction.

Syntax: numerator (Exp/List [ ] )

Example: To extract the numerator of the fraction  $(y - 2)/(x + 1)$

```
numerator((y-2)/(x+1))
y-2
```

## Using the Complex Submenu

The [Complex] submenu contains commands that relate to calculations that involve complex numbers.

- **arg** [Action][Complex][arg]

Function: Returns the argument of a complex number.

Syntax: arg (Exp/Eq/List/Mat [ ] )

Example: To obtain the argument of complex  $2 + i$  (in the Radian mode)

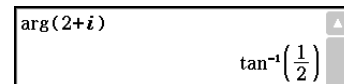

- **conjg** [Action][Complex][conjg]

Function: Returns the conjugate complex number.

Syntax: conjg (Exp/Eq/Ineq≠/List/Mat [ ] ) (Ineq≠: Real mode only)

Example: To obtain the conjugate of complex number  $1 + i$

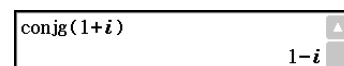

- **re** [Action][Complex][re]

Function: Returns the real part of a complex number.

Syntax: re (Exp/Eq/Ineq≠/List/Mat [ ] ) (Ineq≠: Real mode only)

Example: To obtain the real part of complex number  $3 - 4i$

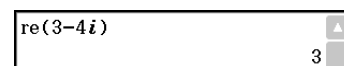

- **im** [Action][Complex][im]

Function: Returns the imaginary part of a complex number.

Syntax: im (Exp/Eq/Ineq≠/List/Mat [ ] ) (Ineq≠: Real mode only)

Example: To obtain the imaginary part of complex number  $3 - 4i$

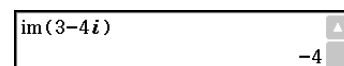

- **cExpand** [Action][Complex][cExpand]

Function: Expands a complex expression to rectangular form ( $a + bi$ ).

Syntax: cExpand (Exp/Eq/List/Mat [ ] )

- The variables are regarded as real numbers.

Example: To expand  $\cos^{-1}(2)$  (in the Radian mode)

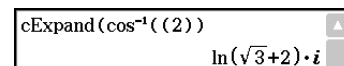

- **compToPol** [Action][Complex][compToPol]

Function: Transforms a complex number into its polar form.

Syntax: compToPol (Exp/Eq/List/Mat [ ] )

- When the argument is Mat (Matrices), calculation can be performed using the Radian angle unit only.

Example: To transform  $1 + i$  into its polar form

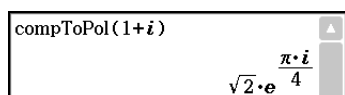

Radian mode

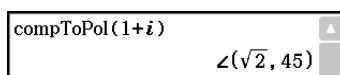

Degree mode

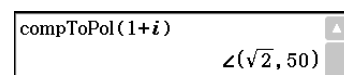

Grad mode

- **compToTrig** [Action][Complex][compToTrig]

Function: Transforms a complex number into its trigonometric/hyperbolic form.

Syntax: compToTrig (Exp/Eq/List/Mat [ ] )

Example: To transform  $1 + i$  into its trigonometric form (in the Radian mode)

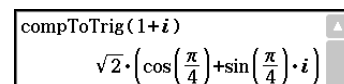

• **compToRect** [Action][Complex][compToRect]

Function: Transforms a complex number into its rectangular form.

Syntax: compToRect ( $\angle(r, \theta)$  or  $r \cdot e^{(\theta \cdot i)}$  form [ ] )

Example: To transform a complex number into its rectangular form

```
compToRect( $\sqrt{2} \cdot e^{\frac{\pi \cdot i}{4}}$ )  
1+i
```

```
compToRect( $\angle(\sqrt{2}, \frac{\pi}{4})$ )  
1+i
```

## Using the List-Create Submenu

The [List][Create] submenu contains commands that are related to creating lists.

• **seq** [Action][List][Create][seq]

Function: Generates a list in accordance with a numeric sequence expression.

Syntax: seq (Exp, variable, start value, end value [,step size] [ ] )

Example: To generate a list in accordance with the expression  $x^2 + 2x$  when the start value is 1, the end value is 5, and the step size is 2

```
seq( $x^2+2x$ , x, 1, 5, 2)  
{3, 15, 35}
```

- “1” is the default when you omit “[,step size]”.
- The step size must be a factor of the difference between the start value and the end value.

• **augment** [Action][List][Create][augment]

Function: Creates a new list by appending one list to another.

Syntax: augment (List-1, List-2 [ ] )

Example: To combine list {1, 2} and list {3, 4}

```
augment({1, 2}, {3, 4})  
{1, 2, 3, 4}
```

• **fill** [Action][List][Create][fill]

Function: Replaces the elements of a list with a specified value or expression. This command can also be used to create a new list whose elements all contain the same value or expression, or a new list in which the frequency of each element in the first list is determined by the corresponding element in the second list.

Syntax: fill (Exp/Eq/Ineq, number of elements [ ] )

fill (Exp/Eq/Ineq, List [ ] )

fill (List, List [ ] )

Example: To create a list consisting of four identical elements (2)

```
fill(2, 4)  
{2, 2, 2, 2}
```

• **subList** [Action][List][Create][subList]

Function: Extracts a specific section of a list into a new list.

Syntax: subList (List [,start number] [,end number] [ ] )

Example: To extract the second through the fourth elements of the list {1, 2, 3, 4, 5}

```
subList({1, 2, 3, 4, 5}, 2, 4)  
{2, 3, 4}
```

- The leftmost element is the default when you omit “[,start number]”, and the rightmost element is the default when you omit “[,end number]”.

• **shift** [Action][List][Create][shift]

Function: Returns a list in which elements have been shifted to the right or left by a specific amount.

Syntax: shift (List [,number of shifts] [ ] )

- Specifying a negative value for “[,number of shifts]” shifts to the right, while a positive value shifts to the left.
- Right shift by one (-1) is the default when you omit “[,number of shifts]”.

Example: To shift the elements of the list {1, 2, 3, 4, 5, 6} to the left by three

```
shift({1, 2, 3, 4, 5, 6}, 3)  
{4, 5, 6, Undefined, Undefined, }
```

• **rotate** [Action][List][Create][rotate]

Function: Returns a list in which the elements have been rotated to the right or to the left by a specific amount.

Syntax: rotate (List [,number of rotations] [ ] )

- Specifying a negative value for “[,number of rotations]” rotates to the right, while a positive value rotates to the left.

Example: To rotate the elements of the list {1, 2, 3, 4, 5, 6} to the left by two

```
rotate({1, 2, 3, 4, 5, 6}, 2)
{3, 4, 5, 6, 1, 2}
```

- Right rotation by one (-1) is the default when you omit “[,number of rotations]”.

• **sortA** [Action][List][Create][sortA]

Function: Sorts the elements of the list into ascending order.

Syntax: sortA (List [ ] )

Example: To sort the elements of the list {1, 5, 3} into ascending order

```
sortA({1, 5, 3})
{1, 3, 5}
```

• **sortD** [Action][List][Create][sortD]

Function: Sorts the elements of the list into descending order.

Syntax: sortD (List [ ] )

Example: To sort the elements of the list {1, 5, 3} into descending order

```
sortD({1, 5, 3})
{5, 3, 1}
```

• **listToMat** [Action][List][Create][listToMat]

Function: Transforms lists into a matrix.

Syntax: listToMat (List-1 [, List-2, ..., List-N] [ ] )

Example: To transform the lists {3, 5} and {2, 4} into a matrix

```
listToMat({3, 5}, {2, 4})
[ 3 2 ]
[ 5 4 ]
```

• **matToList** [Action][List][Create][matToList]

- For information about matToList, see page 76.

---

## Using the List-Statistics and List-Calculation Submenus

The [List][Statistics] and [List][Calculation] submenus contain commands related to list calculations.

• **min** [Action][List][Statistics][min]

Function: Returns the minimum value of an expression or the elements in a list.

Syntax: min (Exp/List-1[, Exp/List-2] [ ] )

Example: To determine the minimum values of the elements in list {1, 2, 3}

```
min({1, 2, 3})
1
```

• **max** [Action][List][Statistics][max]

Function: Returns the maximum value of an expression or the elements of a list.

Syntax: max (Exp/List-1[, Exp/List-2] [ ] )

Example: To determine the maximum value of the elements in list {1, 2, 3}

```
max({1, 2, 3})
3
```

• **mean** [Action][List][Statistics][mean]

Function: Returns the mean of the elements in a list.

Syntax: mean (List-1[, List-2] [ ] ) (List-1: Data, List-2: Freq)

Example: To determine the mean of the elements in list {1, 2, 3}

```
mean({1, 2, 3})
2
```



• **median** [Action][List][Statistics][median]

Function: Returns the median of the elements in a list.

Syntax: median (List-1[, List-2] [ ] ) (List-1: Data, List-2: Freq)

Example: To determine the median of the elements in the list {1, 2, 3}

```
median({1, 2, 3})  
2
```

• **mode** [Action][List][Statistics][mode]

Function: Returns the mode of the elements in a list. If there are multiple modes, they are returned in a list.

Syntax: mode (List-1[, List-2] [ ] ) (List-1: Data, List-2: Freq)

Example: To determine the mode of the elements in the list {1, 1, 2, 2, 2}

```
mode({1, 1, 2, 2, 2})  
2
```

• **Q<sub>1</sub>** [Action][List][Statistics][Q<sub>1</sub>]

Function: Returns the first quartile of the elements in a list.

Syntax: Q<sub>1</sub> (List-1[, List-2] [ ] ) (List-1: Data, List-2: Freq)

Example: To determine the first quartile of the elements in the list {1, 2, 3, 4, 5}

```
Q1({1, 2, 3, 4, 5})  
 $\frac{3}{2}$ 
```

• **Q<sub>3</sub>** [Action][List][Statistics][Q<sub>3</sub>]

Function: Returns the third quartile of the elements in a list.

Syntax: Q<sub>3</sub> (List-1[, List-2] [ ] ) (List-1: Data, List-2: Freq)

Example: To determine the third quartile of the elements in the list {1, 2, 3, 4, 5}

```
Q3({1, 2, 3, 4, 5})  
 $\frac{9}{2}$ 
```

• **percentile** [Action][List][Statistics][percentile]

Function: Finds the *n*th percentile point in a list.

Syntax: percentile (List, number)

```
percentile({1, 2, 3, 4}, 70)  
 $\frac{31}{10}$ 
```

• **stdDev** [Action][List][Statistics][stdDev]

Function: Returns the sample standard deviation of the elements in a list.

Syntax: stdDev (List [ ] )

Example: To determine the sample standard deviation of the elements in the list {1, 2, 4}

```
stdDev({1, 2, 4})  
 $\frac{\sqrt{21}}{3}$ 
```

• **variance** [Action][List][Statistics][variance]

Function: Returns the sample variance of the elements in a list.

Syntax: variance (List [ ] )

Example: To determine the sample variance of the elements in the list {1, 2, 4}

```
variance({1, 2, 4})  
 $\frac{7}{3}$ 
```

• **dim** [Action][List][Calculation][dim]

Function: Returns the dimension of a list.

Syntax: dim (List [ ] )

Example: To determine the dimension of the list {1, 2, 3}

```
dim({1, 2, 3})  
3
```

• **sum** [Action][List][Calculation][sum]

Function: Returns the sum of the elements in a list.

Syntax: sum (List-1[, List-2] [ ] ) (List-1: Data, List-2: Freq)

Example: To determine the sum of the elements in the list {1, 2, 3}

```
sum({1, 2, 3})  
6
```

• **prod** [Action][List][Calculation][prod]

Function: Returns the product of the elements in a list.

Syntax: prod (List-1[, List-2] [ ] ) (List-1: Data, List-2: Freq)

Example: To determine the product of the elements in the list {1, 2, 3}

```
prod({1, 2, 3})  
6
```

• **cuml** [Action][List][Calculation][cuml]

Function: Returns the cumulative sums of the elements in a list.

Syntax: cuml (List [ ] )

Example: To determine the cumulative sums of the elements in the list {1, 2, 3}

```
cuml({1, 2, 3})  
{1, 3, 6}
```

• **Δlist** [Action][List][Calculation][Δlist]

Function: Returns a list whose elements are the differences between two adjacent elements in another list.

Syntax: Δlist (List [ ] )

Example: To generate a list whose elements are the differences between two adjacent elements in the list {1, 2, 4}

```
Δlist({1, 2, 4})  
{1, 2}
```

• **percent** [Action][List][Calculation][percent]

Function: Returns the percentage of each element in a list, the sum of which is assumed to be 100.

Syntax: percent (List [ ] )

Example: To determine the percentage of each element in the list {1, 2, 3}

```
percent({1, 2, 3})  
{ $\frac{50}{3}$ ,  $\frac{100}{3}$ , 50}
```

• **polyEval** [Action][List][Calculation][polyEval]

Function: Returns a polynomial arranged in the descending order of powers, so coefficients correspond sequentially to each element in the input list.

Syntax: polyEval (List [,Exp/List] [ ] )

• “x” is the default when you omit “[,Exp/List]”.

Example: To create a second degree polynomial with the coefficients {1, 2, 3}

```
polyEval({1, 2, 3})  
 $x^2+2x+3$ 
```

• **sequence** [Action][List][Calculation][sequence]

Function: Returns the lowest-degree polynomial that represents the sequence expressed by the input list.

When there are two lists, this command returns a polynomial that maps each element in the first list to its corresponding element in the second list.

Syntax: sequence (List-1[, List-2] [,variable] [ ] )

• “x” is the default when you omit “[,variable]”.

Example: To determine a polynomial for a sequence expressed by the list {3, 5, 7, 9}

```
sequence({3, 5, 7, 9})  
 $2x+1$ 
```

• **sumSeq** [Action][List][Calculation][sumSeq]

Function: Finds the lowest-degree polynomial that represents the sequence expressed by the input list and returns the sum of the polynomial. When there are two lists, this command returns a polynomial that maps each element in the first list to its corresponding element in the second list, and returns the sum of the polynomial.

Syntax: `sumSeq (List-1[, List-2] [,variable] [ ] )`

- “x” is the default when you omit “[,variable]”.

Example: To determine the sum of a polynomial for a sequence expressed by the list {3, 5, 7, 9}

```
sumSeq({3, 5, 7, 9})  
x2+2·x
```

---

## Using the Matrix-Create Submenu

The [Matrix][Create] submenu contains commands related to creation of matrices.

- **trn** [Action][Matrix][Create][trn]

Function: Returns a transposed matrix.

Syntax: `trn (Mat [ ] )`

Example: To transpose the matrix  $\begin{bmatrix} 1 & 2 \\ 3 & 4 \end{bmatrix}$

```
trn([[1, 2][3, 4]])  
 $\begin{bmatrix} 1 & 3 \\ 2 & 4 \end{bmatrix}$ 
```

- **augment** [Action][Matrix][Create][augment]

Function: Returns a matrix that combines two other matrices.

Syntax: `augment (Mat-1, Mat-2 [ ] )`

Example: To combine the two matrices  $\begin{bmatrix} 1 & 2 \\ 3 & 4 \end{bmatrix}$  and  $\begin{bmatrix} 5 & 6 \\ 7 & 8 \end{bmatrix}$

```
augment([[1, 2][3, 4]], [[5, 6][7, 8]])  
 $\begin{bmatrix} 1 & 2 & 5 & 6 \\ 3 & 4 & 7 & 8 \end{bmatrix}$ 
```

- **ident** [Action][Matrix][Create][ident]

Function: Creates an identity matrix.

Syntax: `ident (natural number [ ] )`

Example: To create a  $2 \times 2$  identity matrix

```
ident(2)  
 $\begin{bmatrix} 1 & 0 \\ 0 & 1 \end{bmatrix}$ 
```

- **fill** [Action][Matrix][Create][fill]

Function: Creates a matrix with a specific number of rows and columns, or replaces the elements of a matrix with a specific expression.

Syntax: `fill (Exp, number of rows, number of columns [ ] )`  
`fill (Exp, Mat [ ] )`

Example: To create a  $2 \times 3$  matrix, all whose elements are 2

```
fill(2, 2, 3)  
 $\begin{bmatrix} 2 & 2 & 2 \\ 2 & 2 & 2 \end{bmatrix}$ 
```

- **subMat** [Action][Matrix][Create][subMat]

Function: Extracts a specific section of a matrix into a new matrix.

Syntax: `subMat (Mat [,start row] [,start column] [,end row] [,end column] [ ] )`

- “1” is the default when you omit “[, start row]” and “[, start column]”.
- The last row number is the default when you omit “[, end row]”.
- The last column number is the default when you omit “[, end column]”.

Example: To extract the section from row 2, column 2, to row 3, column 3 from the matrix  $\begin{bmatrix} 1 & 4 & 7 \\ 2 & 5 & 8 \\ 3 & 6 & 9 \end{bmatrix}$

```
◀4, 7][2, 5, 8][3, 6, 9]→Mat1  
 $\begin{bmatrix} 1 & 4 & 7 \\ 2 & 5 & 8 \\ 3 & 6 & 9 \end{bmatrix}$   
subMat(Mat1, 2, 2, 3, 3)  
 $\begin{bmatrix} 5 & 8 \\ 6 & 9 \end{bmatrix}$ 
```

- **diag** [Action][Matrix][Create][diag]

Function: Returns a one-row matrix containing the elements from the main diagonal of a square matrix.

Syntax: `diag (Mat[ ] )`

Example: To extract the diagonal elements of the matrix  $\begin{bmatrix} 1 & 2 \\ 3 & 4 \end{bmatrix}$

```
diag([[1, 2][3, 4]])  
[1 4]
```

- **listToMat** [Action][Matrix][Create][listToMat]

- For information about listToMat, see page 72.

- **matToList** [Action][Matrix][Create][matToList]

Function: Transforms a specific column of a matrix into a list.

Syntax: matToList (Mat, column number [ ] )

Example: To transform column 2 of the matrix  $\begin{bmatrix} 1 & 2 \\ 3 & 4 \end{bmatrix}$  into a list

```
matToList([[1, 2][3, 4]], 2)
{2, 4}
```

## Using the Matrix-Calculation and Matrix-Row&Column Submenus

The [Matrix][Calculation] and [Matrix][Row&Column] submenus contain commands that are related to matrix calculations.

- **dim** [Action][Matrix][Calculation][dim]

Function: Returns the dimensions of a matrix as a two-element list {number of rows, number of columns}.

Syntax: dim (Mat [ ] )

Example: To determine the dimensions of the matrix  $\begin{bmatrix} 1 & 2 & 3 \\ 4 & 5 & 6 \end{bmatrix}$

```
dim([[1, 2, 3][4, 5, 6]])
{2, 3}
```

- **det** [Action][Matrix][Calculation][det]

Function: Returns the determinant of a square matrix.

Syntax: det (Mat [ ] )

Example: To obtain the determinant of the matrix  $\begin{bmatrix} 1 & 2 \\ 4 & 5 \end{bmatrix}$

```
det([[1, 2][4, 5]])
-3
```

- **norm** [Action][Matrix][Calculation][norm]

Function: Returns the Frobenius norm of the matrix.

Syntax: norm (Mat [ ] )

Example: To determine the norm of the matrix  $\begin{bmatrix} 1 & 2 \\ 4 & 5 \end{bmatrix}$

```
norm([[1, 2][4, 5]])
√46
```

- **rank** [Action][Matrix][Calculation][rank]

Function: Finds the rank of matrix.

The rank function computes the rank of a matrix by performing Gaussian elimination on the rows of the given matrix. The rank of matrix A is the number of non-zero rows in the resulting matrix.

Syntax: rank (Mat [ ] )

```
rank(
  [ 1 2 3 ]
  [ 3 4 5 ]
  [ 2 4 6 ]
)
2
```

- **ref** [Action][Matrix][Calculation][ref]

Function: Returns the row echelon form of a matrix.

Syntax: ref (Mat [ ] )

Example: To obtain the row echelon form of the matrix  $\begin{bmatrix} 1 & 2 & 3 \\ 4 & 5 & 6 \end{bmatrix}$

```
ref([[1, 2, 3][4, 5, 6]])
[ 1 2 3 ]
[ 0 1 2 ]
```

- **rref** [Action][Matrix][Calculation][rref]

Function: Returns the reduced row echelon form of a matrix.

Syntax: rref (Mat [ ] )

Example: To obtain the reduced row echelon form of the matrix  $\begin{bmatrix} 2 & -1 & 3 & 19 \\ 1 & 1 & -5 & -21 \\ 0 & 4 & 3 & 0 \end{bmatrix}$

```
rref([[2, -1, 3, 19][1, 1, -5, -21][0, 4, 3, 0]])
[ 1 0 0 2 ]
[ 0 1 0 -3 ]
[ 0 0 1 4 ]
```

• **eigVI** [Action][Matrix][Calculation][eigVI]

Function: Returns a list that contains the eigenvalue(s) of a square matrix.

Syntax: eigVI (Mat [ ] )

Example: To obtain the eigenvalue(s) of the matrix  $\begin{bmatrix} 3 & 4 \\ 1 & 3 \end{bmatrix}$

```
eigVI([[3, 4][1, 3]])
{5, 1}
```

• **eigVc** [Action][Matrix][Calculation][eigVc]

Function: Returns a matrix in which each column represents an eigenvector of a square matrix.

- Since an eigenvector usually cannot be determined uniquely, it is standardized as follows to its norm, which is 1:

$$\text{When } V = [x_1, x_2, \dots, x_n], \sqrt{(|x_1|^2 + |x_2|^2 + \dots + |x_n|^2)} = 1.$$

Syntax: eigVc (Mat [ ] )

Example: To obtain the eigenvector(s) of the matrix  $\begin{bmatrix} 3 & 4 \\ 1 & 3 \end{bmatrix}$

```
eigVc([[3, 4][1, 3]])
[0.894427191 -0.8944271
0.4472135955 0.44721359]
```

• **LU** [Action][Matrix][Calculation][LU]

Function: Returns the LU decomposition of a square matrix.

Syntax: LU (Mat, lVariableMem, uVariableMem [ ] )

Example: To obtain the LU decomposition of the matrix  $\begin{bmatrix} 1 & 2 & 3 \\ 4 & 5 & 6 \\ 7 & 8 & 9 \end{bmatrix}$

- The lower matrix is assigned to the first variable L, while the upper matrix is assigned to the second variable U.

```
LU([[1, 2, 3][4, 5, 6][7, 8, 9]], L, U)
done
```

To display the lower matrix

L  EXE

```
L
[1 0 0
4 1 0
7 2 1]
```

To display the upper matrix

U  EXE

```
U
[1 2 3
0 -3 -6
0 0 0]
```

• **QR** [Action][Matrix][Calculation][QR]

Function: Returns the QR decomposition of a square matrix.

Syntax: QR (Mat, qVariableMem, rVariableMem [ ] )

Example: To obtain the QR decomposition of the matrix  $\begin{bmatrix} 1 & 2 \\ 3 & 4 \end{bmatrix}$

- The unitary matrix is assigned to variable Q, while the upper triangular matrix is assigned to variable R.

```
QR([[1, 2][3, 4]], Q, R)
done
```

To display the unitary matrix

Q  EXE

```
Q
[ sqrt(10)/10 3*sqrt(10)/10
3*sqrt(10)/10 -sqrt(10)/10 ]
```

To display the upper triangular matrix

R  EXE

```
R
[ sqrt(10) 7*sqrt(10)/5
0 sqrt(10)/5 ]
```

• **swap** [Action][Matrix][Row&Column][swap]

Function: Swaps two rows of a matrix.

Syntax: swap (Mat, row number-1, row number-2 [ ] )

Example: To swap row 1 with row 2 of the matrix  $\begin{bmatrix} 1 & 2 \\ 3 & 4 \end{bmatrix}$

```
swap([[1, 2][3, 4]], 2, 1)
[3 4
1 2]
```

• **mRow** [Action][Matrix][Row&Column][mRow]

Function: Multiplies the elements of a specific row in a matrix by a specific expression.

Syntax: mRow (Exp, Mat, row number [ ] )

Example: To multiply row 1 of the matrix  $\begin{bmatrix} 1 & 2 \\ 3 & 4 \end{bmatrix}$  by  $x$

```
mRow(x, [[1, 2][3, 4]], 1)
      [ x  2*x ]
      [ 3  4  ]
```

• **mRowAdd** [Action][Matrix][Row&Column][mRowAdd]

Function: Multiplies the elements of a specific row in a matrix by a specific expression, and then adds the result to another row.

Syntax: mRowAdd (Exp, Mat, row number-1, row number-2 [ ] )

Example: To multiply row 1 of the matrix  $\begin{bmatrix} 1 & 2 \\ 3 & 4 \end{bmatrix}$  by  $x$ , and then add the result to row 2

```
mRowAdd(x, [[1, 2][3, 4]], 1, 2)
      [ 1  2 ]
      [ x+3  2*x+4 ]
```

• **rowAdd** [Action][Matrix][Row&Column][rowAdd]

Function: Adds a specific matrix row to another row.

Syntax: rowAdd (Mat, row number-1, row number-2 [ ] )

Example: To add row 1 of the matrix  $\begin{bmatrix} 1 & 2 \\ 3 & 4 \end{bmatrix}$  to row 2

```
rowAdd([[1, 2][3, 4]], 1, 2)
      [ 1  2 ]
      [ 4  6 ]
```

• **rowDim** [Action][Matrix][Row&Column][rowDim]

Function: Returns the number in rows in a matrix.

Syntax: rowDim (Mat [ ] )

Example: To obtain the number of rows in the matrix  $\begin{bmatrix} 1 & 2 & 3 \\ 4 & 5 & 6 \end{bmatrix}$

```
rowDim([[1, 2, 3][4, 5, 6]])
      2
```

• **rowNorm** [Action][Matrix][Row&Column][rowNorm]

Function: Calculates the sums of the absolute values of the elements of each row of a matrix, and returns the maximum value of the sums.

Syntax: rowNorm (Mat [ ] )

Example: To calculate the sums of the absolute values of the elements in each row of the matrix  $\begin{bmatrix} 1 & -2 & 3 \\ 4 & -5 & -6 \end{bmatrix}$ , and obtain the maximum value of the sums

```
rowNorm([[1, -2, 3][4, -5, -6]])
      15
```

• **colDim** [Action][Matrix][Row&Column][colDim]

Function: Returns the number of columns in a matrix.

Syntax: colDim (Mat [ ] )

Example: To obtain the number of columns in the matrix  $\begin{bmatrix} 1 & 2 \\ 3 & 4 \\ 5 & 6 \end{bmatrix}$

```
colDim([[1, 2][3, 4][5, 6]])
      2
```

• **colNorm** [Action][Matrix][Row&Column][colNorm]

Function: Calculates the sums of the absolute values of the elements of each column of a matrix, and returns the maximum value of the sums.

Syntax: colNorm (Mat [ ] )

Example: To calculate the sums of the absolute values of the elements in each column of the matrix  $\begin{bmatrix} 1 & -2 & 3 \\ 4 & -5 & -6 \\ -7 & 8 & 9 \end{bmatrix}$ , and obtain the maximum value of the sums

```
colNorm([[1, -2, 3][4, -5, -6][-7, 8, 9]])
      18
```

---

## Using the Vector Submenu

The [Vector] submenu contains commands that are related to vector calculations.

- A vector is handled as a  $1 \times N$  matrix or  $N \times 1$  matrix.
- A vector in the form of  $1 \times N$  can be entered as [.....] or [[.....]].

Example: [1, 2], [[1, 2]]

- Vectors are considered to be in rectangular form unless  $\angle()$  is used to indicate an angle measure.

### • **augment** [Action][Vector][augment]

Function: Returns an augmented vector [Mat-1 Mat-2].

Syntax: augment (Mat-1, Mat-2 [ ] )

Example: To augment vectors [1, 2] and [3, 4]

```
augment([1, 2], [3, 4])  
[1 2 3 4]
```

### • **fill** [Action][Vector][fill]

Function: Creates a vector that contains a specific number of elements, or replaces the elements of a vector with a specific expression.

Syntax: fill (Exp, Mat [ ] )

fill (Exp, 1, number of columns [ ] )

Example: To replace the elements of the vector [1, 2] with  $x$

```
fill(x, [1, 2])  
[x x]
```

Example: To create a  $1 \times 3$  (1 row, 3 columns) vector, all of whose elements are "3"

```
fill(3, 1, 3)  
[3 3 3]
```

### • **dim** [Action][Vector][dim]

Function: Returns the dimension of a vector.

Syntax: dim (Mat [ ] )

Example: To determine the dimension of the vector [1, 2, 3]

- The vector [1, 2, 3] is handled as a  $1 \times 3$  matrix.

```
dim([1, 2, 3])  
{1, 3}
```

### • **unitV** [Action][Vector][unitV]

Function: Normalizes a vector.

Syntax: unitV (Mat [ ] )

- This command can be used with a  $1 \times N$  or  $N \times 1$  matrix only.

Example: To normalize the vector [1, 3, 5]

```
unitV([1, 3, 5])  
[ $\frac{\sqrt{35}}{35}$   $\frac{3 \cdot \sqrt{35}}{35}$   $\frac{\sqrt{35}}{7}$ ]
```

### • **angle** [Action][Vector][angle]

Function: Returns the angle formed by two vectors.

Syntax: angle (Mat-1, Mat-2 [ ] )

- This command can be used with a  $1 \times N$  or  $N \times 1$  matrix only.

Example: To determine the angle formed by vectors [1, 2] and [3, 4] (in the Radian mode)

```
angle([1, 2], [3, 4])  
 $\cos^{-1}\left(\frac{11 \cdot \sqrt{5}}{25}\right)$ 
```

• **norm** [Action][Vector][norm]

Function: Returns the norm of a vector.

Syntax: norm (Mat [ ] )

Example: To obtain the norm of the vector [1, 2, 3]

```
norm([1, 2, 3])
√14
```

• **crossP** [Action][Vector][crossP]

Function: Returns the cross product of two vectors.

Syntax: crossP (Mat-1, Mat-2 [ ] )

- This command can be used with a  $1 \times N$  or  $N \times 1$  matrix only ( $N = 2, 3$ ).
- A two-element matrix [a, b] or [[a], [b]] is automatically converted into a three-element matrix [a, b, 0] or [[a], [b], [0]].

Example: To obtain the cross product of the two vectors [1, 3, 5] and [2, 4, 6]

```
crossP([1, 3, 5], [2, 4, 6])
[-2 4 -2]
```

• **dotP** [Action][Vector][dotP]

Function: Returns the dot product of two vectors.

Syntax: dotP (Mat-1, Mat-2 [ ] )

- This command can be used with a  $1 \times N$  or  $N \times 1$  matrix only.

Example: To obtain the dot product of the two vectors [1, 3, 5] and [2, 4, 6]

```
dotP([1, 3, 5], [2, 4, 6])
44
```

• **toRect** [Action][Vector][toRect]

Function: Returns an equivalent rectangular form [x y] or [x y z].

Syntax: toRect (Mat [,natural number] [ ] )

- This command can be used with a  $1 \times N$  or  $N \times 1$  matrix only ( $N = 2, 3$ ).
- This command returns “x” when “natural number” is 1, “y” when “natural number” is 2, and “z” when “natural number” is 3.
- This command returns a rectangular form when you omit “natural number”.

Example: To transform the polar form  $[\sqrt{2}, \angle(\pi/4)]$  into an equivalent rectangular form (in the Radian mode)

```
toRect([√2, ∠(π/4)])
[1 1]
```

• **toPol** [Action][Vector][toPol]

Function: Returns an equivalent polar form  $[r \angle \theta]$ .

Syntax: toPol (Mat [,natural number] [ ] )

- This command can be used with a  $1 \times 2$  or  $2 \times 1$  matrix only.
- This command returns “r” when “natural number” is 1, and “θ” when “natural number” is 2.
- This command returns a polar form when you omit “natural number”.

Example: To transform the rectangular form [1, 2] into its equivalent polar form

```
toPol([1, 2])
[√5 ∠(-tan⁻¹(1/2) + π/2)]
```

• **toSph** [Action][Vector][toSph]

Function: Returns an equivalent spherical form  $[\rho \angle \theta \angle \phi]$ .

Syntax: toSph (Mat [,natural number] [ ] )

- This command can be used with a  $1 \times 3$  or  $3 \times 1$  matrix only.
- This command returns “ρ” when “natural number” is 1, “θ” when “natural number” is 2, and “φ” when “natural number” is 3.
- This command returns a spherical form when you omit “natural number”.



Example: To transform the rectangular form [1, 1, 1] into its equivalent spherical form (in the Radian mode)

```
toSph([1, 1, 1])

$$\left[ \sqrt{3} \angle \left( \frac{\pi}{4} \right) \angle \left( \cos^{-1} \left( \frac{\sqrt{3}}{3} \right) \right) \right]$$

```

• **toCyl** [Action][Vector][toCyl]

Function: Returns an equivalent cylindrical form  $[r \angle \theta \ z]$ .

Syntax: toCyl (Mat [,natural number] [ ] )

- This command can be used with a  $1 \times 3$  or  $3 \times 1$  matrix only.
- This command returns “r” when “natural number” is 1, “θ” when “natural number” is 2, and “z” when “natural number” is 3.
- This command returns a cylindrical form when you omit “natural number”.

Example: To transform the rectangular form [1, 1, 1] into an equivalent cylindrical form (in the Radian mode)

```
toCyl([1, 1, 1])

$$\left[ \sqrt{2} \angle \left( \frac{\pi}{4} \right) \ 1 \right]$$

```

## Using the Equation/Inequality Submenu

The [Equation/Inequality] submenu contains commands that are related to equations and inequalities.

• **solve** [Action][Equation/Inequality][solve]

Function: Returns the solution of an equation or inequality.

Syntax 1: solve(Exp/Eq/Ineq [,variable] [ ] )

- “x” is the default when you omit “[,variable]”.

Example: To solve  $ax + b = 0$  for  $x$

```
solve(ax+b=0)

$$\left\{ x = \frac{-b}{a} \right\}$$

```

Syntax 2: solve(Exp/Eq/Ineq≠,variable[, value, lower limit, upper limit] [ ] )

- “value” is an initially estimated value.
- This command is valid only for equations and  $\neq$  expressions when “value” and the items following it are included. In that case, this command returns an approximate value.
- A true value is returned when you omit “value” and the items following it. When, however, a true value cannot be obtained, an approximate value is returned for equations only based on the assumption that value = 0, lower limit =  $-\infty$ , and upper limit =  $\infty$ .

Syntax 3: solve({Exp-1/Eq-1, ..., Exp-N/Eq-N}, {variable-1, ..., variable-N} [ ] )

- When “Exp” is the first argument, the equation  $\text{Exp} = 0$  is presumed.

Example: To solve simultaneous linear equations  $3x + 4y = 5$ ,  $2x - 3y = -8$

```
solve({3x+4y=5, 2x-3y=-8}, {x, y})









$$\{x=-1, y=2\}$$

```

You also could input the simultaneous equations shown in this example using the soft keyboard  key. The following shows the required input syntax.

$$\left\{ \begin{array}{l} \text{Exp-1/Eq-1} \\ \vdots \\ \text{Exp-N/Eq-N} \end{array} \right\} \text{ variable-1, ..., variable-N}$$

- The following shows the required key operation to input this example using the  key.



 3  + 4  = 5  2  - 3  = (-) 8   ,  EXE

```

$$\left\{ \begin{array}{l} 3x+4y=5 \\ 2x-3y=-8 \end{array} \right\} x, y$$

$$\{x=-1, y=2\}$$

```

- To input simultaneous equations with three or more unknowns, tap the  key when the cursor is in the Exp-N/Eq-N input field. Each tap of  will add one more line for input of an equation.

Syntax 4: You can solve for the relationship between two points, straight lines, planes, or spheres by entering a vector equation inside the solve( command. Here we will present four typical syntaxes for solving a vector equation using the solve( command.

In the syntaxes below, Vct-1 through Vct-6 are column vectors with three (or two) elements, and  $s$ ,  $t$ ,  $u$  and  $v$  are parameters.

solve(Vct-1 +  $s$  \* Vct-2 [= Vct-3, {variable-1}])

- If the right side of the equation (= Vct-3) is omitted in the above syntax, it is assumed that all of the elements on the right side are 0 vectors.

solve(Vct-1 +  $s$  \* Vct-2 = Vct-3 +  $t$  \* Vct-4, {variable-1, variable-2})

solve(Vct-1 +  $s$  \* Vct-2 +  $t$  \* Vct-3 = Vct-4 -  $u$  \* Vct-5, {variable-1, variable-2, variable-3})

solve(Vct-1 +  $s$  \* Vct-2 +  $t$  \* Vct-3 = Vct-4 -  $u$  \* Vct-5 +  $v$  \* Vct-6, {variable-1, variable-2, variable-3, variable-4})

- Variables (variable 1 through variable 4) can be input into the elements of each vector (Vct-1 through Vct-6) in the above four syntaxes to solve for those variables.

$$\text{solve}\left(\begin{bmatrix} 1 \\ 2 \\ 3 \end{bmatrix} + s \cdot \begin{bmatrix} 4 \\ 5 \\ 6 \end{bmatrix} = \begin{bmatrix} x \\ y \\ z \end{bmatrix}, \{x, y, z\}\right)$$

{ $x=4 \cdot s+1$ ,  $y=5 \cdot s+2$ ,  $z=6 \cdot s+3$ }

**0234** To prove whether point P (5, 7, 9) and point Q (5, 7, 8) each exist on straight line  $l$ , which is an orientation vector (4, 5, 6) that passes through point A (1, 2, 3)

### Note

For the solution, the solve function returns an expression or value for the expression (Exp/Eq) input as its argument. The message “More solutions may exist” will appear on the display when a value is returned as the solution, because there may be multiple solutions.

The solve function can return a maximum of 10 solutions in the case of values.

Example: To solve  $\cos(x) = 0.5$  for  $x$  (initial value: 0)

$$\text{solve}(\cos(x)=0.5, x, 0)$$

{ $x=-780$ ,  $x=-660$ ,  $x=-420$ ,  $x=-300$ ,  $x=-60$ ,  $x=60$ ,  $x=300$ ,  $x=420$ ,  $x=660$ ,  $x=780$ }

(Angle unit setting: Deg)

### • dSolve [Action][Equation/Inequality][dSolve]

Function: Solves first, second or third order ordinary differential equations, or a system of first order differential equations.

Syntax: dSolve(Eq, independent variable, dependent variable [, initial condition-1, initial condition-2][, initial condition-3, initial condition-4][, initial condition-5, initial condition-6] [ ] )

dSolve({Eq-1, Eq-2}, independent variable, {dependent variable-1, dependent variable-2} [, initial condition-1, initial condition-2, initial condition-3, initial condition-4] [ ] )

- If you omit the initial conditions, the solution will include arbitrary constants.
- Input all initial conditions equations using the syntax Var = Exp. Any initial condition that uses any other syntax will be ignored.

Example: To solve a differential equation  $y' = x$ , where  $y = 1$  when  $x = 0$

$$\text{dSolve}(y'=x, x, y, x=0, y=1)$$

{ $y=\frac{x^2}{2}+1$ }

Example: To solve the system of first order differential equations  $y' = y + z$ ,  $z' = y - z$ , where “ $x$ ” is the independent variable, “ $y$ ” and “ $z$ ” are the dependent variables, and the initial conditions are  $y = 3$  when  $x = 0$ , and  $z = \sqrt{2} - 3$  when  $x = 0$

$$\text{dSolve}(\{y'=y+z, z'=y-z\}, x, \{y, z\}, x=0, y=3, z=\sqrt{2}-3)$$

{ $y=2 \cdot e^{\sqrt{2} \cdot x} + e^{-\sqrt{2} \cdot x}$ ,  $z=2 \cdot \sqrt{2} \cdot e^{\sqrt{2} \cdot x} - 2 \cdot e^{\sqrt{2} \cdot x} - \sqrt{2} \cdot e^{-\sqrt{2} \cdot x}$ }

- **rewrite** [Action][Equation/Inequality][rewrite]

Function: Moves the right side elements of an equation or inequality to the left side.

Syntax: `rewrite(Eq/Ineq/List [ ] )`

Example: To move the right side elements of  $x + 3 = 5x - x^2$  to the left side

```
rewrite(x+3=5x-x^2)
x^2-4*x+3=0
```

- **exchange** [Action][Equation/Inequality][exchange]

Function: Swaps the right-side and left-side elements of an equation or inequality.

Syntax: `exchange(Eq/Ineq/List [ ] )`

Example: To swap the left-side and right-side elements of  $3 > 5x - 2y$

```
exchange(3>5x-2y)
5*x-2*y<3
```

- **eliminate** [Action][Equation/Inequality][eliminate]

Function: Solves one equation with respect to a variable, and then replaces the same variable in another expression with the obtained result.

Syntax: `eliminate(Eq/Ineq/List-1, variable, Eq-2 [ ] )`

Example: To transform  $y = 2x + 3$  to  $x =$ , and substitute the result into  $2x + 3y = 5$

```
eliminate(2x+3y=5, x, y=2x+3)
4*y-3=5
```

- **absExpand** [Action][Equation/Inequality][absExpand]

Function: Divides an absolute value expression into formulas without absolute value.

Syntax: `absExpand(Eq/Ineq [ ] )`

Example: To remove the absolute value from  $|2x - 3| = 9$

```
absExpand(|2x-3|=9)
2*x-3=9 or 2*x-3=-9
```

- **andConnect** [Action][Equation/Inequality][andConnect]

Function: Combines two equations or inequalities into a single expression.

Syntax: `andConnect(Eq/Ineq-1, Eq/Ineq-2 [ ] )`

Example: To rewrite  $x > -1$  and  $x < 3$  into a single inequality

```
andConnect(x>-1, x<3)
-1<x<3
```

- **getRight** [Action][Equation/Inequality][getRight]

Function: Extracts the right-side elements of an equation or inequality.

Syntax: `getRight(Eq/Ineq/List [ ] )`

Example: To extract the right side elements of  $y = 2x^2 + 3x + 5$

```
getRight(y=2x^2+3x+5)
2*x^2+3*x+5
```

- **getLeft** [Action][Equation/Inequality][getLeft]

Function: Extracts the left-side elements of an equation or inequality.

Syntax: `getLeft(Eq/Ineq/List [ ] )`

Example: To extract the left side elements of  $y = 2x^2 + 3x + 5$

```
getLeft(y=2x^2+3x+5)
y
```

- **and** [Action][Equation/Inequality][Logic][and]

Function: Returns the result of the logical AND of two expressions.

Syntax: `Exp/Eq/Ineq/List-1 and Exp/Eq/Ineq/List-2`

Example: To obtain the result of the logical AND of  $x^2 > 1$  and  $x < 0$

```
x^2>1 and x<0
x<-1
```

- **or** [Action][Equation/Inequality][Logic][or]

Function: Returns the result of the logical OR of two expressions.

Syntax: Exp/Eq/Ineq/List-1 or Exp/Eq/Ineq/List-2

Example: To obtain the result of the logical OR of  $x = 3$  or  $x > 2$

```
x=3 or x>2
x>2
```

- **xor** [Action][Equation/Inequality][Logic][xor]

Function: Returns the logical exclusive OR of two expressions.

Syntax: Exp/Eq/Ineq/List-1 xor Exp/Eq/Ineq/List-2

Example: To obtain the logical exclusive OR of  $x < 2$  xor  $x < 3$

```
x<2 xor x<3
2≤x<3
```

- **not** [Action][Equation/Inequality][Logic][not]

Function: Returns the logical NOT of an expression.

Syntax: not(Exp/Eq/Ineq/List [ ] )

Example: To obtain the logical NOT of  $x = 1$

```
not(x=1)
x≠1
```

## Using the Assistant Submenu

The [Assistant] submenu contains four commands related to the Assistant mode.

Note that the following commands are valid in the Assistant mode only. For more information on the Assistant mode see “Assistant Mode and Algebra Mode” on page 47.

- **arrange** [Action][Assistant][arrange]

Function: Combines common terms in an expression and returns the result arranged in descending sequence.

Syntax: arrange (Exp/Eq/Ineq/List/Mat [ ] )

Example: To arrange  $2x + 3 - 5x + 8y$  in the sequence of its variables

```
arrange(2x+3-5x+8y)
-3·x+8·y+3
```

- **replace** [Action][Assistant][replace]

Function: Replaces the variable in an expression, equation or inequality with the value assigned to a variable using the “store” command.

Syntax: replace (Exp/Eq/Ineq/List/Mat [ ] )

Example: To replace  $s$  in the expression  $3x + 2s$ , when the expression  $2x + 1$  is assigned to  $s$

```
2x+1→s
replace(3x+2s)
2·(2·x+1)+3·x
```

- **invert** [Action][Assistant][invert]

Function: Inverts two variables in an expression.

Syntax: invert (Exp/Eq/Ineq/List [,variable-1, variable-2] [ ] )

- $x$  and  $y$  are inverted when variables are not specified.

Example: To invert  $x$  and  $y$  in the expression  $2x = y$

```
invert(2x=y)
2·y=x
```

- **Clear\_a\_z**

Function: Clears all single-character variable names (a–z and A–Z) in the current folder.

```
Clear_a_z
done
```

---

## Using the Distribution/Inv.Dist Submenu

The [Distribution/Inv.Dist] submenu includes functions related to each type of statistical calculation distribution probability. The functions on this submenu perform the same calculations as the Distribution commands that are available in the Statistics application and the Main, eActivity, and Program applications.

For information about the numeric expressions used in calculations, see “Distributions” on page 151.

For information about the meanings of the variables used in the syntaxes of the functions presented in this section, and the system variables that store the values obtained as calculation results, see “Input and Output Terms” on page 154.

## Specifying Arguments within the Distribution Function

You can specify either values or list data for any of the arguments within the Distribution function. The normPDF function (page 85) syntax ( $\text{normPDF}(x, \sigma, \mu)$ ) that returns normal probability density can be used to perform the calculations shown below. The “Number Format” setting is “Fix 2” for all calculation results.

$$\text{normPDF}(1, 1, 0) = 0.24$$

$$\text{normPDF}(\{1, 2\}, 1, 0) = \{0.24, 0.05\}$$

$$\text{normPDF}(1, \{1, 2\}, 0) = \{0.24, 0.18\}$$

$$\text{normPDF}(\{1, 2\}, \{1, 2\}, 0) = \{0.24, 0.12\}$$

$$\text{normPDF}(\{1, 2\}, \{1, 2\}, \{1, 0\}) = \{0.40, 0.12\}$$

The following explains how to specify list data in arguments and how calculation results are output.

### (a) Specifying list data for a single argument

- Basically, you can specify any list you like, but the each of the elements in the list must be in accordance with the conditions required by the argument of the function being used.

- Calculation is performed on each element within the list and results are output as shown below.

$$\text{normPDF}(x, \{\sigma_1, \sigma_2\}, \mu)$$

$$= \{\langle \text{normPDF}(x, \sigma_1, \mu) \text{ calculation result} \rangle, \langle \text{normPDF}(x, \sigma_2, \mu) \text{ calculation result} \rangle\}$$

### (b) Specifying list data for multiple arguments

- In this case, all of the lists must have the same number of elements. Otherwise an Invalid Dimension error will occur.

- Calculation is performed on each element within the list and results are output as shown below.

$$\text{normPDF}(\{x_1, x_2\}, \{\sigma_1, \sigma_2\}, \mu)$$

$$= \{\langle \text{normPDF}(x_1, \sigma_1, \mu) \text{ calculation results} \rangle, \langle \text{normPDF}(x_2, \sigma_2, \mu) \text{ calculation results} \rangle\}$$

## Assignment of List Data Calculation Results to Variables

Using the list data in the argument of the Distribution function causes calculation results to be output as list data, which is assigned as-is to the “ans” variable.

In addition to the “ans” variable, calculations that use the Distribution function causes calculation results also to be assigned to certain system variables. For example, the normal probability density variable returned by normPDF is assigned to system variable *prob*. Only the last element of the list data will be assigned to a system variable as a calculation result.

In the distribution function explanations below, the names of the functions to which calculation results are assigned are shown under “Calculation Result Output”.

### • normPDF [Action][Distribution/Inv.Dist][Continuous][normPDF]

Function: Returns the normal probability density for a specified value.

Syntax:  $\text{normPDF}(x, \sigma, \mu)$

- When  $\sigma$  and  $\mu$  are skipped,  $\sigma = 1$  and  $\mu = 0$  are used.

Calculation Result Output: *prob*

Example: To determine the normal probability density when  $x = 37.5$ ,  
 $\sigma = 2$ ,  $\mu = 35$

normPDF (37.5, 2, 35)
0.09132454269

• **normCDF** [Action][Distribution/Inv.Dist][Continuous][normCDF]

Function: Returns the cumulative probability of a normal distribution between a lower bound and an upper bound.

Syntax: normCDF(lower value, upper value[, $\sigma$ ,  $\mu$ ])

- When  $\sigma$  and  $\mu$  are skipped,  $\sigma = 1$  and  $\mu = 0$  are used.

Calculation Result Output: *prob*, *zLow*, *zUp*

Example: To determine the normal probability density when lower bound value =  $-\infty$ , upper bound value = 36,  $\sigma = 2$ ,  $\mu = 35$

```
normCDF(-∞, 36, 2, 35)
0.6914624613
```

• **invNormCDF** [Action][Distribution/Inv.Dist][Inverse][invNormCDF]

Function: Returns the boundary value(s) of a normal cumulative distribution probability for specified values.

Syntax: invNormCDF([tail setting, ]area value[, $\sigma$ ,  $\mu$ ])

- When  $\sigma$  and  $\mu$  are skipped,  $\sigma = 1$  and  $\mu = 0$  are used.
- “tail setting” displays the probability value tail specification, and Left, Right, or Center can be specified. Enter the following values or letters to specify:

Left: -1, “L”, or “l”

Center: 0, “C”, or “c”

Right: 1, “R”, or “r”

When input is skipped, “Left” is used.

- When one argument is omitted (resulting in three arguments), Tail=Left.
- When two arguments are omitted (resulting in two arguments), Tail=Left,  $\mu=0$ .
- When three arguments are omitted (resulting in one argument), Tail=Left,  $\sigma=1$ ,  $\mu=0$ .
- When “tail setting” is Center, the lower bound value is returned.

Calculation Result Output:  $x_1$ InvN,  $x_2$ InvN

Example: To determine the upper bound value when tail setting = Left, area value = 0.7,  $\sigma = 2$ ,  $\mu = 35$

```
invNormCDF("L", 0.7, 2, 35)
36.04880103
```

• **tPDF** [Action][Distribution/Inv.Dist][Continuous][tPDF]

Function: Returns the Student’s *t* probability density for a specified value.

Syntax: tPDF(*x*, *df*[ ] )

Calculation Result Output: *prob*

Example: To determine the Student’s *t* probability density when  $x = 2$ ,  $df = 5$

```
tPDF(2, 5)
0.06509031033
```

• **tCDF** [Action][Distribution/Inv.Dist][Continuous][tCDF]

Function: Returns the cumulative probability of a Student’s *t* distribution between a lower bound and an upper bound.

Syntax: tCDF(lower value, upper value, *df*[ ] )

Calculation Result Output: *prob*, *tLow*, *tUp*

Example: To determine the Student’s *t* distribution probability when lower value = 1.5, upper value =  $\infty$ ,  $df = 18$

```
tCDF(1.5, ∞, 18)
0.07547522609
```

• **invTCDF** [Action][Distribution/Inv.Dist][Inverse][invTCDF]

Function: Returns the lower bound value of a Student's  $t$  cumulative distribution probability for specified values.

Syntax: `invTCDF(prob, df [ ] )`

Calculation Result Output:  $xInv$

Example: To determine the lower bound value when  $prob = 0.0754752$ ,  
 $df = 18$

```
invTCDF(0.0754752, 18)
1.500000203
```

• **chiPDF** [Action][Distribution/Inv.Dist][Continuous][chiPDF]

Function: Returns the  $\chi^2$  probability density for specified values.

Syntax: `chiPDF(x, df [ ] )`

Calculation Result Output:  $prob$

Example: To determine the  $\chi^2$  probability density when  $x = 2$ ,  $df = 4$

```
chiPDF(2, 4)
0.1839397206
```

• **chiCDF** [Action][Distribution/Inv.Dist][Continuous][chiCDF]

Function: Returns the cumulative probability of a  $\chi^2$  distribution between a lower bound and an upper bound.

Syntax: `chiCDF(lower value, upper value, df [ ] )`

Calculation Result Output:  $prob$

Example: To determine the  $\chi^2$  probability when lower value = 2.7,  
upper value =  $\infty$ ,  $df = 4$

```
chiCDF(2.7, ∞, 4)
0.6092146125
```

• **invChiCDF** [Action][Distribution/Inv.Dist][Inverse][invChiCDF]

Function: Returns the lower bound value of a  $\chi^2$  cumulative distribution probability for specified values.

Syntax: `invChiCDF(prob, df [ ] )`

Calculation Result Output:  $xInv$

Example: To determine the lower bound value when  $prob = 0.6092146$ ,  $df = 4$

```
invChiCDF(0.6092146, 4)
2.700000072
```

• **fPDF** [Action][Distribution/Inv.Dist][Continuous][fPDF]

Function: Returns the  $F$  probability density for a specified value.

Syntax: `fPDF(x, n:df, d:df [ ] )`

Calculation Result Output:  $prob$

Example: To determine the  $F$  probability density when  $x = 1.5$ ,  $n:df = 24$ ,  
 $d:df = 19$

```
fPDF(1.5, 24, 19)
0.3951671524
```

• **fCDF** [Action][Distribution/Inv.Dist][Continuous][fCDF]

Function: Returns the cumulative probability of an  $F$  distribution between a lower bound and an upper bound.

Syntax: `fCDF(lower value, upper value, n:df, d:df [ ] )`

Calculation Result Output:  $prob$

Example: To determine the  $F$  distribution probability when lower value = 1.5,  
upper value =  $\infty$ ,  $n:df = 24$ ,  $d:df = 19$

```
fCDF(1.5, ∞, 24, 19)
0.185196483
```

• **invFCDf** [Action][Distribution/Inv.Dist][Inverse][invFCDf]

Function: Returns the lower bound value of an  $F$  cumulative distribution probability for specified values.

Syntax: `invFCDf(prob, n:df, d:df [ ] )`

Calculation Result Output:  $xInv$

Example: To determine the lower bound value when  $prob = 0.1852$ ,  $n:df = 24$ ,  
 $d:df = 19$

• **binomialPDF** [Action][Distribution/Inv.Dist][Discrete][binomialPDF]

Function: Returns the probability in a binomial distribution that the success will occur on a specified trial.

Syntax: `binomialPDF(x, numtrial value, pos [ ] )`

Calculation Result Output:  $prob$

Example: To determine the binomial probability when  $x = 5$ , numtrial value = 3,  
 $pos = 0.63$

• **binomialCDF** [Action][Distribution/Inv.Dist][Discrete][binomialCDF]

Function: Returns the cumulative probability in a binomial distribution that the success will occur between specified lower value and upper value.

Syntax: `binomialCDF(lower value, upper value, numtrial value, pos [ ] )`

Calculation Result Output:  $prob$

Example: To determine the binomial cumulative probability when lower value  
= 2, upper value = 5, numtrial value = 3,  $pos = 0.63$

• **invBinomialCDF** [Action][Distribution/Inv.Dist][Inverse][invBinomialCDF]

Function: Returns the minimum number of trials of a binomial cumulative probability distribution for specified values.

Syntax: `invBinomialCDF(prob, numtrial value, pos [ ] )`

Calculation Result Output:  $xInv$ ,  $*xInv$

**Important!**

When executing the `invBinomialCDF`, `invPoissonCDF`, `invGeoCDF`, or `invHypergeoCDF` function, the ClassPad uses the specified  $prob$  value and the value that is one less the  $prob$  value minimum number of significant digits ( $*prob$  value) to calculate minimum number of trials values. The results are assigned to the system variables  $xInv$  (calculation result using  $prob$ ) and  $*xInv$  (calculation result using  $*prob$ ). The function always returns the  $xInv$  value only. However, when the  $xInv$  and  $*xInv$  values are different, the warning message shown nearby appears showing both values.

The calculation results of the function are integers. Accuracy may be reduced when the first argument has 10 or more digits. Note that even a slight difference in calculation accuracy affects calculation results. If a warning message appears, check the displayed values.

Example: To determine the minimum number of trials when  $prob = 0.609$ ,  
numtrial value = 5,  $pos = 0.63$

• **poissonPDF** [Action][Distribution/Inv.Dist][Discrete][poissonPDF]

Function: Returns the probability in a Poisson distribution that the success will occur on a specified trial.

Syntax: `poissonPDF(x,  $\lambda$  [ ] )`

Calculation Result Output:  $prob$

Example: To determine the Poisson probability when  $x = 10$ ,  $\lambda = 6$



• **poissonCDF** [Action][Distribution/Inv.Dist][Discrete][poissonCDF]

Function: Returns the cumulative probability in a Poisson distribution that the success will occur between specified lower value and upper value.

Syntax: poissonCDF(lower value, upper value,  $\lambda$  [ ] )

Calculation Result Output: *prob*

Example: To determine the Poisson cumulative probability when lower value = 2, upper value = 3,  $\lambda = 2.26$

```
poissonCDF(2, 3, 2.26)
0.4672462698
```

• **invPoissonCDF** [Action][Distribution/Inv.Dist][Inverse][invPoissonCDF]

Function: Returns the minimum number of trials of a Poisson cumulative probability distribution for specified values.

Syntax: invPoissonCDF(*prob*,  $\lambda$  [ ] )

Calculation Result Output: *xInv*, \**xInv*

**Important!**

See “Important!” under “invBinomialCDF” on page 88.

Example: To determine the minimum number of trials when *prob* = 0.8074,  $\lambda = 2.26$

```
invPoissonCDF(0.8074, 2.26)
3
```

• **geoPDF** [Action][Distribution/Inv.Dist][Discrete][geoPDF]

Function: Returns the probability in a geometric distribution that the success will occur on a specified trial.

Syntax: geoPDF(*x*, *pos* [ ] )

Calculation Result Output: *prob*

Example: To determine the geometric probability when *x* = 6, *pos* = 0.4

```
geoPDF(6, 0.4)
0.031104
```

• **geoCDF** [Action][Distribution/Inv.Dist][Discrete][geoCDF]

Function: Returns the cumulative probability in a geometric distribution that the success will occur between specified lower value and upper value.

Syntax: geoCDF(lower value, upper value, *pos* [ ] )

Calculation Result Output: *prob*

Example: To determine the geometric probability when lower value = 2, upper value = 3, *pos* = 0.5

```
geoCDF(2, 3, 0.5)
0.375
```

• **invGeoCDF** [Action][Distribution/Inv.Dist][Inverse][invGeoCDF]

Function: Returns the minimum number of trials of a geometric cumulative probability distribution for specified values.

Syntax: invGeoCDF(*prob*, *pos* [ ] )

Calculation Result Output: *xInv*, \**xInv*

**Important!**

See “Important!” under “invBinomialCDF” on page 88.

Example: To determine the minimum number of trials when *prob* = 0.875, *pos* = 0.5

```
invGeoCDF(0.875, 0.5)
3
```

- **hypergeoPdf** [Action][Distribution/Inv.Dist][Discrete][hypergeoPdf]

Function: Returns the probability in a hypergeometric distribution that the success will occur on a specified trial.

Syntax: `hypergeoPdf(x, n, M, N [ ] )`

Calculation Result Output: *prob*

Example: Determine the hypergeometric probability when  $x = 1$ ,  $n = 5$ ,  
 $M = 10$ ,  $N = 20$ .

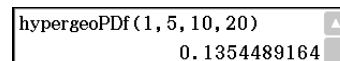

- **hypergeoCdf** [Action][Distribution/Inv.Dist][Discrete][hypergeoCdf]

Function: Returns the cumulative probability in a hypergeometric distribution that the success will occur between specified lower value and upper value.

Syntax: `hypergeoCdf(lower value, upper value, n, M, N [ ] )`

Calculation Result Output: *prob*

Example: Determine the hypergeometric cumulative distribution when lower value = 0, upper value = 1,  $n = 5$ ,  $M = 10$ ,  $N = 20$ .

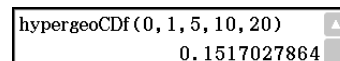

- **invHypergeoCdf** [Action][Distribution/Inv.Dist][Inverse][invHypergeoCdf]

Function: Returns the minimum number of trials of a hypergeometric cumulative distribution for specified values.

Syntax: `invHypergeoCdf(prob, n, M, N [ ] )`

Calculation Result Output: *xInv*, \**xInv*

**Important!**

See “Important!” under “invBinomialCdf” on page 88.

Example: To determine the minimum number of trials when  $prob = 0.3$ ,  $n = 5$ ,  
 $M = 10$ ,  $N = 20$

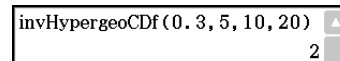

## Using the Financial Submenu

The [Financial] submenu contains commands that are related to financial calculations.

For information about the functions included in this submenu, see “11-4 Financial Calculation Functions”.

## Using the Command Submenu

- **Define**

Function 1: Defines function and registers it with Graph Editor.

Syntax 1: `Define{y1(x) – y100(x) ; x1(y) – x100(y) ; yt1(t) – yt100(t) ; xt1(t) – xt100(t) ; r1(θ) – r100(θ)} = <expression>`

Example: To define the function  $y = \sin(x)$  and assign it to line “y3” of the Graph Editor

Function 2: Creates a user-defined function.

For more information, see “12-3 User-defined Functions”.

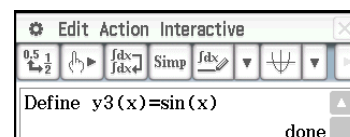

- **DispStat**

Function: Displays previous statistical calculation results.

For more information, see “DispStat” on page 209 and the examples **1208** through **1210** under “Including Statistical Graphing and Calculation Functions in a Program” on page 225.

- **Clear\_a\_z**

Function: Clears all single-character variables.

For more information, see “Clear\_a\_z” on page 84.

- **DelVar**

Function: Deletes a specified variable.

For more information, see “DelVar” on page 208.

- **Clear All Variables**

Function: Clear variables that contain numbers, list and matrices.

## 2-8 Using the Interactive Menu

The [Interactive] menu includes most of the commands that are on the [Action] menu. Selecting a command on the [Action] menu will simply input the command.

With the [Interactive] menu, you drag the stylus across existing input in the work area and then select a command. This encloses the highlighted expression with the command and opens a dialog box if more arguments are needed. When you select an [Interactive] menu item without highlighting an expression first, a dialog box will open prompting you for the necessary arguments.

### Tip

- Operation of the following [Interactive] menu commands is identical to the same commands on the [Action] menu. For information about using these commands, see “2-7 Using the Action Menu”.  
[Transformation], [Advanced], [Calculation], [Complex], [List]-[Create], [List]-[Statistics], [List]-[Calculation], [Matrix]-[Create], [Matrix]-[Calculation], [Matrix]-[Row&Column], [Vector], [Equation/Inequality], [Assistant], [Distribution/Inv.Dist], [Financial], Define
- The “DispStat”, “Clear\_a\_z,” and “DelVar” commands of the [Action] menu’s [Command] submenu are not included on the [Interactive] menu.

---

### Interactive Menu Example

[Interactive] menu operations come in handy in the following cases.

- When you want to use a command on an expression you are calculating
- When you want to use a command that requires multiple arguments

**0235** To factorize the expression  $x^3 - 3x^2 + 3x - 1$

**0236** To obtain the definite integral of  $x^2 + 2x$ ,  $1 \leq x \leq 2$

---

### Using the “apply” Command

The “apply” command is included on the [Interactive] menu only. You can use this command to execute only a specific part of an expression and display its result.

**0237** To calculate the result of  $\text{diff}(\sin(x),x) \times \cos(x) + \sin(x) \times \text{diff}(\cos(x),x)$ , and then calculate only part of the expression

**Note:** This example assumes that your ClassPad is configured with the following mode settings:  
Algebra, Complex, Radian, Descending Order.

## 2-9 Using the Main Application in Combination with Other Applications

You can access the windows of other ClassPad applications from the Main application and perform copy, paste, drag and drop, and other operations between them.

### Tip

- Copying data that includes color information from another application and pasting it into the Main application will cause the color information to be disregarded, and the pasted data will become black. This is also true when dragging data from another application to the Main application.
- Copying data in the Main application and pasting it into another application will cause the pasted data to be displayed in accordance with the other application's color settings. This is also true when dragging data from the Main application to another application.

### Using Another Application's Window

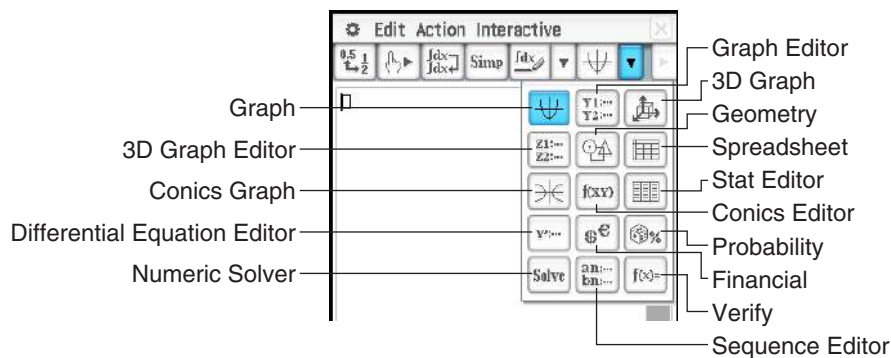

#### • To open another application's window

1. Tap the right most toolbar down arrow button.
  - This displays a palette of application icons.





2. Tap the button that corresponds to the window you want to display.
  - This causes the window that corresponds to the button you tap to appear in the lower window.

#### • To close another application's window

1. Tap anywhere inside of the window you would like to close.
2. Tap the  button in the upper right corner, or tap  and then [Close].
  - The Main application work area expands to fill the entire display.

### Tip

- Even if you used the icon panel  icon to expand the lower window to fill the entire display, tapping  and then [Close] closes it and returns to the work area window.
- Nothing happens if you tap  and then [Close] while the work area window is active.

#### • To copy an expression in the work area and paste it into the Graph Editor window

**0238** To copy " $x^2 - 1$ " in the work area and paste it into the Graph Editor window

- For more information about the Graph Editor window, see Chapter 3.

#### • To graph a function by dragging it from the work area to the Graph window

**0239** To graph the expression " $x^2 - 1$ ", which has already been input into the work area

- As can be seen in this example, a graph can be drawn by dropping an expression in the form of  $f(x)$  into the Graph window.
- When dropping a formula into the 3D Graph window instead of the Graph window, the formula must be in form  $f(x, y)$  (such as  $x^2+y^2$ ).

## Using the Stat Editor Window

You can use the Stat Editor window to create new LIST variables and edit existing LIST variables. You can also use the Stat Editor window to specify a LIST variable's name and display its contents.

### • To use a LIST variable with data input using Stat Editor to perform a calculation in the work area

**0240** To input data into "list1" and "list2" using Stat Editor, and then perform the calculation list1+list2 in the work area

- list1 through list6 are LIST type system variables. For more information, see "Main Memory Data Types" (page 28).
- For information about inputting and editing list data using the Stat Editor, see Chapter 7.

### • To use Stat Editor to recall a LIST variable created in the work area

**0241** Continuing from example **0240**, to use Stat Editor to recall list variable "test", which was created in the work area

## Using the Geometry Window

When there is a Geometry window on the display, you can drag values and expressions to the Geometry window to draw the graph or figure of the value or expression. You can also drag a figure from the Geometry window to the work area, which displays the corresponding expression or value.

### • To drag an expression from the work area to the Geometry window

**0242** To input the expression  $x^2/5^2 + y^2/2^2 = 1$  in the work area, and then drag it to the Geometry window

**Tip:** The following table shows the types of expressions you can drop into the Geometry window. When the expression is not recognized, Geometry displays it as text.

Dropping this into the Geometry window:	Displays this:
Linear equation in $x$ and $y$	An infinite line
Equation of circle in $x$ and $y$	A circle
Equation of ellipse in $x$ and $y$	An ellipse
Equation of hyperbola in $x$ and $y$	A hyperbola
2-dimensional vector (2 rows $\times$ 1 column format)	A point
Equation $y = f(x)$	A curve
$2 \times n$ matrix, $n \geq 3$	A polygon (each column represents a vertex of the polygon)
$n \times 2$ matrix, $n \geq 3$	An open polygon

### • To drag a figure from the Geometry window to the work area

**0243** To drag a point, circle, point and its image from the Geometry window to the work area

- For details about Geometry window operations, see Chapter 8.

**Tip:** The following shows what happens when you drag a figure from the Geometry window to the work area.

Dropping this into the work area:	Displays this:
Point	Coordinates as a vector ( $2 \times 1$ matrix)
Line	Equation of the line
Vector	An ordered pair (head of vector assuming the tail is at the origin)
Circle, Arc, Ellipse, Function, or Curve	Corresponding equation
Polygon	$2 \times n$ matrix
Open Polygon (Created by Animation)	$n \times 2$ matrix
Line Pair	Simultaneous equations for the pair
A point and its image under a transformation	Matrix expression for the transformation

## 2-10 Using Verify





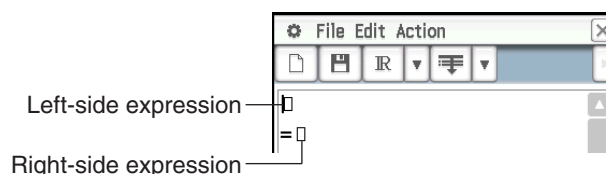

Verify provides you with a powerful tool to check whether your numeric or algebraic manipulations are correct. Verify will assist you in simplifying an expression by verifying whether or not the expression you entered is equivalent to your original expression. If it is, you will get a pleasant response; if not, you will need to correct your mistake before continuing.

### • To start up Verify

1. On the work area window, tap the right most toolbar down arrow button.
2. On the icon palette that appears, tap .



### • Verify window menus and buttons

- Clear the Verify window ..... File - New, Edit - Clear All or 
- Open or save a file ..... File - Open, File - Save or 
- Specify the complex number calculation range for Verify ..... 
- Specify the real number calculation range for Verify ..... 
- Specify the positive real number calculation range for Verify ..... 
- Verify the equation starting from the first line..... 
- Verify the equation starting from the current line ..... 

**0244** To factor 50 completely

**0245** Continuing from example **0244**, to rewrite  $x^2 + 1$  in factored form

## 2-11 Using Probability

You can use Probability to simulate the following.

- The die faces that will appear when a single die is thrown a specified number of times (1 Die)
- The sum of the data of dice faces that will appear when a pair of dice is thrown a specified number of times (2 Dice +)
- The product of the data of dice faces that will appear when a pair of dice is thrown a specified number of times (2 Dice \*)
- When any number of balls labeled A, B, C, D, E, and F are placed into a box, data about how many times each ball will be drawn within a specified number of draws (Container)

You can specify any integer from 1 to 20 as the number of die faces.



Probability dialog box

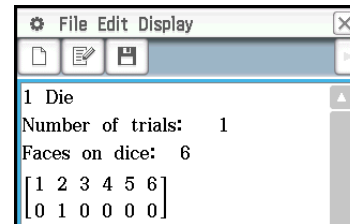

Probability window  
(Trial information and result)

### • To start up Probability

1. On the work area window, tap the right most toolbar down arrow button.
2. On the icon palette that appears, tap . This will display an initial Probability dialog box.

### • Probability window menus and buttons

- Clear the Probability window (and display the Probability dialog box) ..... File - New, Edit - Clear All or
- Display the Probability dialog box and try the probability emulation (the trial result will be added to the end of the current file) ..... Edit - Add or
- Open or save a file ..... File - Open, File - Save or
- Delete the currently selected trial data ..... Edit - Delete
- Show the selected result as a frequency distribution table (in matrix form) ..... Display - Distribution
- Show the selected result as sample data (in list form) ..... Display - Sample Data

**0246** To obtain the sum data when a two six-sided die are thrown 50 times

**0247** After putting 10 A-balls, 20 B-balls, and 30 C-balls into a box, determine how many times each type of ball will be drawn when there is a total of 50 draws. Each time a ball is drawn, it should be replaced into the box before the next draw.

**Tip:** Under initial default settings, trial results are shown as a frequency distribution table in matrix form. Selecting distribution table results and selecting [Sample Data] on the [Display] menu will change them to sample data in list form. Conversely, selecting sample data results and selecting [Distribution] on the [Display] menu will change them to distribution table results.

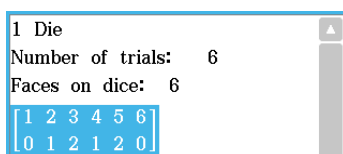

Distribution table (matrix form)

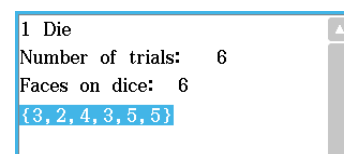

Sample data (list form)

## 2-12 Running a Program in the Main Application

You can run a program in the Main application or the eActivity application.

**Syntax:** Folder name\Program name(parameter)

- You do not need to specify the folder name if the program you want to run is in the current folder. If you leave ClassPad configured with its initial default settings, the current folder for both the Program application and the Main application is the “main” folder, so you normally do not need to specify a folder name.
- Unless you change it, the current folder of the eActivity application is the “eAct” folder, so you always need to specify the folder name. If you want to run a program that is in the “main” folder, input “main\Program name(parameter)”.

### **Important!**

If the program command “Pause” is used in a program, it is ignored when the program is called from Main or eActivity.

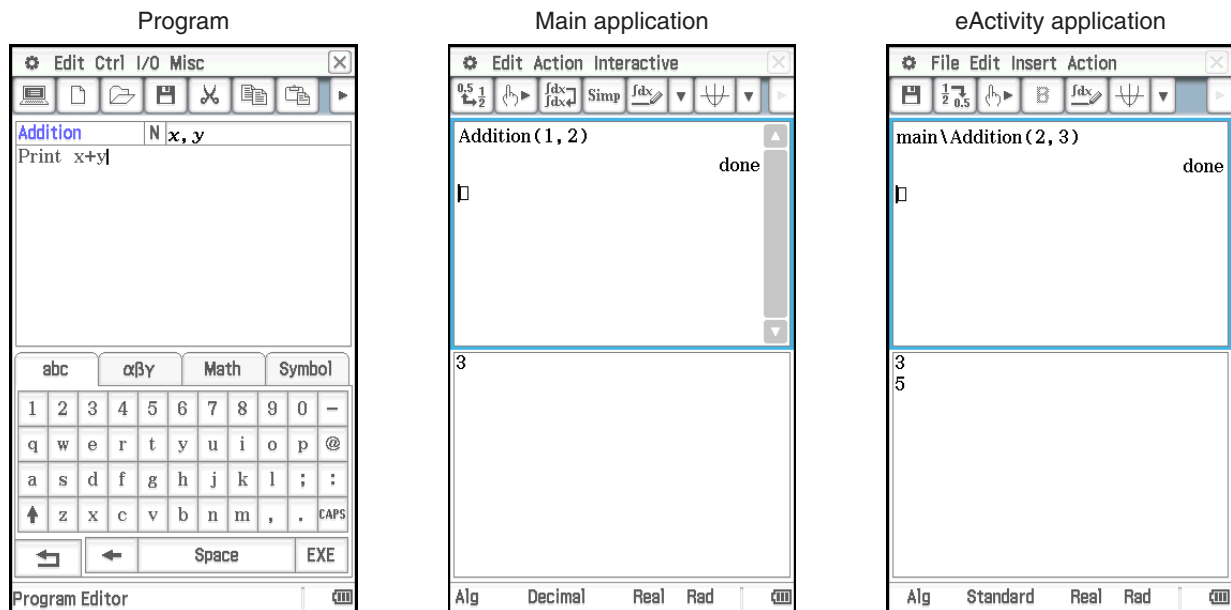

- 0248** To run the program named OCTA that we created and stored under “Creating a Program” (page 197) from the Main application, and determine the surface area and volume of a regular octahedron with a side length of 20 cm



# Chapter 3: Graph & Table Application

The Graph & Table application allows you to input and graph rectangular coordinate equations (or inequalities), polar coordinate equations, and parametric expressions. After you graph an expression, you can perform various graph-based analytical operations, such as determining the points of intersection of two graphs, point of inflection, and definite integral for a particular range of a parabola or other figure.

When you start up the Graph & Table application, two windows appear on the display: ① the Graph Editor window and ② the Graph window.



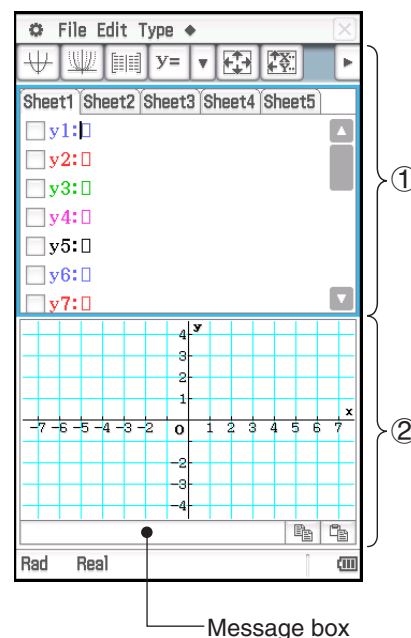

- A Graph Editor sheet can contain up to 20 functions. You can have up to 100 functions stored in the Graph Editor at one time. Functions stored in the Graph Editor can be graphed on the Graph window.
- You can also use a function on the Graph Editor window to generate a number table or a summary table. Number tables and summary tables are displayed in a Table window.
- The Graph window and Table window have a message box along the bottom that can display expressions and values, or they can be used for input and editing.















## Graph & Table Application-Specific Menus and Buttons

### Graph Editor window









- Open batch saved data in the Graph Editor window..... File - Open Graph Memory
- Save all of the expressions on the Graph Editor window..... File - Save Graph Memory
- Select the entire expression you are editing ..... Edit - Select All
- Clear all of the expressions from the Graph Editor window ..... Edit - Clear All
- Input a rectangular coordinate type function..... Type -  $y=$ Type or  $y=$
- Input a polar coordinate type function..... Type -  $r=$ Type or  $r=$
- Input a parametric function ..... Type - ParamType or  $x=t=$
- Input an  $x$  equality..... Type -  $x=$ Type or  $x=$
- Input a rectangular coordinate type inequality  
..... Type - Inequality -  $y>$ Type,  $y<$ Type,  $y\geq$ Type,  $y\leq$ Type or  $y>$ ,  $y<$ ,  $y\geq$ ,  $y\leq$
- Input an  $x$  inequality ..... Type - Inequality -  $x>$ Type,  $x<$ Type,  $x\geq$ Type,  $x\leq$ Type or  $x>$ ,  $x<$ ,  $x\geq$ ,  $x\leq$
- Input two functions in a list and shade between them ..... Type - ShadeType or  $y\blacklozenge$
- Start modifying multiple graphs (Dynamic Modify, page 115).....  $\blacklozenge$  - Dynamic Graph or  $\text{Dynamic}$
- Display the Draw Shade dialog box (page 101).....  $\blacklozenge$  - Draw Shade
- Use a built-in function template for graphing .....  $\blacklozenge$  - Built-In
- Delete all of the expressions on the active sheet.....  $\blacklozenge$  - Sheet - Clear Sheet
- Return the active sheet name to its initial default .....  $\blacklozenge$  - Sheet - Default Name

- Graph the selected function(s)..... 
- Generate a summary table for the selected function ..... 
- Display the View Window dialog box to configure Graph window settings ..... 
- Display the Table Input dialog box for configuring settings..... 
- Generate a table for the selected function ..... 

### Graph window

- Clear all of the Graph window contents ..... Edit - Clear All
- Perform a zoom operation (page 105) ..... Zoom
- Display the coordinates at a particular point on a graph..... Analysis - Trace or 
- Insert a point, a graphic, or text into an existing graph (page 112)..... Analysis - Sketch
- Perform a G-Solve operation (page 114)..... Analysis - G-Solve
- Modify a graph by changing the value of a parameter..... Analysis - Modify
- Open the image of a graph .....  - Open Picture
- Save a graph as image data .....  - Save Picture
- Clear the image of a graph .....  - Clear Picture
- Adjust the lightness of the graph screen background image placed by the “Open Picture” command .....  - Fade I/O
- Start modifying multiple graphs (Dynamic Modify, page 115).....  - Dynamic Graph or 
- Display the Draw Shade dialog box .....  - Draw Shade
- Re-draw a graph .....  - ReDraw
- Make the Graph Editor window active ..... 
- Generate a number table for an existing graph ..... 
- Display the Table Input dialog box for configuring settings..... 
- Generate a summary table for an existing graph..... 

### Table window

- Clear all of the Table window contents ..... Edit - Clear All
- Delete a row from a table..... T-Fact - Delete
- Insert a row into a table..... T-Fact - Insert
- Add a row after the currently selected row ..... T-Fact - Add
- Draw a connect type graph using a generated table ..... Graph - G-Connect or 
- Draw a plot type graph using a generated table ..... Graph - G-Plot or 
- Save the contents of a table to a list .....  - Table to List
- Re-generate a table based on current table settings .....  - ReTable
- Delete the displayed table.....  - Delete Table
- Move the pointer to the location on a graph that corresponds to the value selected in a table .....  - Link
- Make the Graph Editor window active ..... 
- Display the Table Input dialog box for configuring settings..... 



## 3-1 Storing Functions

Use the Graph Editor window to store a Graph & Table application function. This section covers Graph Editor operations, and explains how to store functions.

### Using Graph Editor Sheets

The Graph Editor window has five tabbed sheets named Sheet 1 through Sheet 5, each of which can contain up to 20 functions. You can graph up to 20 functions simultaneously, as long as all of the functions are on the same sheet.

The table below explains Graph Editor sheet operations.

To do this:	Do this:
Select a sheet	Tap the tab of the sheet you want to select. The currently selected sheet is the “active” sheet.
Rename a sheet	Tap the tab of the active sheet. On the dialog box that appears, enter up to 8 bytes for the sheet name, and then tap [OK].
Return the active sheet name to its initial default	Tap  , [Sheet], and then [Default Name].
Initialize a Sheet	Tap  , [Sheet], and then [Clear Sheet]. This clears all of the active sheet functions and renames the sheet to its default name.
Initialize all the Sheets	Tap [Edit], and then [Clear All]. In response to the confirmation dialog box that appears, tap [OK]. This clears all of the expressions from the Graph Editor window and returns the sheet names to their initial default names (Sheet 1 through Sheet 5).

### Storing a Function

To input an expression, tap a blank line on the Graph Editor window and then perform the operations described below.

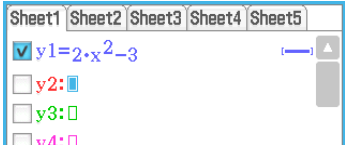
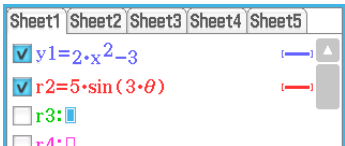
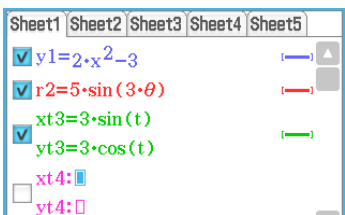
To input this type of expression:	Do this:	
Rectangular coordinate expression ( $y = f(x)$ )	<ol style="list-style-type: none"> <li>Tap [Type] - [y=Type].</li> <li>Input an expression (such as: <math>2x^2 - 3</math>) that contains variable <math>x</math> and then press <b>[EXE]</b>.</li> </ol>	
Polar coordinate expression	<ol style="list-style-type: none"> <li>Tap [Type] - [r=Type].</li> <li>Input an expression (such as: <math>5\sin(3\theta)</math>) that contains variable <math>\theta</math> and then press <b>[EXE]</b>.</li> </ol>	
Parametric expressions	<ol style="list-style-type: none"> <li>Tap [Type] - [ParamType].</li> <li>In the <math>xt =</math>, <math>yt =</math> lines, input expressions that each contain <math>t</math> (such as: <math>3\sin(t)</math>, <math>3\cos(t)</math>), and then press <b>[EXE]</b>.</li> </ol>	

To input this type of expression:	Do this:
$x$ equality	<ol style="list-style-type: none"> <li>1. Tap [Type] - [<math>x</math>=Type].</li> <li>2. Input an expression that includes variable <math>y</math> and then press <b>EXE</b>.</li> </ol>
$y$ inequality (left side $y$ type)	<ol style="list-style-type: none"> <li>1. Tap [Type], [Inequality], and then tap one of the following: [<math>y</math>&gt;Type], [<math>y</math>&lt;Type], [<math>y</math>≥Type], [<math>y</math>≤Type].</li> <li>2. Input an expression that includes variable <math>x</math> and then press <b>EXE</b>.</li> </ol>
$x$ inequality (left side $x$ type)	<ol style="list-style-type: none"> <li>1. Tap [Type], [Inequality], and then tap one of the following: [<math>x</math>&gt;Type], [<math>x</math>&lt;Type], [<math>x</math>≥Type], [<math>x</math>≤Type].</li> <li>2. Input an expression that includes variable <math>y</math> and then press <b>EXE</b>.</li> </ol>
Shade Type	See “Shading the Region Bounded by Two Expressions” (page 101).

**Tip:** You can change the equality/inequality sign of an  $x$ -type ( $x$ =,  $x$ >,  $x$ <,  $x$ ≥,  $x$ ≤) or  $y$ -type ( $y$ =,  $y$ >,  $y$ <,  $y$ ≥,  $y$ ≤, Shade Type) expression after you input it. Simply tap the current equality/inequality sign. On the Type dialog box that appears, select the sign you want and then tap [OK].

## Graphing a Stored Function

You can select multiple functions and graph them simultaneously, as long as all of the functions are on the same sheet. You can turn graphing of each function on or off, and even specify the line style and color to be used for each function.

### • To graph a specified function

1. Tap the tab of the sheet that contains the functions you want to graph to make it active.
2. Select the check boxes of all the functions you want to graph, and clear the check boxes of all the functions you do not want to graph.
3. You can tap the current line style and color to specify another style, if you want.
  - See “To specify the graph line style and color” below.
4. Tap  to graph.

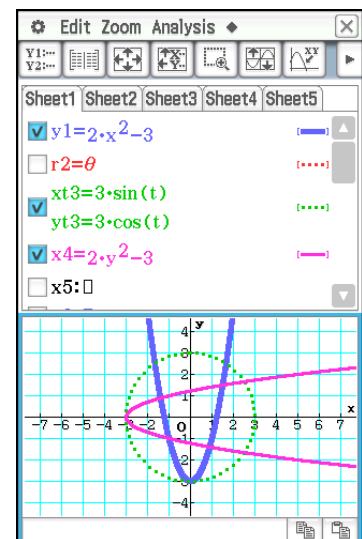

### • To specify the graph line style and color

1. Tap the style area next to the function whose line style and color you want to specify. This displays the Style Settings dialog box.

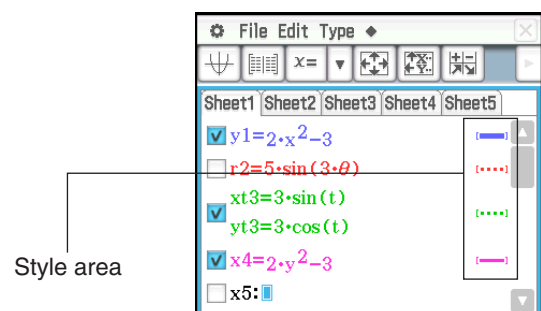

2. Configure the dialog box with the following settings.

To specify this:	Perform this operation:
Line type	Tap "Graph Plot" and then tap the desired line type.
Line color	Tap "Line Color" and then tap the desired color.

3. To apply the settings, return to the dialog box in step 2 of this procedure and then tap [OK].

## Shading the Region Bounded by Two Expressions

You can shade the region bounded by two expressions by specifying [ShadeType] as the function type and then inputting the expressions in the syntax shown below.

{lower function  $f(x)$ , upper function  $g(x)$ } |  $A < x < B$

**Note:**  $A < x < B$  can be omitted.  $A < x < B$  can be replaced with  $x > A$  or  $x < B$ .

### • To shade the region bounded by two expressions

1. Tap [Type] - [ShadeType].
2. Use the above syntax to input two  $x$ -variable expressions, specify the  $x$ -value range, and then press [EXE].

Example:  $\{x^2 - 1, -x^2 + 1\} | -1 < x < 1$

3. Tap  $\Psi$  to graph.

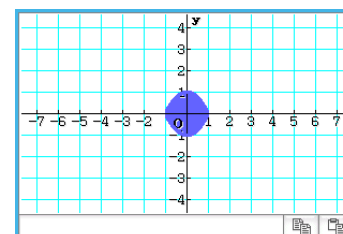

**0301** To use the draw shade dialog box to shade the region bounded by  $x^2 - 1$  and  $-x^2 + 1$

## Overlaying Two Inequalities in an Intersection Plot / Union Plot

Use the following procedure to overlay two inequalities in an Intersection Plot or Union Plot, which are described below.

**Intersection Plot:** Only the parts of the inequalities that overlap are shaded.

**Union Plot:** The inequalities are overlaid as they are.

### • To overlay two inequalities

$$y < x^2, y \leq x + 1$$

1. Store  $y < x^2$  in line y1 and  $y \leq x + 1$  in line y2.
2. On the  $\text{⚙}$  menu, tap [Graph Format].
3. On the Graph Format dialog box that appears, tap the [Inequality Plot] down arrow and then select [Intersection] or [Union].
4. Tap  $\Psi$  to graph.

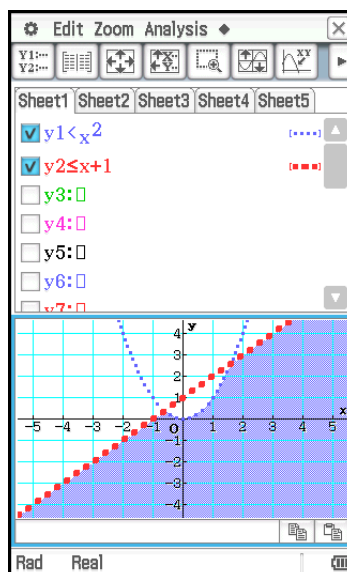

Intersection Plot

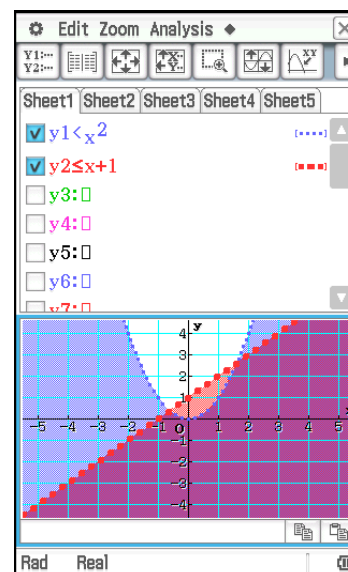

Union Plot

---

## Saving Graph Editor Data to Graph Memory

Graph memory lets you store all of the expressions and their related information to a file for later recall. Each graph memory file contains the following data:

- Functions on all five Graph Editor sheets (up to 100 functions)
- Whether the check box next to each function is selected (checked) or cleared (unchecked)
- The line style and color of each function
- The graph type of each function
- The View Window settings
- Which sheet is currently active
- Sheet names

### • To open a graph memory file

1. Tap [File] and then [Open Graph Memory]. This displays a list of names of graph memory files you have stored in memory.
2. Select the name of the graph memory file you want, and then tap [OK].

### • To save Graph Editor data to graph memory

1. On the Graph Editor window, tap [File] and then [Save Graph Memory]. This displays a dialog box for inputting a name for the graph memory file.
2. Enter the name and then tap [OK].

## 3-2 Using the Graph Window

This section explains Graph window operations, including configuring display settings, scrolling, zooming the image, and more.

---

### Configuring View Window Parameters for the Graph Window

The View Window dialog box lets you specify the maximum and minimum values for each axis, the space between the marks on each axis (the scale), and other graph display parameters. Before drawing a graph, be sure to first configure View Window parameters to ensure proper display of the graph.

### • To configure View Window parameters

**Note:** Steps 2 and 3 of the procedure below can be performed in reverse, if you want, as long as step 4 is performed next.

1. Tap , or tap  and then [View Window] to display the View Window dialog box.

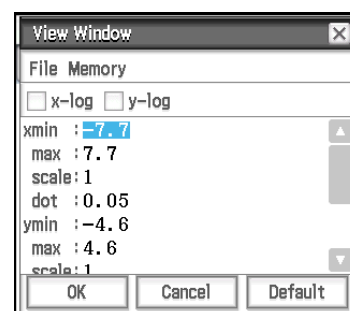

2. If you want to configure settings using preset ClassPad View Window parameters, perform the operations described below.

To configure this setting:	Do this:
ClassPad initial defaults	On the [Memory] menu select [Initial], or tap the [Default] button.
Configure settings optimized for trigonometric function graphing	On the [Memory] menu, select [Trigonometric].
Display both the $x$ -axis and $y$ -axis in a range of $-10$ to $10$	On the [Memory] menu, select [Standard].
Configure View Window settings that maintain the current background image	On the [Memory] menu, select [Picture].
Configure parameters automatically optimized for a graph	On the [Memory] menu, select [Auto].

- For details about each preset parameter, see “View Window Preset Parameters” (page 103).

3. Configure View Window parameters required for the type of graph you want to draw.

### Rectangular Coordinates

Use this item:	To configure this View Window parameter:
$x_{\min}/y_{\min}$	$x$ -axis/ $y$ -axis minimum value
$x_{\max}/y_{\max}$	$x$ -axis/ $y$ -axis maximum value (Specify a value greater than $x_{\min}/y_{\min}$ .)
$x_{\text{scale}}/y_{\text{scale}}$	$x$ -axis/ $y$ -axis marker spacing
$x_{\text{dot}}/y_{\text{dot}}$	Value of each dot on the $x$ -axis/ $y$ -axis

- Selecting the  $x$ -log and/or  $y$ -log check box at the top of the display will switch the applicable axis to logarithmic scale. Selecting one of the check boxes results in a semi-log graph, while selecting both check boxes results in a log-log graph.

### Polar Coordinates and Parametric Coordinates

Use this item:	To configure this View Window parameter:
$t\theta$ min/ $t\theta$ max	Minimum/maximum value of $t\theta$
$t\theta$ step	Step size of $t\theta$ (Specify a non-zero value.)

4. After all the parameters are the way you want, tap [OK].

- When you tap [OK] after changing View Window dialog box settings, the graph is redrawn automatically using the new View Window settings.

### View Window Preset Parameters

Selecting preset View Window parameters configures the settings shown in the table below.

#### Note

- The values in the explanations below apply during the vertical half-size view of the Graph window (which is the initial default setting of the Graph & Table application). Tapping  on the icon panel will switch to the full-screen view and change the View Window settings.
- The View Window settings will differ from those shown below when the Graph window is displayed using the horizontal view.

Parameter Name	Description
Initial (Default)	<ul style="list-style-type: none"> <li>• Both <math>x_{\text{scale}}</math> and <math>y_{\text{scale}}</math> are set to 1. The <math>x</math>-axis direction is displayed from <math>-7.7</math> (<math>x_{\min}</math>) to <math>7.7</math> (<math>x_{\max}</math>), while the <math>y</math>-axis direction is from <math>-4.6</math> (<math>y_{\min}</math>) to <math>4.6</math> (<math>y_{\max}</math>).</li> <li>• The following settings are configured: <math>t\theta_{\min} = 0</math>, <math>t\theta_{\max} = 2\pi^*</math> radian = 360 degree = 400 grad, <math>t\theta_{\text{step}} = (t\theta_{\max} - t\theta_{\min})/120^*</math>. The values depend on the Basic Format Angle setting.</li> </ul>

Parameter Name	Description
Trigonometric	<ul style="list-style-type: none"> <li>• <math>x</math>scale is set to <math>\pi/2^*</math> radian = 90 degree = 100 grad. The values depend on the Basic Format Angle setting. This <math>x</math>scale is used as the basis to display an <math>x</math>-axis direction in the range of <math>x</math>scale <math>\times</math> <math>-7.7</math> (<math>x</math>min) to <math>x</math>scale <math>\times</math> <math>7.7</math> (<math>x</math>max). For example, when the Angle setting is Degree, <math>x</math>min = <math>-693</math>, <math>x</math>max = <math>693</math>.</li> <li>• <math>y</math>-axis settings are fixed as follows, regardless of the Angle setting: <math>y</math>scale = 1, <math>y</math>min = <math>-2.1</math>, <math>y</math>max = <math>2.1</math>.</li> <li>• <math>t\theta</math>min, <math>t\theta</math>max, <math>t\theta</math>step settings are the same as Initial Default.</li> </ul>
Standard	Both $x$ scale and $y$ scale are set to 1. Both the $x$ -axis and $y$ -axis directions are displayed in the range of $-10$ ( $x$ min, $y$ min) to $10$ ( $x$ max, $y$ max).
Picture	View Window settings that maintain the current background image are applied.
Auto	View Window settings are automatically optimized for the expression (the last expression selected in the case of multiple expressions) selected for graphing on the Graph Editor window.

\* These values are displayed as decimal format values.



### View Window parameter precautions

- When the View Window setting produces an axis that does not fit on the display, the scale of the axis is indicated on the edge of the display closest to the origin.
- Changing the  $x$ min ( $y$ min) or  $x$ max ( $y$ max) value automatically changes the  $x$ dot ( $y$ dot) value, while changing the  $x$ dot ( $y$ dot) value automatically changes the  $x$ max ( $y$ max) value.



## Using View Window Memory

You can save your View Window setup for later use.

### • To save the current View Window setup

1. Tap , or tap  and then [View Window] to display the View Window dialog box.
2. Change parameters as required (see “To configure View Window parameters” on page 102).
3. Tap [File] and then [Save File]. This displays a dialog box for inputting a name for the View Window setup.
4. Enter the name and then tap [OK].

### • To recall a setup from View Window memory

1. Tap , or tap  and then [View Window] to display the View Window dialog box.
2. Tap [File] and then [Open File]. This displays a list of names of View Window setups stored in ClassPad memory.
3. Select the name of the setup you want, and then tap [OK].
  - This causes the current View Window parameters to be replaced by the parameters of the recalled setup.

## Panning the Graph Window

You can drag the Graph window screen to scroll (pan) its contents.

### • ClassPad Operation

1. Holding the stylus anywhere against the Graph window, drag it in the direction you want.
  - This causes the Graph window to scroll automatically in accordance with the dragging.
2. When the Graph window shows the area you want, remove the stylus from the display.
  - This causes the graph to be redrawn on the Graph window.



### Tip

- Graph window panning cannot be performed while any one of the following functions is being used: Modify, Trace, Sketch, G-Solve, box zoom.
- While a panning operation is in progress on the Graph window, the coordinates of the point where the stylus is held against the display is displayed in the status bar.

---

## Scrolling the Graph Window

You can use either of the two operations to scroll the Graph window up, down, left, or right.

- Tapping the graph controller arrows at the edges of the Graph window.
- Using the cursor key.

Display of the graph controller arrows is turned off under initial default settings. Use the Graph Format dialog box to turn them on, if you want. For more information, see “Graph Format Dialog Box” on page 38.

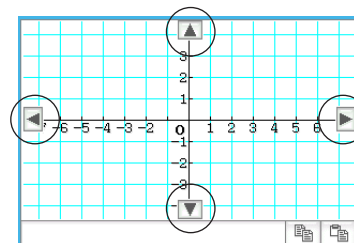



Graph controller arrows

---

## Zooming the Graph Window

You can zoom in on the Graph window image by holding two fingers against the screen while moving them apart from each other. Moving two fingers closer to each other in a pinching action will zoom out. Your ClassPad also provides you with a wide selection of zoom commands that you can use to enlarge or reduce an entire graph or a specific area of a graph.

To perform this type of zoom:	Do this:
To enlarge the area enclosed in a boundary	<ol style="list-style-type: none"><li>1. Tap [Zoom] and then [Box], or tap .</li><li>2. On the Graph window, drag the stylus to draw a selection boundary around the area you want to enlarge.</li><li>3. Remove the stylus from the display.<ul style="list-style-type: none"><li>• The area within the selection boundary will expand to fill the entire Graph window.</li></ul></li></ol>
To enlarge or reduce to a specified numeric factor	<ol style="list-style-type: none"><li>1. Tap [Zoom] and then [Factor].</li><li>2. On the dialog box that appears, input the <math>x</math>- and <math>y</math>-axis zoom factor, and then tap [OK].</li><li>3. Tap [Zoom] - [Zoom In] to enlarge to the specified factor, or [Zoom] - [Zoom Out] to reduce.</li></ol>

To do this on the Graph window:	Do this:
Automatically configure settings so the Graph screen fills the entire screen in accordance with the graph being drawn	Tap [Zoom] and then [Auto], or tap  .
Return a graph to its original View Window settings	Tap [Zoom] and then [Original].
Adjust View Window $x$ -axis values so that they are identical to the $y$ -axis values	Tap [Zoom] and then [Square].
Round View Window settings ( $x_{min}$ , $x_{max}$ , $x_{dot}$ ) to an appropriate number of decimal places and redraw the graph	Tap [Zoom] and then [Round].
Make the value of each dot equal 1, which makes all coordinate values integers	Tap [Zoom] and then [Integer].
Return View Window parameters to their settings prior to the last zoom operation	Tap [Zoom] and then [Previous].
Return View Window parameters to their initial default (see “Initial (Default)” under “View Window Preset Parameters” on page 103)	Tap [Zoom] and then [Initialize].
Redraw graphs using preset View Window parameter values	See “Using Quick Zoom” below.

---

## Using Quick Zoom

The quick zoom commands on the [Zoom] menu draw a graph using preset built-in View Window parameter values.

### Note

- The values in the explanations below apply during the vertical half-size view of the Graph window (which is the initial default setting of the Graph & Table application). Tapping  on the icon panel will switch to the full-screen view and change the View Window settings.
- The View Window settings will differ from those shown below when the Graph window is displayed using the horizontal view.

Command	View Window Parameter Values*1					
	xmin	xmax	xscale	ymin	ymax	yscale
Quick Trig	*2	*2	*2	-2.1	2.1	1
Quick log ( $x$ )	-2	13.4	2	-4.6	4.6	1
Quick $e^x$	-2.2	2.2	1	-1.4	9	1
Quick $x^2$	-7.7	7.7	2	-12	80	5
Quick $-x^2$	-7.7	7.7	2	-80	12	5
Quick Standard	-10	10	1	-10	10	1

\*1 Any View Window parameter that is not shown in the above table is unchanged when you execute a quick zoom command.

\*2 Depending on the Basic Format Angle setting, executing Quick Trig changes the xscale setting to  $\pi/2$  (for Radian), 90 (for Degree), or 100 (for Grad). The following settings are applied based on the xscale value:  
 $xmin = -7.7 \times xscale$ ,  $xmax = 7.7 \times xscale$ .

---

## Using Built-in Functions for Graphing

Your ClassPad is pre-programmed with the commonly used functions listed below.

$$y = a \cdot x + b$$

$$y = a \cdot \cos(b \cdot x + c) + d$$

$$y = a \cdot e^{(b \cdot x + c)} + d$$

$$y = a \cdot x^2 + b \cdot x + c$$

$$y = a \cdot \tan(b \cdot x + c) + d$$

$$y = a^{(b \cdot x + c)} + d$$

$$y = a \cdot x^3 + b \cdot x^2 + c \cdot x + d$$

$$y = a \cdot \log(b \cdot x + c) + d$$

$$y = a / (b \cdot x + c) + d$$

$$y = a \cdot \sin(b \cdot x + c) + d$$

$$y = a \cdot \ln(b \cdot x + c) + d$$

You can recall a built-in function and register it as-is into the Graph Editor window. You can then replace the parameters in the function with values and graph the results, or you can leave the literal parameter names unchanged and use Dynamic Modify (page 115) to modify the form of the graph.

### • ClassPad Operation

1. Tap [Type] - [y=Type].
2. On the Graph Editor window, tap  and then [Built-In].
3. On the menu that appears, tap the built-in function you want to select.
  - The selected built-in function is input as-is on the Graph Editor window. Input values for each parameter as required.
  - You can leave some or all of the literal parameter names unchanged and use Dynamic Modify (page 115) to modify the form of the graph.

---

## Saving a Screenshot of a Graph

Use the following procedures to save a screenshot of a graph as image data for later recall.

### • To open a screenshot of a graph

1. On the Graph window, tap  and then [Open Picture]. This displays a list of names of graph images you have stored in memory.
2. Select the name of the image you want, and then tap [OK].
  - The image you select is displayed as the Graph window background.

### • To save a screenshot of a graph

1. Draw the graph you want to save.
2. Tap  and then [Save Picture]. This displays a dialog box for inputting a name for the screenshot.
3. Enter the name and then tap [OK].

### • To clear the current screenshot of a graph





On the Graph window, tap  and then [Clear Picture].

---

## Adjusting the Lightness (Fade I/O) of the Graph Window Background Image

You can adjust the lightness of the graph window background image within a range of 0% (as-is) to 100% (all white). A higher setting value makes the image lighter, and a setting of 100% displays an all white background. You can use this setting to adjust the background image to a level that makes the graph easier to see.

### • To adjust the lightness (Fade I/O) of the graph window background image

1. On the Graph window, tap  and then [Fade I/O].
  - This causes a slider for adjusting image lightness to appear on the toolbar.
2. Use  and  to adjust the lightness value.
  - Each press of  and  changes the setting value in steps of 5%.
3. After the setting is the way you want, tap [OK].

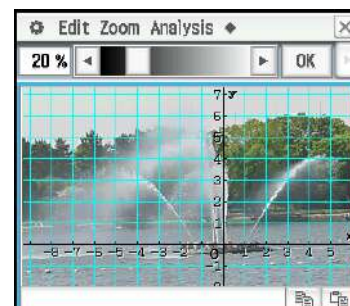

### 3-3 Using Table & Graph

The Graph & Table application includes a “Table window” for displaying number tables and summary tables generated with the functions you input on the Graph Editor window.

#### Generating a Number Table

A number table can be created for one or more  $y=$ Type,  $r=$ Type, or ParamType (Parametric Type) functions registered on the Graph Editor window.

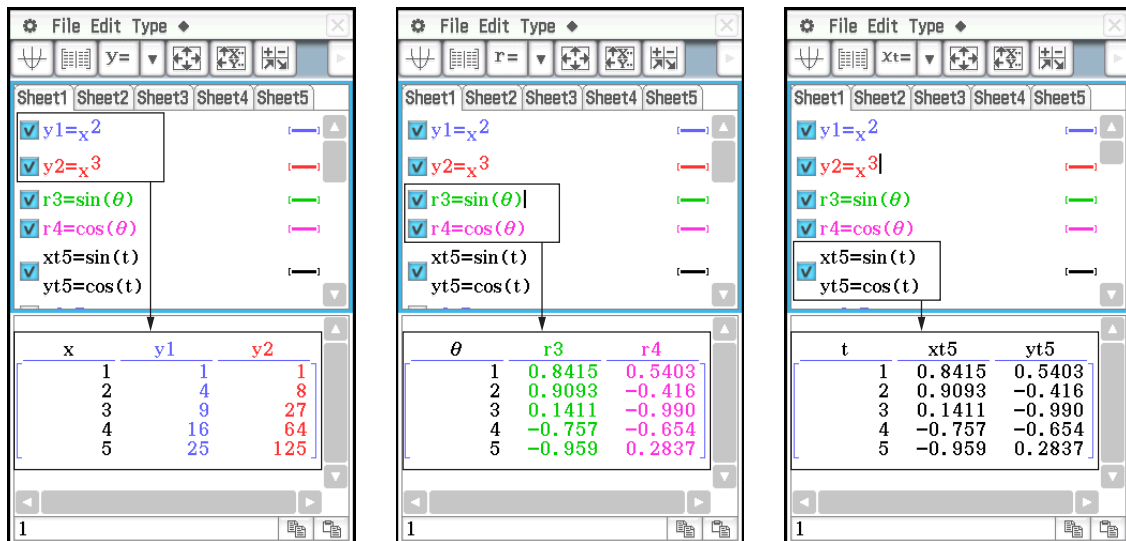

$y=$ Type:  $(x, y)$  number table

$r=$ Type:  $(\theta, r)$  number table

ParamType:  $(t, xt, yt)$  number table

The following are the two methods that can be used to create a number table using the Graph & Table application.

- Specifying the value range of  $x$ ,  $\theta$ , or  $t$  using the Table Input dialog box
- Specifying the value range of  $x$ ,  $\theta$ , or  $t$  using a list stored in ClassPad memory

#### Tip

- The derivative is also included in the number table when the Graph Format “Derivative/Slope” check box is selected.
- You can specify the width of table cells using the [Cell Width Pattern] on the Graph Format dialog box (page 38).

x	y1	y'1
1	1	2.0000
2	4	4.0000
3	9	6.0000
4	16	8.0000
5	25	10.000

#### • To generate a number table by specifying a range of values for $x$ , $\theta$ , or $t$ using the Table Input dialog box

1. On the Graph Editor window, input the function(s) you want to use for number table creation, and select the check box(es) to the left of the function(s) you want to use.
2. Tap the [Type] menu, and then select the type ([ $y=$ Type], [ $r=$ Type], or [ParamType]) of the function(s) you want to use for number table creation.
3. Tap to display the Table Input dialog box.
4. Input the values for the  $x$ -,  $\theta$ -, or  $t$ -values of your table, and then tap [OK].
5. Tap to generate the number table and display it on the Table window.

**Tip:** The above operation is possible only when “Table Input” (which is the initial default) is selected for the Graph Format dialog box [Table Variable] item.

• **To generate a number table by assigning list values to  $x$ ,  $\theta$ , or  $t$**

1. Tap and then [Graph Format] to display the Graph Format dialog box.
2. Tap [Special] tab, and then select a list option (list1 through list6 or a list variable created by you) for the [Table Variable] item.
  - By way of example, here we will select “list1”.
3. Tap [Set] to apply the settings and close the dialog box.
4. Tap , [Window] and then [Stat Editor] to display the Stat Editor window.
5. In the list you selected in step 2 (list1 in this example), input the values you want to assign to  $x$ ,  $\theta$ , or  $t$ .
  - For information about Stat Editor window operations, see Chapter 7.
6. On the Graph Editor window, input the function(s) you want to use for number table creation, and select the check box(es) to the left of the function(s) you want to use.
7. Tap the [Type] menu, and then select the type ([ $y$ =Type], [ $r$ =Type], or [ParamType]) of the function(s) you want to use for number table creation.
8. Tap to generate the number table and display it on the Table window.

	list1	list2	list3
1	-3		
2	-1		
3	0		
4	1		
5	3		
6			

Cal▶

[ 5]= 3

• **To draw a graph using a number table**

Perform either of the operations below.

Tap [Graph] - [G-Plot] or tap .

- This will draw a graph that plots the coordinates in the number table.

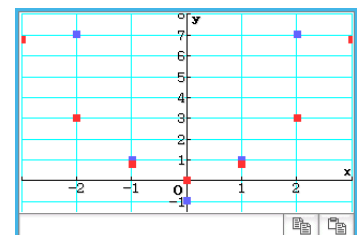

Tap [Graph] - [G-Connect] or .

- This graphs the expression used to create the number table and plots the coordinates in the table.

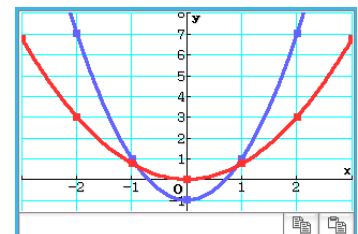

• **To save a number table to a list**

1. On the Table window, select any cell in the column you want to save to a LIST variable.
  - To save column  $y_1$ , for example, select any cell in column  $y_1$ .
2. Tap and then [Table to List].
  - This displays a dialog box for specifying a variable name.
3. Enter the name you want to give to the variable, and then tap [OK].
  - This assigns the list of data you selected to a variable with the name you specified.

**Showing Linked Displays of Number Table Coordinates and Graph Coordinates (Link Trace)**

With Link Trace, selecting a value in a number table created using a function causes a crosshair pointer (trace pointer) to appear at the corresponding coordinates on the graph.

**0302** To create a number table of  $y = 3\log(x+5)$ , graph the values, and perform link trace

---

## Generating Number Table Values from a Graph

You can input the coordinate values where the pointer is currently located on a graph into a table by simply pressing **[EXE]**.

**0303** To generate number table values from the  $y = x^3 - 3x$  graph

---

## Generating a Summary Table

A summary table can be created from a  $y=$ Type function registered on the Graph Editor window. The figure below shows an example of the summary graph and table of  $y = x^3 - 3x$ .

The following are the two methods that can be used to create a summary table using the Graph & Table application.

- **Creating a summary table with the View Window settings  $x_{min}$  as the lower limit value and  $x_{max}$  as upper limit value**

With this method, the  $x$  within the range of  $x_{min}$  and  $x_{max}$  where  $f'(x) = 0$  is automatically calculated and added to the table. You can specify  $x_{min}$  and  $x_{max}$  values, or you can use auto settings ([Memory] - [Auto] View Window settings).

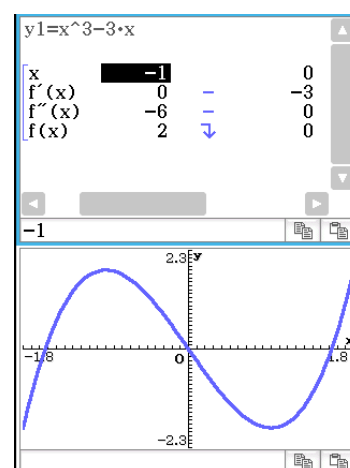

- **Specifying the range of  $x$ -values for creating a summary table using a list stored in ClassPad memory**



This method generates a summary table by looking up data stored in a list. A LIST variable is used to specify the  $x$ -values. When using this method, it is up to you specify all of the correct  $x$ -values required to generate the summary table. The summary table will not be generated correctly if you provide incorrect  $x$ -values.

### Tip

- You can control whether or not the summary table should include an  $f''(x)$  line (second derivative component) using the [Summary Table  $f''(x)$ ] setting on the [Special] tab of the Graph Format dialog box (page 38). Turning on the [Summary Table  $f''(x)$ ] option causes both first derivative components and second derivative components to be displayed in the summary table. Turning it off shows first derivative components only.
- Some functions may not be solvable by the ClassPad's internal summary table calculation. When this happens, the "Can't Solve!" error message appears on the display.

- **To generate a summary table using View Window**



1. On the Graph Editor window, register the function you want to use to create the summary table.
  - Make sure that only the check box of the function to be used for summary table creation is selected. Clear the check boxes of all other functions on the Graph Editor window.
2. Tap **[F5]** to display the View Window dialog box.
3. Perform any one of the operations below.
  - Tap [Memory] and then [Auto]. This causes all settings on the View Window dialog box to change to "Auto".
  - Specify the  $x$ -values for the summary table by specifying values for the [ $x_{min}$ ] and [ $x_{max}$ ] settings.

4. Tap [OK] to close the View Window dialog box.
  - Tapping  here graphs the function using the View Window settings.
5. Tap .
  - This starts summary table generation, and displays the result on the Table window. Note that generation of a summary table can take a bit of time.

**Tip**

- The above operation is possible only when “View Window” (which is the initial default) is selected for the Graph Format dialog box [Summary Table] item.
- A monotone increasing function or other special function may not be solvable by the ClassPad’s internal summary table calculation. If this happens, use the procedure below.

• **To generate a summary table by specifying all of the values for  $x$**

1. Tap  and then [Graph Format] to display the Graph Format dialog box.
2. Tap the [Special] tab, and then select a list option (list1 through list6 or a list variable created by you) for the [Summary Table] item.
  - By way of example, here we will select “list1”.
3. Tap [Set] to apply the settings and close the dialog box.
4. Tap , [Window] and then [Stat Editor] to display the Stat Editor window.
5. In the list you selected in step 2 (list1 in this example), input the values you want to assign to  $x$ .
6. Tap the Graph Editor window to make it active.
7. On the Graph Editor window, register the function you want to use to create the summary table.
  - Make sure that only the check box of the function to be used for summary table creation is selected. Clear the check boxes of all other functions on the Graph Editor window.
8. Tap .
  - This starts summary table generation using the  $x$ -values you input in step 5, and displays the result on the Table window.

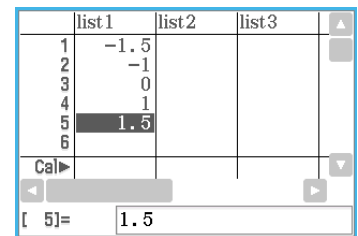

	list1	list2	list3
1	-1.5		
2	-1		
3	0		
4	1		
5	1.5		
6	6		

Cal▶ [ 5]= 1.5

## 3-4 Using Trace

Trace lets you move a point along a graph and displays the coordinates for the current pointer location. You can also link the trace operation to the number table used to draw a graph, so the pointer jumps to the coordinates that are currently selected in the table.

---

### Using Trace to Read Graph Coordinates

Starting the trace operation causes a crosshair pointer to appear on the graph. You can then press the cursor key or tap the graph controller arrows to move the pointer. The coordinates are displayed as you move the pointer.

• **To perform a trace operation**

1. On the Graph Editor window, input and store a function, and then tap  to graph it.
  - Here, input  $y = x^2 - 3$  into line y1.

2. Tap [Analysis], [Trace], or tap  $\boxed{\Delta y}$ .
  - This will display the pointer at the coordinates where  $x = 0$ . The pointer will not be visible when it is located at a point outside the graph display area.
  - If “Undefined” appears in place of the  $x_c$  or  $y_c$  coordinate, it means that the current point is undefined. Press the left or right cursor key to move to a point that is defined.
3. Press the left or right cursor key, or tap the left or right graph controller arrow.
  - This moves the pointer along the graph, and displays the coordinates of the current pointer location.
  - You can also move the pointer to a particular point by inputting coordinates. Pressing a number key displays a dialog box for inputting coordinates. Input the values you want and then tap [OK].
  - When there are multiple graphs on the Graph window, you can use the up and down cursor keys or the up and down graph controller arrows to move the pointer between graphs.
4. To quit the trace operation, tap  $\overset{\text{Esc}}{\leftarrow}$  on the icon panel.

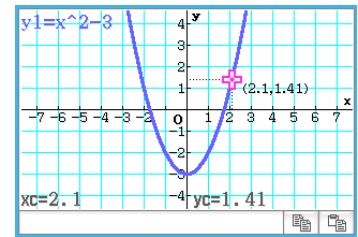

### Tip

- While the trace pointer is on the window, tapping the displayed coordinate values causes the coordinate values to appear in the message box. You can then copy the coordinates to the clipboard.
- Selecting the [Derivative/Slope] check box on the Graph Format Dialog Box will show the derivative along with coordinates while the trace pointer is on the display. Clearing the [Coordinates] check box will hide the coordinate display while the trace pointer is on the display. For more information, see “Graph Format Dialog Box” on page 38.

## 3-5 Using the Sketch Menu

The [Sketch] menu lets you add points, lines, figures, and text after you draw a graph. You can also add tangent and normal lines to your graph.

---

### Using Sketch Menu Commands

This section describes how to use each of the commands on the [Sketch] menu.

#### • To clear figures inserted using the Sketch menu

To clear plots, lines, text, or other figures inserted using the [Sketch] menu, tap [Analysis], [Sketch], and then [CIs]. This redraws the graph to what is stored on the Graph Editor window.

#### • To plot a point on the Graph window

1. While the Graph window is active, tap [Analysis], [Sketch], and then [Plot].
2. Tap the location on the Graph window where you want to plot a point.
  - Instead of tapping the Graph window, you could also use the keypad to specify the coordinates of the point. Press a number key on the keypad. On the dialog box that appears, input  $x$ - and  $y$ -coordinate values, and then tap [OK].

#### • To draw a line on the Graph window

1. While the Graph window is active, tap [Analysis], [Sketch], and then [Line].
2. Tap the start point of the line and then tap the end point. This causes a straight line to be drawn between the two points. The message box shows the equation of the line.
  - Instead of tapping the Graph window, you can use the keypad to specify the coordinates of the start point and end point. Press a number key on the keypad. On the dialog box that appears, input the coordinates for the start point  $(x_1, y_1)$  and the end point  $(x_2, y_2)$ , and then tap [OK].



• **To write text on the Graph window**

1. While the Graph window is active, tap [Analysis], [Sketch], and then [Text].
2. On the dialog box that appears, enter the text you want and then tap [OK].
  - This displays the word “Text” in the lower right corner of the Graph window.
3. Place the stylus on the screen and hold it there.
  - This causes the text you input in step 2 to appear at the location where you are pointing with the stylus.
4. Drag the text to the location you want, and then lift the stylus from the screen.

**Tip:** You cannot edit text after inputting it into the Graph window.

• **To draw a line tangent to a graph**

1. On the Graph Editor window, register the function you want to graph.
  - By way of example, here we will register the following function:  $y = x^2 - x - 2$ .
2. Tap  $\Psi$  to draw the graph. Next, tap [Analysis], [Sketch], and then [Tangent].
  - This displays the crosshair pointer along with its corresponding coordinate values.
3. Press  $\boxed{1}$ .
4. The  $x$ -value specification dialog box will have  $x = 1$  input, so tap [OK].
  - This draws the tangent to  $y = x^2 - x - 2$  at  $x = 1$ .

**Tip:** Instead of inputting coordinate values in steps 3 and 4, you can use the cursor key or the graph controller arrows to move the pointer to the point of tangency on the Graph window.

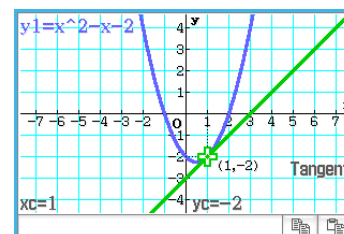

• **To draw a line that is normal to a graph**

The procedure for drawing a line that is normal to a graph is virtually identical to the procedure “To draw a line tangent to a graph”, above. The only difference is in step 2, where you need to tap [Analysis], [Sketch], and then [Normal] instead of [Tangent].

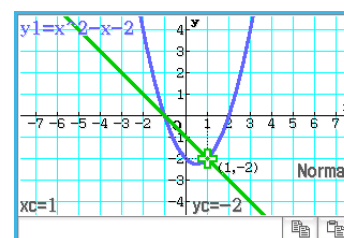

• **To graph the inverse of a function**

**0304** To graph  $y = x^2 - x - 2$  and then overlay it with  $x = y^2 - y - 2$

• **To draw a circle**

**0305** To draw a circle

• **To draw a vertical or horizontal line**



**0306** To draw a vertical line at  $x = 2$

## 3-6 Analyzing a Function Used to Draw a Graph

Your ClassPad includes a G-Solve feature that lets you perform a variety of different analytical processes on an existing graph.

### What You Can Do Using the G-Solve Menu Commands

While there is a graph on the Graph window, you can use a [G-Solve] menu command to obtain the following information.

- $x$ -coordinate for a given  $y$ -coordinate..... Analysis - G-Solve -  $x$ -Cal/ $y$ -Cal -  $x$ -Cal
- $y$ -coordinate for a given  $x$ -coordinate..... Analysis - G-Solve -  $x$ -Cal/ $y$ -Cal -  $y$ -Cal
- Root (the  $x$ -intercept) ..... Analysis - G-Solve - Root or 
- Minimum value..... Analysis - G-Solve - Min or 
- Maximum value..... Analysis - G-Solve - Max or 
- Minimum value in the range displayed on the Graph window..... Analysis - G-Solve -  $f$  Min
- Maximum value in the range displayed on the Graph window..... Analysis - G-Solve -  $f$  Max
- $y$ -intercept ..... Analysis - G-Solve -  $y$ -Intercept
- Point of intersection for two graphs..... Analysis - G-Solve - Intersection
- Integration value for a specified range..... Analysis - G-Solve - Integral -  $\int dx$
- Integration value between the two or more of the graph's roots ..... Analysis - G-Solve - Integral - Root
- Integration value between the two or more intersections of two graphs ..... Analysis - G-Solve - Integral - Intersection
- Point of inflection..... Analysis - G-Solve - Inflection
- Distance between two points ..... Analysis - G-Solve - Distance
- Volume of a solid of revolution..... Analysis - G-Solve -  $\pi \int f(x)^2 dx$

**Tip:** See “Graph Types and Executable Functions” (page 302) for information about graph types and executable G-Solve functions.

### Using G-Solve Menu Commands

When multiple solutions are obtained by a G-Solve command, only one solution is displayed at a time. For example, executing [Analysis] - [G-Solve] - [Root] for a cubic function that has two roots will display only one root at a time. In a case such as this, use the left and right cursor keys (or tap the left and right graph controller arrows) to cycle between the available solutions.

#### • To obtain the root of a function

1. On the Graph Editor window, input and store a function, and then tap  to graph it.

- Here, input  $y = x(x + 2)(x - 2)$  into line  $y1$ .

2. Tap [Analysis], [G-Solve], and then [Root], or tap .

- This displays “Root” on the Graph window, and locates a pointer at the first solution of the root (root for smallest value of  $x$ ). The  $x$ - and  $y$ -coordinates at the current pointer location are also shown on the Graph window.

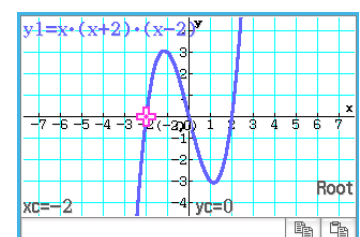

3. To obtain other roots, press the left or right cursor key, or tap the left or right graph controller arrows.
- If there is only one solution, the pointer does not move when you press the cursor key or tap the graph controller arrow.

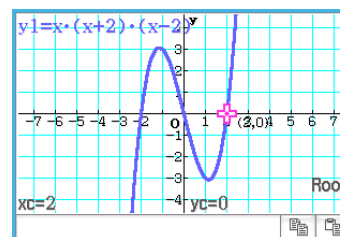
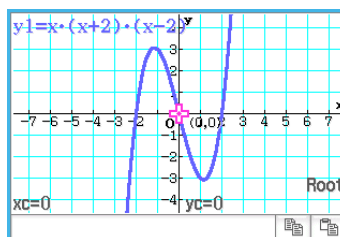

The following are examples for other G-Solve commands.

- 0307** To obtain the point of intersection for two graphs  $y = x + 1$  and  $y = x^2$
- 0308** To determine coordinates at a particular point on a graph
- 0309** To graph the function  $y = x(x + 2)(x - 2)$  and obtain its definite integral in the domain of  $1 \leq x \leq 2$
- 0310** To graph the function  $y = x^3 - 1$  and determine its inflection point
- 0311** To graph the function  $y = x^2 - x - 2$  and obtain the volume of a solid of revolution as the line segment from  $x = 1$  to  $x = 2$  is rotated on the  $x$ -axis

## 3-7 Modifying a Graph

A graph can be modified in real time as you change its parameters and/or variable values. The Graph & Table application provides you with two methods for modifying a graph - “Direct Modify” and “Dynamic Modify”.

### Modifying a Single Graph (Direct Modify)

“Direct Modify” changes the parameter in the equation of the original graph. This method can be used when you are modifying a single graph.

- 0312** To graph the functions  $y = 2x^2 + 3x - 1$  and  $y = 2x + 1$ , and then find out how a change in the parameters of each function affects the shape and position of the graphs

### Modifying Multiple Graphs Simultaneously (Dynamic Modify)

“Dynamic Modify” changes the values assigned to common parameters of multiple functions. Use Dynamic Modify when you want to modify multiple graphs at the same time.

#### • Inputting a Graph Formula for Use with Dynamic Modify

**Example:** To input the following formula with two common parameters ( $a$ ,  $b$ ):

$$y = ax^2 - bx \text{ and } y = ax + b$$

1. On the Graph Editor window, tap [Type] - [ $y=$ Type].
2. Perform any one of the operations below.
  - Input using built-in functions
  - (1) Tap  $\blacklozenge$  - [Built-In] - [ $y = a \cdot x^2 + b \cdot x + c$ ] to input  $y = ax^2 + bx + c$ .
  - (2) Edit the function you input ( $y = ax^2 + bx + c$ ) to it becomes  $y = ax^2 - bx$ , and then press **[EXE]**.
  - (3) Tap the line below the function.
  - (4) Tap  $\blacklozenge$  - [Built-In] - [ $y = a \cdot x + b$ ] to input  $y = ax + b$  and then press **[EXE]**.

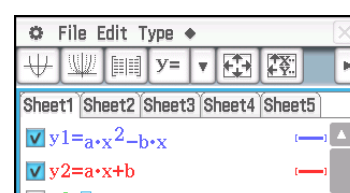

- Input using the soft keyboard and keyboard

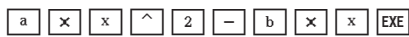

(1) Display the soft keyboard and use it to perform the key operation below.



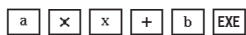



(2) Tap the line below the formula you input and then perform the key operation below.

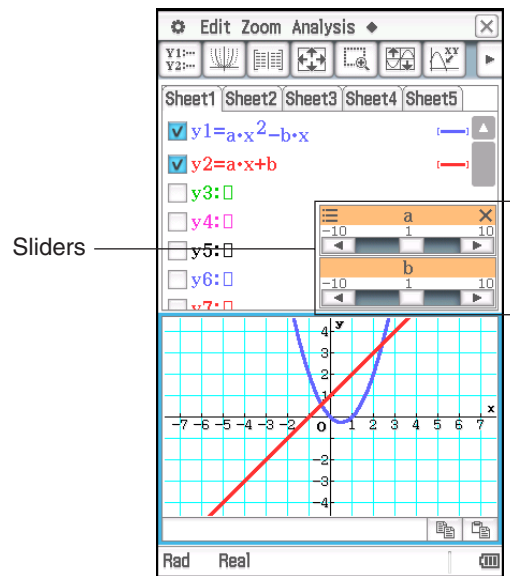

### • To run Dynamic Modify

- On the Graph Editor window, input at least one formula that contains a parameter.
- Select the check box next to the graph formula(s) you want to use with Dynamic Modify and clear the check boxes of all of the other graphs.
  - In the explanation below, there are two formulas registered on the Graph Editor window:  $y = ax^2 - bx$  and  $y = ax + b$ . The check boxes of both of these formulas are selected for use with Dynamic Modify.
- To run Dynamic Modify, tap  and then [Dynamic Graph] or tap .
  - This will display sliders for changing values assigned to parameters  $a$  and  $b$ .
- Tap the arrow buttons at either end of the  $a$  and  $b$  sliders.
  - Each tap will change the values assigned to the applicable parameter ( $a$  or  $b$ ) and redraw the graph accordingly.
  - The operations described below are supported while Dynamic Modify is running.



To do this:	Do this:
Change the current value, minimum value, maximum value and step value.	<ol style="list-style-type: none"> <li>Tap the upper left corner of the slider display box. On the menu that appears, tap [Settings].                             <ul style="list-style-type: none"> <li>This displays the Slider Settings dialog box. The number of tabs on the dialog box will match the number of parameters in your graph formula(s).</li> </ul> </li> <li>Use the tabs to specify the current value, minimum value, maximum value, and step value for each of the parameters.</li> <li>To close the dialog box and save your changes, tap [OK].</li> </ol>
Automatically modify the form of a graph (by changing the value of a specific parameter between specified minimum and maximum values)	<ol style="list-style-type: none"> <li>Tap the upper left corner of the slider display box.</li> <li>On the menu that appears, tap [Auto Play].                             <ul style="list-style-type: none"> <li>This starts an operation that automatically changes the value of the applicable parameter between the minimum value and maximum value, and then from the maximum value back to the minimum value. This cycle will stop automatically after a few cycles from the minimum value to the maximum value are complete. To stop a cycle part way through, tap  on the icon panel or press . (Simultaneous Auto Play execution for multiple parameters is not supported.)</li> </ul> </li> </ol>
Temporarily hide sliders	<ol style="list-style-type: none"> <li>Tap the upper left corner of the slider display box. On the menu that appears, tap [Minimize].                             <ul style="list-style-type: none"> <li>This hides all currently displayed sliders and causes the slider icon () to appear in the status bar.</li> </ul> </li> <li>To unhide the sliders, tap the slider icon () in the status bar.</li> </ol>

### • To exit Dynamic Modify

Tap the close button () in the upper right corner of the slider display box.

#### **Note**

- While Dynamic Modify is running, up to three sliders can be displayed for the parameters included in the graph formulas whose check boxes are selected. If there are more than three parameters in the selected graph formulas, the three parameters are automatically assigned to sliders in accordance with the rules below.
  - In the case of one graph formula, parameters are assigned to sliders from left to right until three are assigned.
  - In the case of multiple graph formulas, parameters are assigned to sliders in the chronological order that the graph formulas were registered (from left to right in each formula) until three are assigned.
- To change slider allocations from those applied automatically, perform the steps below.
  1. Tap the upper left corner of the slider display box.
  2. On the menu that appears, tap [Settings].
  3. On the Slider Settings dialog box that appears, tap the “Parameter” line button.
  4. On the parameter list that appears, tap the parameter you want to assign to the slider.
- If you use the above procedure to assign a different parameter to a slider, the parameter that was previously assigned to the slider will retain the value it was set at when you changed the slider assignment. Also, the minimum value, maximum value and step value will automatically change in accordance with the parameter value. The automatically generated values will be applied if you later assign the parameter to a slider.

**0313** To graph the functions  $y = ax^2 - bx$  and  $y = ax + b$ , and then find out how a change in parameter  $a$  from 1 to 4 and a change in parameter  $b$  from  $-2$  to 2 affect the shape and position of each graph

# Chapter 4: Conics Application

The Conics application provides you with the capability to graph circular, parabolic, elliptic, and hyperbolic functions. You can also use the Conics application to quickly and easily determine the proper focal point, vertex, directrix, and other information about each type of conics.

Starting up the Conics application displays two windows: ① the Conics Editor window and ② the Conics Graph window.

A function input on the Conics Editor window is graphed on the Conics Graph window.

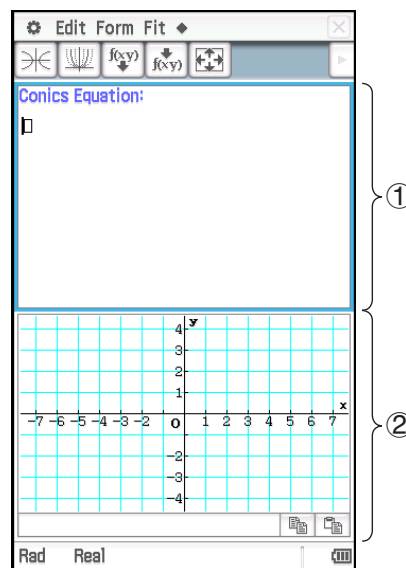

## Conics Application-Specific Menus and Buttons

### Conics Editor window

- Draw a graph ..... 
- Start modifying a graph (Dynamic Modify, page 121) ..... 
- Insert a Conics Form.....Form - Insert Conics Form or 
- Adjust the equation so it fits a Conics Form.....Fit - Fit into Conics Form or 

### Conics Graph window

- Make the Conics Editor window active ..... 
- Perform a G-Solve operation (page 120)..... Analysis - G-Solve

**Tip:** The Conics application uses many of the same commands (Zoom, Trace, Sketch, etc.) as the Graph & Table application.

## 4-1 Inputting an Equation

You can select one of the preset Conics Forms or input a conics equation manually. You can also transform a manually input equation to a Conics Form.

### • To input an equation using a Conics Form

1. On the Conics Editor window, tap  to displays the Select Conics Form dialog box.
2. Select the Conics Form of the type of equation you want to graph, and then tap [OK].
  - This displays the Conics Editor window, which will contain the selected Conics Form.
3. Change the parameters of the equation as required.

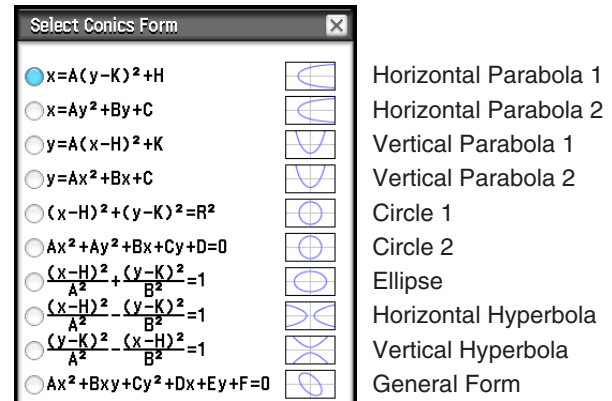

**0401** To use a Conics Form to input the equation for a parabola with a horizontal axis (principal axis parallel with  $x$ -axis)

### • To input an equation manually

Make the Conics Editor window active, and then use the soft keyboard for input.

### • To transform a manually input equation to a Conics Form

**0402** To transform the equation  $\frac{(x-1)^2}{2^2} + (y-2)^2 = \frac{x^2}{4}$  to the standard Conics Form  $x = Ay^2 + By + C$

#### Tip

- If the equation you input cannot be transformed into the standard Conics Form you selected, the message “Can’t Transform into This Type” appears.
- An input equation may not transform correctly if it includes a square root calculation or some other function.

## 4-2 Drawing a Conics Graph

**Tip:** You can drag the Conics Graph window screen to scroll (pan) its contents (except for Trace, Sketch, G-Solve, box zoom, and certain other functions).

### Drawing a Parabola

A parabola can be drawn with either a horizontal or vertical orientation. The parabola type is determined by the direction of its principal axis.

- A parabola with a horizontal axis is one whose principal axis is parallel to the  $x$ -axis. There are two possible equations for a parabola with a horizontal axis:  
 $x = A(y - K)^2 + H$  and  $x = Ay^2 + By + C$ .

**0401** To draw the parabola  $x = 2(y - 1)^2 - 2$

- A parabola with a vertical axis is one whose principal axis is parallel to the  $y$ -axis. There are two possible equations for a parabola with a vertical axis:  
 $y = A(x - H)^2 + K$  and  $y = Ax^2 + Bx + C$ .

---

## Drawing a Circle

There are two forms that you can use to draw a circle.

- One form is the standard form, which allows you to specify the center point and radius:  
 $(x - H)^2 + (y - K)^2 = R^2$
- The other form is the general form, which allows you to specify the parameters of each term:  
 $Ax^2 + Ay^2 + Bx + Cy + D = 0$

---

## Drawing an Ellipse

You can use the standard equation  $\frac{(x - H)^2}{A^2} + \frac{(y - K)^2}{B^2} = 1$  to draw an ellipse.

---

## Drawing a Hyperbola

A hyperbola can be drawn with either a horizontal or vertical orientation. The hyperbola type is determined by the direction of its principal axis.

- The standard form of a hyperbola with a horizontal axis is:  $\frac{(x - H)^2}{A^2} - \frac{(y - K)^2}{B^2} = 1$
- The standard form of a hyperbola with a vertical axis is:  $\frac{(y - K)^2}{A^2} - \frac{(x - H)^2}{B^2} = 1$

---

## Drawing a General Conics

Using the conics general equation  $Ax^2 + Bxy + Cy^2 + Dx + Ey + F = 0$ , you can draw a parabola or hyperbola whose principal axis is not parallel either to the  $x$ -axis or the  $y$ -axis, a slanted ellipse, etc.

# 4-3 Using G-Solve to Analyze a Conics Graph

---

## What You Can Do Using the G-Solve Menu Commands

While there is a graph on the Conics Graph window, you can use a command on the [Analysis] - [G-Solve] menu to obtain the following information.

- $x$ -coordinate for a given  $y$ -coordinate..... G-Solve -  $x$ -Cal/ $y$ -Cal -  $x$ -Cal
- $y$ -coordinate for a given  $x$ -coordinate..... G-Solve -  $x$ -Cal/ $y$ -Cal -  $y$ -Cal
- Focus of a parabola, ellipse, or hyperbola ..... G-Solve - Focus
- Vertex of a parabola, ellipse, or hyperbola ..... G-Solve - Vertex
- Directrix of a parabola..... G-Solve - Directrix
- Axis of symmetry of a parabola..... G-Solve - Symmetry
- Length of the latus rectum of a parabola ..... G-Solve - Latus Rectum Length
- Center point of a circle, ellipse, or hyperbola..... G-Solve - Center
- Radius of a circle ..... G-Solve - Radius
- Asymptotes of a hyperbola ..... G-Solve - Asymptotes
- Eccentricity of a parabola, ellipse, or hyperbola ..... G-Solve - Eccentricity
- $x$ -intercept /  $y$ -intercept ..... G-Solve -  $x$ -Intercept / G-Solve -  $y$ -Intercept

**Tip:** The color of Directrix, Symmetry, Asymptotes lines drawn using G-Solve is the color specified by the Graph Format Sketch Color. For more information about Graph Format, see "Graph Format Dialog Box" (page 38).



---

## Using G-Solve Menu Commands

When multiple solutions are obtained by a G-Solve command, only one solution is displayed at a time. For example, executing [Analysis] - [G-Solve] - [Focus] for an ellipse that has two foci will display only one focus at a time. In a case such as this, use the left and right cursor keys (or tap the left and right graph controller arrows) to cycle between the available solutions.

- **To determine the focus of the parabola  $x = 2(y - 1)^2 - 2$**

1. On the Conics Editor window, input the conics equation and then tap  to graph it.

- Here, input the parabolic equation  $x = 2(y - 1)^2 - 2$ .

2. Tap [Analysis] and then [G-Solve]. Next, on the submenu that appears, select the command you want. To determine the focus for this example, select [Focus].

- Press the left and right cursor keys to toggle the display between the two foci.

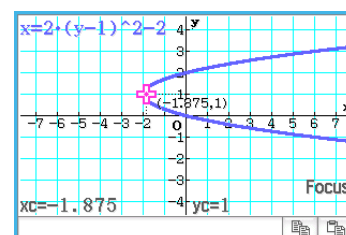

The following are examples for other G-Solve commands.

**0403** To determine the axis of symmetry of the parabola  $x = 2(y - 1)^2 - 2$

**0404** To determine the center point of the circle  $x^2 + y^2 + 4x - 6y + 9 = 0$

**0405** To determine the radius of the circle  $x^2 + y^2 + 4x - 6y + 9 = 0$

**0406** To determine the asymptotes of the hyperbola  $\frac{(x - 1)^2}{2^2} - \frac{(y - 2)^2}{3^2} = 1$

**0407** To determine the eccentricity of the ellipse  $\frac{(x - 1)^2}{2^2} + \frac{(y - 2)^2}{3^2} = 1$

**0408** To determine the  $x$ -intercept of the parabola  $x = 2(y - 1)^2 - 2$

## 4-4 Modifying a Graph (Dynamic Modify)

A graph can be modified in real time as you change its parameter values.

- **To modify a graph**

**0409** To observe the form and position of the graph of the parabola  $x = ay^2 + by + c$  as parameters  $a$ ,  $b$ , and  $c$  are each changed within a range of  $-2$  to  $2$

# Chapter 5: Differential Equation Graph Application

This chapter explains how to use the Differential Equation Graph application, which you can use to investigate families of solutions to ordinary differential equations.

The Differential Equation Graph application has the following two types of windows.

## ① Differential Equation Editor window

Use this window to input expressions ([DiffEq] tab) and initial conditions ([IC] tab) for graphing. You also can input  $f(x)$  type functions ([Graphs] tab).

## ② Differential Equation Graph window

This window shows the graph of the expression that you input into the Editor window.

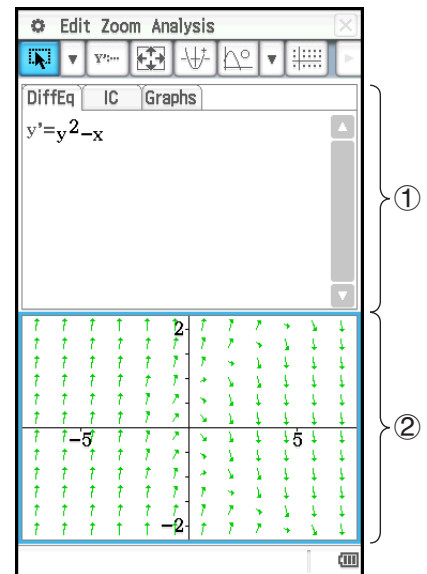

## Differential Equation Editor Window-Specific Menus and Buttons

### [DiffEq] tab, [IC] tab, [Graphs] tab

- Graph the selected function(s) .....
- Display the View Window dialog box to configure Differential Equation Graph window settings .....
- Display the Main application window .....
- Delete the line of data at the current cursor location .....

### [DiffEq] tab only

- Input a single first order differential equation ..... Type - 1st (Slope Field) or
- Input a single second order differential equation or a set of two first order differential equations ..... Type - 2nd (Phase Plane) or
- Input a higher order differential equation or a set of multiple differential equations ..... Type - Nth (No Field) or

### [Graphs] tab only









- Input  $f(x)$  type functions ..... Type -  $f(x)$  or
- Input parametric functions ..... Type - Parametric or

### [IC] tab and [Graphs] tab only

- Change graph line thickness to normal (1-dot line) or thick (2-dot line) ..... ,

## Differential Equation Graph Window-Specific Menus and Buttons

- Toggle arrows on or off to indicate the direction of slope field or phase plane vectors ..... Edit - Arrows

- Toggle the use of unit vectors on or off for slope field or phase plane graphing ..... Edit - Unit Vectors
- Display the Differential Equation Editor window [DiffEq] tab.....Edit - Editor - DiffEqGraph Editor
- Display the Differential Equation Editor window [IC] tab..... Edit - Editor - IC Editor
- Display the Differential Equation Editor window [Graphs] tab..... Edit - Editor - Graph Editor
- Clear all currently registered initial conditions (and, as a result, all solution curves) ..... Edit - Clear All
- Pan the graph window .....Analysis - Pan or 
- Select and move the initial condition point..... Analysis - Select or 
- Register the coordinates at the location you tap on the Differential Equation Graph window as the initial condition, and graph the solution curve based on that initial condition ..... Analysis - Modify or 
- Make the Differential Equation Editor window active ..... 
- Display the View Window dialog box to configure Differential Equation Graph window settings..... 
- Display a trace cursor that can be positioned on any  $x, y$  coordinate ..... 
- Display a trace cursor that can be positioned on any grid point that has a field line ..... 
- Display a trace cursor that can be positioned on any solution curve or general graph.....Analysis - Trace or 
- Turn display of axes and coordinate values on or off ..... 

## 5-1 Graphing a Differential Equation

You can use the Differential Equation Graph application to graph a first order, a second order, or an  $n$ th-order differential equation.

---

### Graphing a First Order Differential Equation

This section explains how to input a first order differential equation, draw a slope field, and graph the solution curve(s).

- A slope field is the family of solutions of a single, first order differential equation of the form  $y' = f(x, y)$ . It is a grid of solution lines where each line has the slope  $y'$  for a given grid value of  $x$  and  $y$ . It is often referred to as a “slope field” or “direction field” because only the direction of the field at any given point is known, not the magnitude.
- You can overlay, onto the slope field, solution curves of the first order differential equation input for given initial conditions on the [DiffEq] tab.

#### • To input a first order differential equation and draw a slope field

**0501** To input  $y' = y^2 - x$  and draw its slope field

#### • To input initial conditions and graph the solution curves

**0502** After performing the operation under example **0501**, to graph three solution curves for the initial conditions  $(x_i, y_i) = (0, 0), (0, 0.5), (0, 1)$

**Tip:** You can specify whether or not a solution curve should be drawn for each initial condition input on the initial condition editor. Use the initial condition editor to select the check box to the left of each initial condition input box (Initial Condition 1, Initial Condition 2, etc.) whose solution curve you want to graph. The solution curve of any initial condition whose check box is not selected will not be graphed.

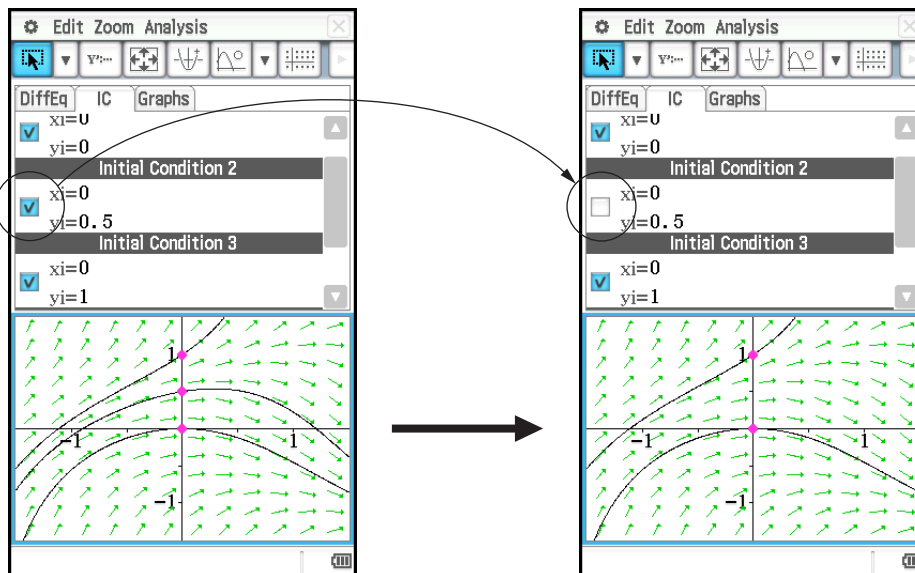

## Graphing a Second Order Differential Equation

This section explains how to input a second order differential equation, draw a phase plane, and graph the solution curve(s). With this application, a second order differential equation is input in the form of a set of two first order differential equations.

- A phase plane is the family of solutions of either a second order differential equation or two first order differential equations of the form  $x' = dx/dt = f(x, y)$  and  $y' = dy/dt = g(x, y)$ . A single second order differential equation can also be graphed, but it must be written as two first order differential equations.
- You can overlay, onto the phase plane, solution curves of the second order differential equation input on the [DiffEq] tab for given initial conditions.

### • To input a second order differential equation and draw a phase plane

**0503** To input  $\{x' = x, y' = -y\}$  and draw its phase plane

### • To input initial conditions and graph the solution curves

**0504** After performing the operation under example **0503**, to graph the solution curve of the initial condition  $(xi, yi) = (1, 1)$   
Independent variable minimum value ( $tmin$ ) =  $-7.7$ , maximum value ( $tmax$ ) =  $7.7$ , and initial value ( $t0$ ) =  $0$

## Graphing an Nth-order Differential Equation

This section explains how to graph the solution curve(s) for an  $n$ th-order (higher order) differential equation based on specified initial conditions. With this application, an  $n$ th-order differential equation is input in the form of a set of multiple first order differential equations.

**Note:** For  $n$ th-order differential equations, only solution curves are drawn.

### • To input an $n$ th-order differential equation and initial conditions, and then graph the solution curves

**0505** To specify the three initial conditions  $(xi, y1i, y2i) = (0, -1, 0), (0, 0, 0), (0, 1, 0)$  for the differential equation  $y''' = x - y$ , and graph its solution curves

## Configuring and Modifying Initial Conditions

You can modify an existing initial condition on the Differential Equation Graph window by dragging it. You can also configure a new initial condition on the Differential Equation Graph window by tapping the coordinates you want to specify as the new initial condition.

### • To modify an initial condition on the Differential Equation Graph window

1. Perform the operation under example **0505**, which will produce a graph like the one shown below to appear on the Differential Equation Graph window.

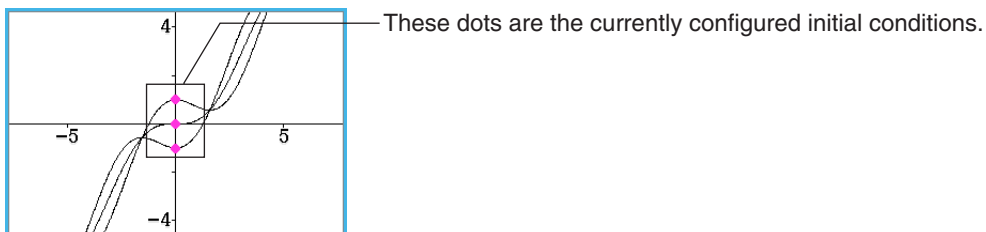

2. Tap [Analysis] - [Select] or .
3. Tap one of the initial condition dots to select it, and then use the stylus to drag the dot to another location.
  - Here we will drag the bottom dot, which is the Initial Condition 1 setting  $(x_i, y_{1i}, y_{2i}) = (0, -1, 0)$ . The applicable initial condition will change to the coordinates of the location where you release the stylus after dragging the dot, and the solution curve will be redrawn accordingly.

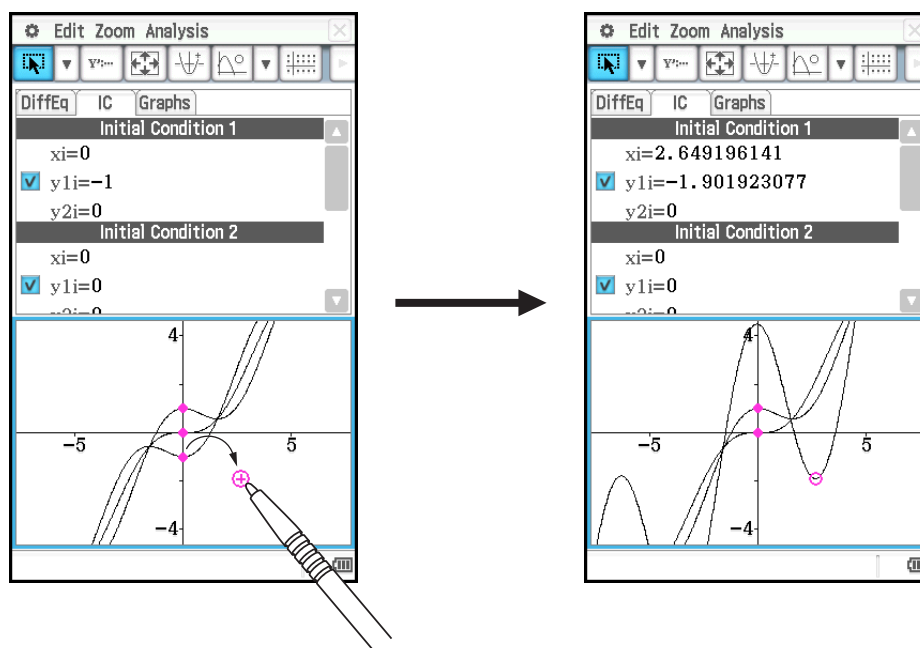

### • To configure new initial conditions on the Differential Equation Graph window

1. Perform the operation under example **0501** to produce a slope field on the Differential Equation Graph window.
2. Tap [Analysis] - [Modify] or .

3. On the Differential Equation Graph window, tap the coordinates that you want to specify as the new initial condition.

- This will set the coordinates as the new initial condition and draw a solution curve.

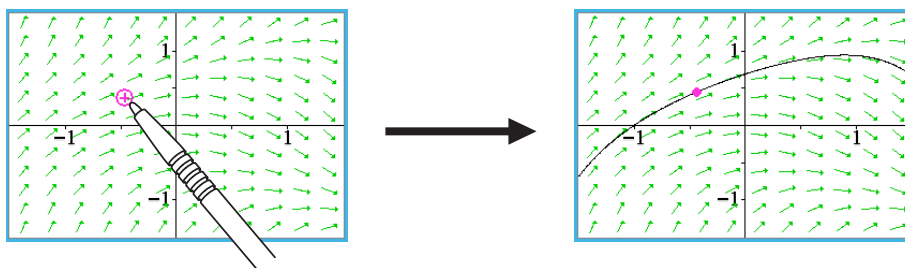

- The newly configured initial condition is added to the initial condition editor. To view it, tap the [IC] tab.

## Configuring Differential Equation Graph View Window Parameters

You can set a number of graphing parameters on the View Window dialog box. This dialog box contains two tabs.

The [Window] tab lets you set the window values and steps used for graphing a field. The [Solutions] tab contains parameters used for graphing solution curves.

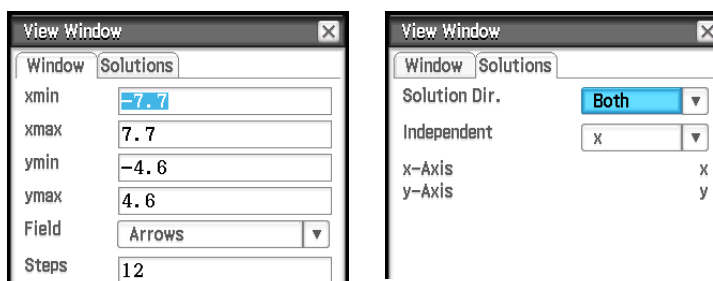

### • To configure differential equation graph View Window settings

1. Tap to display the View Window dialog box.
2. Input the required parameters on the [Window] and [Solutions] tabs.
  - See “Differential equation graph View Window parameters” below.
3. After the settings are the way you want, tap [OK].

### Differential equation graph View Window parameters

#### [Window] tab

Setting	Description
$x_{min}$ , $x_{max}$	Minimum/maximum value along the (horizontal) $x$ -axis
$y_{min}$ , $y_{max}$	Minimum/maximum value along the (vertical) $y$ -axis
Field	Specifies display of arrow, line or nothing.
Steps	Number of steps or field lines used for graphing a field

#### [Solutions] tab

The variable assignments available on the [Solutions] tab vary depending on the graph type selected with the Graph Editor. Some graph types have preset assignments for the independent,  $x$ -axis, and  $y$ -axis variables. If a value is preset for the current graph type the value will still be displayed on the Solutions tab, but you will not be able to change it.

Setting	Description
Solution Dir.	A solution curve is graphed starting at the initial condition value $t_0$ and continues until it reaches a target value, which can be either $t_{\min}$ or $t_{\max}$ . The solution direction determines the target values. Forward will graph the solution curve from $t_0$ to $t_{\max}$ . Backward will graph the solution curve from $t_0$ to $t_{\min}$ . Both will graph the solution curve from $t_0$ to $t_{\min}$ , and then $t_0$ to $t_{\max}$ .
Independent	Assignment of the independent variable for differential equations 1st-order, Nth-order: $x$ or $t$ 2nd-order: $t$ (fixed)
$t_0$ (or $x_0$ )	If the independent variable is different from the $x$ -axis variable, you can enter the initial value for the independent variable (2nd-order and Nth-order only).
$t_{\min}$ (or $x_{\min}$ ), $t_{\max}$ (or $x_{\max}$ )	If the independent variable is different from the $x$ -axis variable, you can enter the minimum/maximum value for the independent variable (2nd-order and Nth-order only).
$x$ -Axis	Variable assignment for the (horizontal) $x$ -axis 1st-order: same as independent variable 2nd-order: $x$ (fixed) Nth-order: independent variable or $y_1$ through $y_{10}$
$y$ -Axis	Variable assignment for the (vertical) $y$ -axis 1st-order, 2nd-order: $y$ (fixed) Nth-order: independent variable or $y_1$ through $y_{10}$

## 5-2 Drawing $f(x)$ Type Function Graphs and Parametric Function Graphs

$f(x)$  type function graphs and parametric function graphs can be overlaid on differential equation graphs.

- **To draw an  $f(x)$  type function graph**

**0506** To overlay a differential equation graph with the graphs of  $y = x^2$  and  $y = -x^2$

- **To draw a parametric function graph**

**0507** To graph  $\{xt = 3\sin(t) + 1, yt = 3\cos(t) + 1\}$   
(Angle unit setting: radian,  $0 \leq t \leq 2\pi$ )

## 5-3 Using Trace to Read Graph Coordinates

The trace function let you read the coordinates on graphs drawn with the Differential Equation Graph application. There are three types of trace: “point trace” (shows the coordinates of any point), “field trace” (shows the coordinates of center of each field line), and “graph/curve trace” (shows the coordinates of points on a graph or solution curve).

- **To start a point trace**

On the Differential Equation Graph window, tap .

- **To start a field trace**

Draw a slope field (page 123) or a phase plane (page 124), and then tap .

• **To start a graph/curve trace**

1. Draw a solution curve (pages 123 through 124) or function graph (page 127).
2. Tap  or [Analysis] - [Trace].

## 5-4 Graphing an Expression or Value by Dropping It into the Differential Equation Graph Window

You can use the procedures in this section to graph an expression or value by dragging it from the eActivity application window or the Main application window, and dropping it into the Differential Equation Graph window.

To draw this type of graph:	Drop this type of expression or value into the Differential Equation Graph window:
Slope field	1st-order differential equation in the form of $y' = f(x, y)$
Solution curve(s) of a 1st-order differential equation	<p>Matrix of initial conditions in the following form:  <math>[[x_1, y(x_1)][x_2, y(x_2)] \dots [x_n, y(x_n)]]</math></p> <ul style="list-style-type: none"> <li>• Note that the Slope field should already be graphed on the Differential Equation Graph window before the matrix is dropped in. If it isn't, dropping in the matrix will simply plot points at the coordinates indicated by each <math>(x, y)</math> pair.</li> <li>• Regardless of whether or not the Slope field is already graphed, values in the dropped in matrix will be registered to the [IC] tab of the Differential Equation Editor.</li> </ul>
Solution curve(s) of an $n$ th-order differential equation	<p>1) <math>n</math>th-order differential equation such as <math>y'' + y' + y = \sin(x)</math>, followed by</p> <p>2) Matrix of initial conditions in the following form:  <math>[[x_1, y1(x_1)][x_2, y1(x_2)] \dots [x_n, y1(x_n)]]</math> or  <math>[[x_1, y1(x_1), y2(x_1)][x_2, y1(x_2), y2(x_2)] \dots [x_n, y1(x_n), y2(x_n)]]</math></p>
$f(x)$ type function graph	Function in the form $y = f(x)$

**0508** To drag the 1st-order differential equation  $y' = \exp(x) + x^2$  and then the initial condition matrix  $[0, 1]$  from the eActivity application window to the Differential Equation Graph window, and graph the applicable slope field and solution curve

**0509** To drag the  $n$ th-order differential equation  $y'' + y' = \exp(x)$  and then the initial condition matrix  $[[0, 1, 0], [0, 2, 0]]$  from the eActivity application window to the Differential Equation Graph window, and graph the applicable solution curves

**Tip:** An  $n$ th-order differential equation of the form  $f(y', y'', \dots, x)$  dropped into the Differential Equation Graph window will be treated as  $f(y', y'', \dots, x) = 0$ .



# Chapter 6: Sequence Application

The Sequence application provides you with the tools you need to work with explicit sequences and recursive type sequences. Starting up the Sequence application displays two windows.

## ① Sequence Editor window

Use this window to input expressions for creating a sequence table.

## ② Table window

Use this window to create and display table.

(a) Title: Shows the equation used in the calculations. The title is not displayed when an item in column  $n$  is selected.

(b) Column names

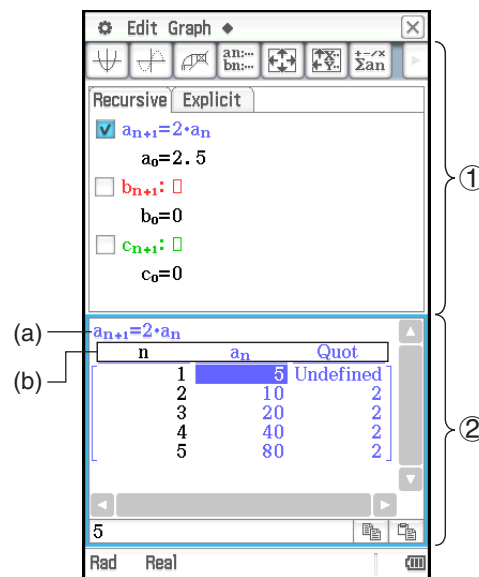

## Sequence Application-Specific Menus and Buttons

### Sequence Editor window

- Specify the recursion type ([Recursive] tab only)..... Type menu or  $\begin{matrix} n+1 \\ a_0 \end{matrix}$   $\begin{matrix} n+1 \\ a_1 \end{matrix}$   $\begin{matrix} n+2 \\ a_0a_1 \end{matrix}$   $\begin{matrix} n+2 \\ a_1a_2 \end{matrix}$
- Turn display of sequence table subtotals on or off .....  $\Sigma$  -  $\Sigma$ display - On/Off
- Show (On) in the message box or hide (Off) the expression used to draw a figure with Sketch, or show the expression only when **EXE** is pressed (StepDisp).....  $\Sigma$  - Set Sequence - On/Off/StepDisp
- Clear the contents of the currently active tab sheet.....  $\Sigma$  - Clear Sheet
- Delete the recursion expression in the current active line .....  $\Sigma$

### Sequence Table window

- Draw a connect type graph..... Graph - Connect or  $\Psi$
- Draw a plot type graph..... Graph - G-Plot or  $\Sigma$
- Save the contents of a table to a list.....  $\Sigma$  - Table to List
- Regenerate the currently displayed table .....  $\Sigma$  - ReTable
- Delete the currently displayed table.....  $\Sigma$  - Delete Table
- Execute a table and graph link trace.....  $\Sigma$  - Link
- To input a recursion term, tap the  $[n, a_n]$  menu and then tap the term you want. If the [Explicit] tab is displayed, you can also use the toolbar's  $\begin{matrix} n \end{matrix}$  to input a term- $n$ .

### Sequence RUN window

- Input the "rSolve" function..... Calc - rSolve
- Input the " $\Sigma$ " function..... Calc -  $\Sigma$
- Use the  $[n, a_n]$  menu to input recursion expression terms. You can also use the  $[a_0, a_1]$  menu to input system variables ranging from  $a_0$  to  $c_2$ .

## Buttons common to multiple windows

- Create an ordered pair table (Editor/Graph/RUN)
- Create a sequence table with column(s) that determine if a sequence is an arithmetic sequence, geometric sequence, progression of difference, or Fibonacci sequence (Editor/Graph/RUN) (arithmetic), (geometric), (progression of difference), (Fibonacci)
- Display the Sequence Table Input dialog box (Editor/Table/Graph/RUN)
- Draw a cobweb diagram on a graph (Editor/Table)
- Display the Sequence RUN window (Editor/Table/Graph)
- Display the Sequence Editor window (Table/Graph/RUN)

## 6-1 Recursive and Explicit Form of a Sequence

ClassPad supports use of three types of sequence expressions:  $a_{n+1} =$ ,  $a_{n+2} =$  and  $a_n E$ .

### Generating a Number Table

In addition to an ordered pair table, you can create a sequence table with column(s). This helps you determine if the sequence is an arithmetic sequence, geometric sequence, progression of difference, or Fibonacci sequence.

Recursive		Explicit	
<input checked="" type="checkbox"/>	$a_{n+2} = a_{n+1} + a_n$		
	$a_1 = 1$		
	$a_2 = 1$		
<input type="checkbox"/>	$b_{n+2} =$		
	$b_1 = 0$		
	$b_2 = 0$		
<input type="checkbox"/>	$c_{n+2} =$		

n	$a_n$	Sum
1	1	Undefined
2	1	2
3	2	3
4	3	5
5	5	8

$3 = 2 + 1$

Fibonacci Sequence Table

Recursive		Explicit	
<input checked="" type="checkbox"/>	$a_n E = n^2 - 2$		
<input type="checkbox"/>	$b_n E =$		
<input type="checkbox"/>	$c_n E =$		

n	$a_n E$
1	-1
2	2
3	7
4	14
5	23

Ordered Pair Table

Recursive		Explicit	
<input checked="" type="checkbox"/>	$a_{n+1} = a_n + 3$		
	$a_1 = 1$		
<input type="checkbox"/>	$b_{n+1} =$		
	$b_1 = 0$		
<input type="checkbox"/>	$c_{n+1} =$		
	$c_1 = 0$		

n	$a_n$	Dfrn
1	1	Undefined
2	4	3
3	7	3
4	10	3
5	13	3

$3 = 7 - 4$

Arithmetic Sequence Table

Recursive		Explicit	
<input checked="" type="checkbox"/>	$a_{n+1} = 3 \cdot a_n$		
	$a_1 = 2$		
<input type="checkbox"/>	$b_{n+1} =$		
	$b_1 = 0$		
<input type="checkbox"/>	$c_{n+1} =$		
	$c_1 = 0$		

n	$a_n$	Quot
1	2	Undefined
2	6	3
3	18	3
4	54	3
5	162	3

$3 = 18 \div 6$

Geometric Sequence Table

Recursive		Explicit	
<input checked="" type="checkbox"/>	$a_{n+1} = 2 \cdot a_n + 2$		
	$a_1 = 3$		
<input type="checkbox"/>	$b_{n+1} =$		
	$b_1 = 0$		
<input type="checkbox"/>	$c_{n+1} =$		
	$c_1 = 0$		

n	Dfrn	Quot
1	Undefined	Undefined
2	8	Undefined
3	10	2
4	20	2
5	40	2

$5 = 8 - 3$

$2 = 20 \div 10$

Progression of Difference Table

**0601** To create a number table (Fibonacci sequence table) to check the Fibonacci sequence expressed by the recursion formula  $a_{n+2} = a_{n+1} + a_n$ ,  $a_1 = 1$ ,  $a_2 = 1$

## Determining the General Term of a Recursion Expression

You can use the rSolve function to convert the sequence expressed by a recursion expression to the general term format  $a_n = f(n)$ .

**0602** To determine the general term of the recursion expression  $a_{n+1} = a_n + 2$ ,  $a_1 = 1$

### About rSolve

The rSolve function returns the explicit formula of a sequence that is defined in relation to one or two previous terms, or a system of recursive formulas.

Syntax: rSolve (Eq, initial condition-1[, initial condition-2] [ ] )

rSolve ({Eq-1, Eq-2}, {initial condition-1, initial condition-2} [ ] ) (Eq: Equation)

**Example:** To obtain the  $n$ -th term of a recursion formula  $a_{n+1} = 3a_n - 1$  with the initial conditions  $a_1 = 1$

```
rSolve(a_{n+1}=3a_n-1, a_1=1)
{a_n = \frac{3^n - 1}{2} + \frac{1}{2}}
```

## Calculating the Sum of a Sequence

Perform the following steps when you want to determine the sum of a specific range of the sequence of a recursion expression or a general term expression.

**0603** To calculate the sum of the general term expression  $a_n E = n^2 + 2n - 1$  in the range of  $2 \leq n \leq 10$

## 6-2 Graphing a Recursion

ClassPad lets you graph the values in a number table you create, and draw a cobweb diagram from the recursion expression.

**0604** To input the expression  $a_{n+1} = 2a_n + 1$ ,  $a_1 = 1$ , create a number table, and graph the values in the table

**0605** To input the expression  $a_{n+1} = \frac{a_n^2}{2} - 1$ ,  $a_1 = 0.5$  and draw a cobweb diagram

### About LinkTrace

While the Table and Graph windows are on the display, you can activate LinkTrace. To do this, tap in the Table window to make it active. Next, tap  and then [Link]. While LinkTrace is active, the pointer on the Graph window jumps automatically to the point indicated by the coordinates in the currently selected table cell. Note that LinkTrace does not work when the selected cell is in the first column (column  $n$ ).

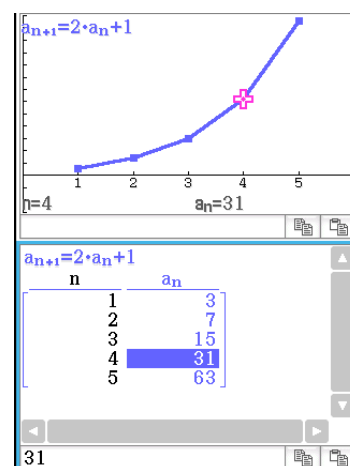
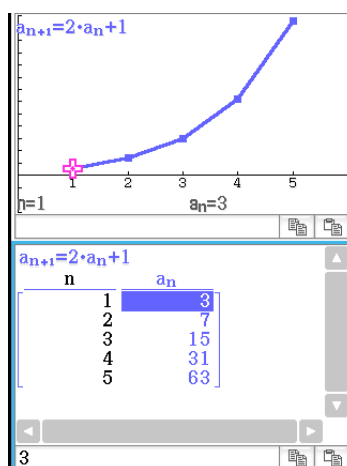

# Chapter 7: Statistics Application

The Statistics application provides you with the tools you need to perform the operations below.

- **Statistical data input** (as list variables)
- **Statistical graph drawing:**  
Single-variable statistical graphs and paired-variable statistical graphs
- **Statistical calculations:**  
Single-variable, paired-variable, regression, test, confidence interval, and distribution calculations

**Tip:** Performing a statistical calculation, graphing operation or other operation causes calculation results to be assigned to pre-determined system variables. For more information, see the “System Variable Table” on page 299.

## 7-1 Using Stat Editor

When you start up the Statistics application, the Stat Editor window shown to the right appears on the display.

Stat Editor is a tool for creating and maintaining lists (list variables), and it plays a very important role in ClassPad statistical calculations. ClassPad uses lists as data sources for statistical calculations and for statistical graphing. You can specify data by its list name.

The list name is located in the cell at the top of each list. The initial default Stat Editor window shows six lists (columns), named list1 through list6.

List name

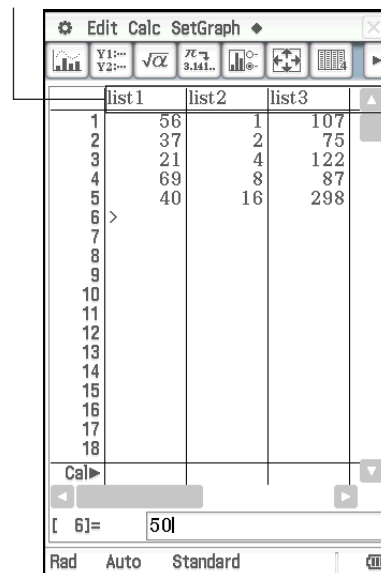

### Basic List Operations

You can use the Stat Editor window to input and edit the data in the initially displayed list1 through list6. You can also recall list variables you created with the Main application\* and create new list variables.

\* See **0240** and **0241** in the separate “Examples” booklet.

#### • To input data into a list

1. On the Stat Editor window, select the cell where you want to input the data item.
  - Use the cursor key to move the highlighting, or tap the cell with the stylus.

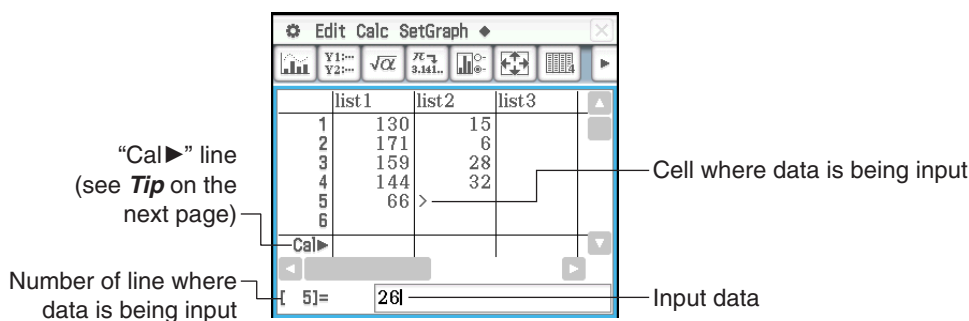

2. Input the data you want.

- You can input values, formulas, or variable names. If you input a formula, the value of the calculation result will be input into the list. If you input a variable name, the value currently assigned to the variable (or the variable name itself in the case of an undefined variable) will be input into the list.
- After you input a formula into a cell, the calculation result will be displayed as a decimal value or a fraction in accordance with the “Decimal Calculation” setting of the Basic Format dialog box (page 36).

3. Press **[EXE]** to store the data in the cell.

### Tip

- Inputting a formula that includes a list (page 57) into a “Cal▶” line and then pressing **[EXE]** will cause the calculation result list data to replace the contents currently in the list being input. For example, inputting {1,2,3}<sup>2</sup> into the “Cal▶” line of list1 and then pressing **[EXE]** will cause list1 to be overwritten with {1,4,9}. Any data previously in list1 is lost.
- A list can contain up to 9,999 rows.
- A locked variable (page 30) causes the  icon to be displayed in the “Cal▶” line, which cannot be edited.

### • To create a list

1. On the Stat Editor window, tap a list name cell to select it.

2. Enter up to eight bytes for the list name you want, and then press **[EXE]**.

- This creates a list variable with the name you specified. After that, you can input data using the procedure under “To input data into a list”.
- If you enter a list name that is already used for another list, pressing **[EXE]** displays the contents of that list.

### • To open an existing list

1. On the Stat Editor window, select the list name cell of the column where you want the list you will open to appear.

- Instead of the above operation, you could also select any cell in the column where you want the list you will open to appear and then tap [Edit] - [Open List].

2. Enter the variable name of the list you want to open, and then press **[EXE]**.

- If you enter a variable name that does not match the names of any of the existing lists in step 1, a new list will be created using the name you entered.

### • To close a list





Select the list name cell of the column of the list you want to close, and then press  **[EXE]**.





Or, select any cell of the list you want to close, and then tap [Edit] - [Close List].

- This operation clears the list from the display only. The list is still stored as a list variable in memory, and can be opened when you need it again.

---

## Menus and Buttons Used for List Editing

- Jump to line 1 of the current list..... Edit - Jump - Top
- Jump to the line after the last line of the current list..... Edit - Jump - Bottom
- Sort list data ascending.....Edit - Sort - Ascending or 
- Sort list data descending..... Edit - Sort - Descending or 
- Delete a cell ..... Edit - Delete - Cell or 
- Delete all of the data in a list..... Edit - Delete - Column or 
- Delete a list from memory ..... Edit - Delete - List Variable
- Insert a cell into a list ..... Edit - Insert Cell or 
- Select all the text in the currently selected cell ..... Edit - Select All

- Clear list variable data from list1 through list6 and initialize Stat Editor window contents ..... Edit - Clear All
- Convert a mathematical expression in the currently selected cell to a decimal value ..... 
- Display two, three, or four columns in the Stat Editor window\* .....  /  / 

\* You can also specify the number of display columns using the [Cell Width Pattern] setting on the [Special] tab of the Graph Format dialog box (page 38).

## Using CSV Files

You can import the contents of a CSV file stored with the ClassPad or transferred from a computer into the Stat Editor. You also can save the contents of all the list data in the Stat Editor as a CSV file.

### Import CSV File Requirements

A CSV file that has been output from the Stat Editor or Spreadsheet (Chapter 13), or a CSV file transferred from a computer to storage memory can be used for import. The following types of CSV files are supported for import.

- A CSV file that uses the comma (,) or semi-colon (;) as its separator, and the period (.) or comma (,) as its decimal symbol. A CSV file that uses the tab as its separator is not supported.
- CR, LF and CRLF are supported for the line break code.

For information about transferring files from a computer to the calculator, see “19-2 Performing Data Communication between the ClassPad and a Personal Computer”.

### Stat Editor Display and List Data Overwriting Following CSV File Import

When you import a CSV file into Stat Editor, everything displayed on the Stat Editor screen is cleared and replaced with the imported CSV file data.

The first column of the CSV file data is imported into the Stat Editor column 1 list (list 1), the second column of file data is imported into Stat Editor column 2 list (list 2), and so on. List data is created for each of the CSV file columns. Any data previously stored in a list is overwritten by the imported data.

Except for data that is overwritten by the CSV file import, current list data cleared from the Stat Editor screen by the import operation is retained in ClassPad memory.

#### • To import the contents of a CSV file to the Stat Editor

1. Prepare the CSV file you want to import.
  - See “Import CSV File Requirements” described above.
2. While the Stat Editor is on the display, tap [Edit] - [CSV] - [Open CSV].
3. On the dialog box that appears, select the CSV file you want to import and then tap [Open].

#### **Important!**

- Importing a CSV file that has a large number of rows and/or columns may cause an insufficient memory error. If this happens, reduce the number of rows and/or columns in the CSV file.
- Following import, the contents of all cells that contain character strings are automatically replaced with 0.

#### • To save the contents of all the list data in the Stat Editor as a single CSV file

1. While the Stat Editor is on the display, tap [Edit] - [CSV] - [Save CSV].
2. On the dialog box that appears, specify the export destination folder and then input a name for the export file.
3. Tap [Save].

#### **Important!**

The list name line and Cal▶ line are not output to the CSV file.

• **To specify the CSV file separator and decimal symbol**

1. While the Stat Editor is on the display, tap [Edit] - [CSV] - [CSV Format].
2. On the dialog box that appears, specify the desired settings for “CSV Separator” and “CSV Decimal Symbol”.
3. To save the settings, tap [OK].

## 7-2 Drawing a Statistical Graph

Up to nine graphs, including single-variable data and paired-variable data statistical graphs can be drawn simultaneously ([SetGraph] - [StatGraph1] to [StatGraph9]).

In addition to graphs that can be drawn using [Set Graph], the graphs below can also be drawn at the same time.

- Regression graphs (using [Linear Reg] and other regression commands on the [Calc] - [Regression] menu)
- Function graphs (using the Graph & Table application’s Graph Editor window)

### Operation Flow Up to Statistical Graphing

Drawing a statistical graph requires the following basic steps: (1) preparation of the list data to be used; (2) selection of the graph type and other graph settings; (3) drawing of the graph.

• **To prepare list data for statistical graphing**

Prepare the list data using one of the patterns shown below.

Single Variable		Paired Variable																																							
Without frequency	With frequency	Without frequency	With frequency																																						
Single list	Two lists	Two lists	Three lists																																						
<table border="1"> <tr><td>9</td></tr> <tr><td>9</td></tr> <tr><td>10</td></tr> <tr><td>7</td></tr> <tr><td>8</td></tr> <tr><td>8</td></tr> </table>	9	9	10	7	8	8	<table border="1"> <tr><td>9</td><td>2</td></tr> <tr><td>9</td><td>1</td></tr> <tr><td>10</td><td>1</td></tr> <tr><td>7</td><td>2</td></tr> </table>	9	2	9	1	10	1	7	2	<table border="1"> <tr><td>9</td><td>120</td></tr> <tr><td>9</td><td>121</td></tr> <tr><td>10</td><td>127</td></tr> <tr><td>7</td><td>128</td></tr> <tr><td>8</td><td>129</td></tr> <tr><td>8</td><td>130</td></tr> </table>	9	120	9	121	10	127	7	128	8	129	8	130	<table border="1"> <tr><td>9</td><td>120.5</td><td>2</td></tr> <tr><td>10</td><td>127</td><td>1</td></tr> <tr><td>7</td><td>128</td><td>1</td></tr> <tr><td>8</td><td>129.5</td><td>2</td></tr> </table>	9	120.5	2	10	127	1	7	128	1	8	129.5	2
9																																									
9																																									
10																																									
7																																									
8																																									
8																																									
9	2																																								
9	1																																								
10	1																																								
7	2																																								
9	120																																								
9	121																																								
10	127																																								
7	128																																								
8	129																																								
8	130																																								
9	120.5	2																																							
10	127	1																																							
7	128	1																																							
8	129.5	2																																							
Data	Data    Frequency	Paired data	Paired data    Frequency																																						

**Tip**

- Single-variable data is data that consists of a single value. If you are trying to obtain the average height of the members of a single class, for example, the single-variable would be height. With paired-variable statistical data there are two values for each data item. An example of paired-variable statistical data would be the change in size of an iron bar as its temperature changes. One variable would be temperature, and the other variable is the corresponding bar size.
- If you created user list data with another application, open it in the Stat Editor window. For more information, see “To open an existing list” (page 133). You can specify a list displayed in the Stat Editor window as data to be used for statistical graphing.
- You can display up to 99 lists on the Stat Editor window.

• **To configure statistical graph settings**

- On the Stat Editor window, tap [SetGraph] - [Setting...] or tap .
  - This displays the Set StatGraphs dialog box. There are tabs named 1 through 9 that correspond to StatGraph1 through StatGraph9.
  - Each tab is assigned a color. Tabs [1] and [6]: Blue; Tabs [2] and [7]: Red; Tabs [3] and [8]: Green; Tabs [4] and [9]: Magenta; Tab [5]: Black
- Tap the tab for the StatGraph setup whose configuration you want to change.
- Configure the StatGraph setup settings you want as described below.

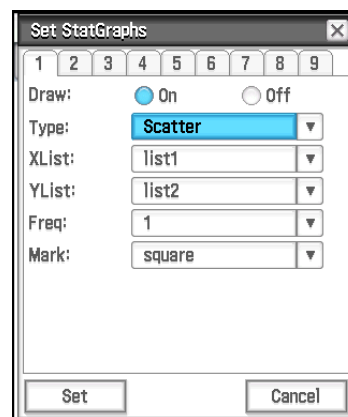

**Draw:** Select the On setting if you want to draw the tab’s graph, or Off if you do not want to draw it. After closing the dialog box, tap on the toolbar to execute the graph draw operation.

**Type:** Selects the type of graph to be drawn. The types of graphs available for selection depend on whether the graph data is single-variable or paired-variable.

<b>Single-variable</b>	NPPlot, Histogram, MedBox, NDist, Broken
<b>Paired-variable</b>	Scatter, <i>xy</i> Line, LinearR, MedMed, QuadR, CubicR, QuartR, LogR, ExpR, abExpR, PowerR, SinR, LogisticR

For details about each graph type, see “Graphing Single-Variable Statistical Data” (page 136) and “Graphing Paired-Variable Statistical Data” (page 137).

**XList, YList, Freq:** Specifies the list data to be used for graphing. If you prepared frequency list data, use Freq to specify the frequency list.

**Mark:** This setting is supported only when Scatter, *xy*Line, or NPPlot is specified for “Type”. Select square (□), cross (×), large dot (■) or dot (•) as the shape for graph lot points.

- Tap [Set] to apply the settings for the tab you selected in step 2.

• **To draw a statistical graph**

- On the Stat Editor window, tap [SetGraph], and then confirm that there is at least one item from [StatGraph1] to [StatGraph9] whose check box is selected.
  - If no check box is selected, select at least one check box. Selecting multiple check boxes will cause the corresponding graphs to be drawn simultaneously.
- Configure the - [Stat Window Auto] - [On] / [Off] setting as required.
  - Selecting [On] for this setting configures View Window settings for drawing statistical graphs automatically. See “Graph Format Dialog Box” (page 38) for details.
- Tap to display the Stat Graph window and draw the statistical graphs.

**0701** To input the paired-variable data shown below and then plot the data on a scatter plot

list1 = 0.5, 1.2, 2.4, 4.0, 5.2      list2 = -2.1, 0.3, 1.5, 2.0, 2.4

**Graphing Single-Variable Statistical Data**

You can produce any of the graphs described below using single-variable data. The text in the parentheses of the graph names below shows text that appears on the Type menu of the Set StatGraphs dialog box.

**Normal Probability Plot (NPPlot)**

The normal probability plot plots data against a theoretical normal distribution using a scatter plot. If the scatter plot is close to a straight line, then the data is approximately normal. A departure from the straight line indicates a departure from normality.

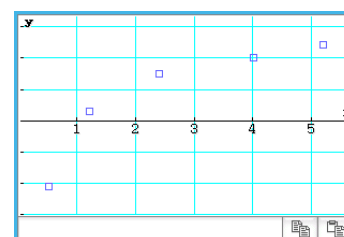



### Med-Box Plot (MedBox)

This type of graph is often called a “Box and Whisker” graph. It lets you see how a large number of data items are grouped within specific ranges. The lines from minX to Q<sub>1</sub>, and from Q<sub>3</sub> to maxX are called “whiskers”. If [Show Outliers] box is checked on the Set StatGraphs dialog box (page 136), “outlier” square symbols are shown instead of “whisker” lines where a data value is relatively large or small compared to the other data values.

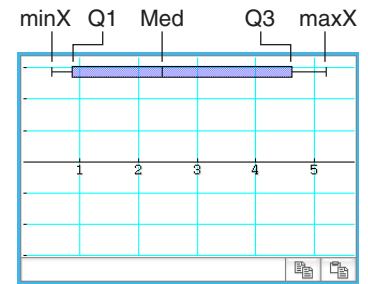

### Normal Distribution Curve (NDist)

The normal distribution curve is graphed using the following normal distribution function.

$$y = \frac{1}{\sqrt{2\pi}\sigma} e^{-\frac{(x-\bar{x})^2}{2\sigma^2}}$$

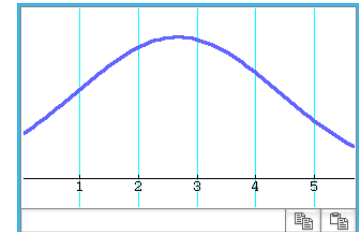

### Histogram Bar Graph (Histogram), Broken Line Graph (Broken)

A histogram shows the frequency (frequency distribution) of each data class as a rectangular bar. Classes are on the horizontal axis, while frequency is on the vertical axis.

In the broken line graph, lines connect the pointers that fall at the center of each histogram bar.

The Set Interval dialog box appears before the graph is drawn. You can use this dialog box to change the start value (HStart) and step value (HStep) of the histogram, if you want.

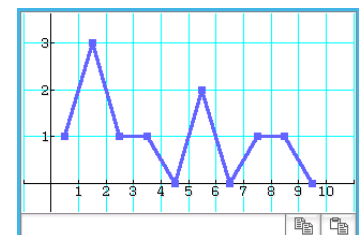
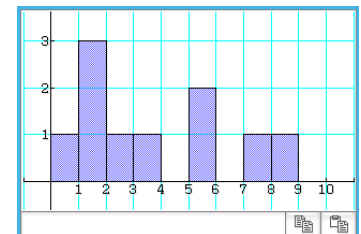

## Graphing Paired-Variable Statistical Data

You can produce any of the graphs described below using paired-variable data. The text in the parentheses of the graph names below shows text that appears in the Type menu of the Set StatGraphs dialog box (page 136).

### ■ Plot graphs

Draws graphs by plotting paired-variable points with *x* data on the horizontal axis and *y* data on the vertical axis.

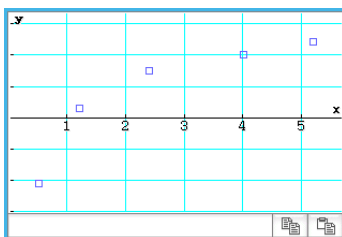

Scatter plot (Scatter)

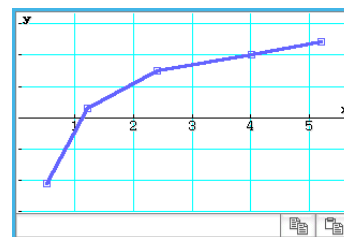

xy line graph (xyLine)

## ■ Regression graphs

Regression graphs of each of the paired-variable data can be drawn according to the model formulas under “Regression types” below.

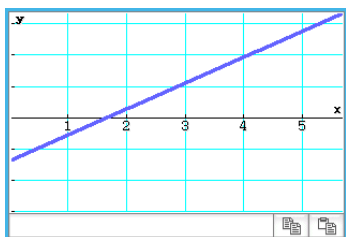

Linear regression graph

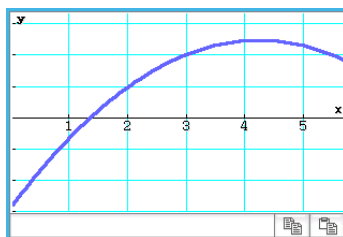

Quadratic regression graph

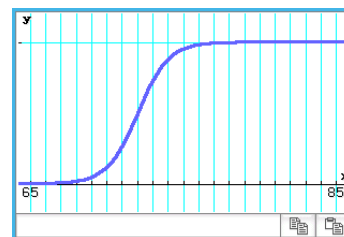

Logistic regression graph

### Regression types:

- **Linear regression** (LinearR) [Linear Reg] .....  $y = a \cdot x + b$ ,  $y = a + b \cdot x$   
Linear regression uses the method of least squares to determine the equation that best fits your data points, and returns values for the slope and y-intercept. The graphic representation of this relationship is a linear regression graph.
- **Med-Med line** (MedMed) [MedMed Line] .....  $y = a \cdot x + b$   
When you suspect that the data contains extreme values, you should use the Med-Med graph (which is based on medians) in place of the linear regression graph. Med-Med graph is similar to the linear regression graph, but it also minimizes the effects of extreme values.
- **Quadratic regression** (QuadR) [Quadratic Reg] .....  $y = a \cdot x^2 + b \cdot x + c$
- **Cubic regression** (CubicR) [Cubic Reg] .....  $y = a \cdot x^3 + b \cdot x^2 + c \cdot x + d$
- **Quartic regression** (QuartR) [Quartic Reg] .....  $y = a \cdot x^4 + b \cdot x^3 + c \cdot x^2 + d \cdot x + e$   
Quadratic, cubic, and quartic regression graphs use the method of least squares to draw a curve that passes the vicinity of as many data points as possible. These graphs can be expressed as quadratic, cubic, and quartic regression expressions.
- **Logarithmic regression** (LogR) [Logarithmic Reg] .....  $a + b \cdot \ln(x)$   
Logarithmic regression expresses  $y$  as a logarithmic function of  $x$ . The normal logarithmic regression formula is  $y = a + b \cdot \ln(x)$ . If we say that  $X = \ln(x)$ , then this formula corresponds to the linear regression formula  $y = a + b \cdot X$ .
- **$a \cdot e^{b \cdot x}$  Exponential regression** (ExpR) [Exponential Reg] .....  $y = a \cdot e^{b \cdot x}$   
Exponential regression can be used when  $y$  is proportional to the exponential function of  $x$ . The normal exponential regression formula is  $y = a \cdot e^{b \cdot x}$ . If we obtain the natural logarithms of both sides, we get  $\ln(y) = \ln(a) + b \cdot x$ . Next, if we say that  $Y = \ln(y)$  and  $A = \ln(a)$ , the formula corresponds to the linear regression formula  $Y = A + b \cdot x$ .
- **$a \cdot b^x$  Exponential regression** (abExpR) [abExponential Reg] .....  $y = a \cdot b^x$   
Exponential regression can be used when  $y$  is proportional to the exponential function of  $x$ . The normal exponential regression formula in this case is  $y = a \cdot b^x$ . If we take the natural logarithms of both sides, we get  $\ln(y) = \ln(a) + (\ln(b)) \cdot x$ . Next, if we say that  $Y = \ln(y)$ ,  $A = \ln(a)$  and  $B = \ln(b)$ , the formula corresponds to the linear regression formula  $Y = A + B \cdot x$ .
- **Power regression** (PowerR) [Power Reg] .....  $y = a \cdot x^b$   
Power regression can be used when  $y$  is proportional to the power of  $x$ . The normal power regression formula is  $y = a \cdot x^b$ . If we obtain the logarithms of both sides, we get  $\ln(y) = \ln(a) + b \cdot \ln(x)$ . Next, if we say that  $X = \ln(x)$ ,  $Y = \ln(y)$ , and  $A = \ln(a)$ , the formula corresponds to the linear regression formula  $Y = A + b \cdot X$ .
- **Sinusoidal regression** (SinR) [Sinusoidal Reg] .....  $y = a \cdot \sin(b \cdot x + c) + d$   
Sinusoidal regression is best for data that repeats at a regular fixed interval over time.

- **Logistic regression** (LogisticR) [Logistic Reg].....  $y = \frac{c}{1 + a \cdot e^{-b \cdot x}}$   
 Logistic regression is best for data whose values continually increase over time, until a saturation point is reached.

**Tip:** Though ClassPad internally performs regression calculations after drawing a regression graph using the settings of the Set StatGraphs dialog box (page 136), the calculation results (regression formula coefficients and other values) cannot be displayed. To display regression calculation results, use the commands on the [Calc] - [Regression] menu, which are shown in square brackets ([ ]) above.

## Overlaying a Regression Graph on a Scatter Plot

You can use the Set StatGraphs dialog box (page 136) to plot a scatter plot\* from paired-variable data and then overlay a regression graph on it. This means you can visually determine which regression formula is closest to the scatter plot.

\* You can also overlay on other graph types as well.

### • ClassPad Operation

1. Draw the scatter plot. Here we will use the operation under **0701** in the separate “Examples” booklet.
2. On the [Calc] - [Regression] menu, select one of the regression calculation commands (from [Linear Reg] to [Logistic Reg]).
  - Here we will select [Logarithmic Reg]. This displays the Set Calculation dialog box.

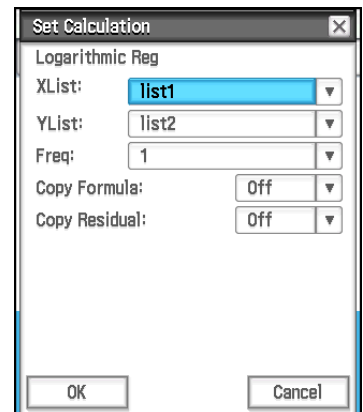

3. Here, we want to overlay on a scatter plot, so we specify XList, YList, and Freq the same as in step 1 of the procedure for drawing a scatter plot.
4. Tap [OK].
  - This displays the Stat Calculation dialog box. For information about this dialog box’s contents, see “Performing Regression Calculations” (page 143).

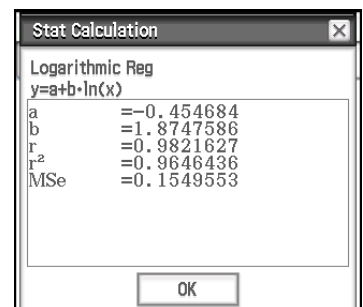

5. Tap [OK].
  - This draws the regression calculation graph over the scatter plot. This regression graph is always drawn in blue.
  - You can perform trace (page 111) on a regression graph. Trace scroll, however, is not supported when a scatter plot is displayed.

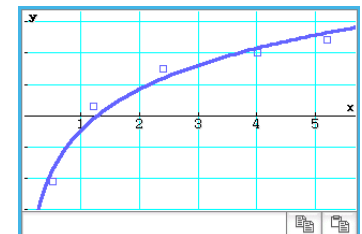

### Tip

- When performing Sinusoidal regression, make sure that “Radian” is selected for the [Angle] setting on the Basic Format dialog box (page 36). The graph cannot be drawn correctly when the [Angle] setting is anything other than “Radian”.
- When performing Sinusoidal regression or Logistic regression, certain types of data may cause calculation to take a long time. This is normal and does not indicate malfunction.





- Whenever you perform a regression calculation from the [Calc] - [Regression] menu, the [Previous Reg] check box on the [SetGraph] menu is selected automatically. This tells ClassPad to remember the calculation results produced by the last executed regression calculation command (the menu command selected in step 2 of the above procedure). As long as the [Previous Reg] check box is selected, any time you draw a new graph, it is drawn based on the last regression calculation results. To cancel drawing of this regression graph, clear the check box next to [Previous Reg] before re-drawing the graph.



## Overlaying a Function Graph on a Statistical Graph

You can overlay an existing statistical graph with any type of function graph.











Function graphs that can be overlaid are graphs of functions registered on the Graph Editor window of the Graph & Table application (Chapter 3). The Graph Editor window can also be accessed from the Statistics application.

### • ClassPad Operation

1. Draw a statistical graph as described under “Operation Flow Up to Statistical Graphing” (page 135).
2. Tap  to display the Graph Editor window.
3. Input the function.
4. Select the check boxes of all the functions you want to graph, and clear the check boxes of all the functions you do not want to graph.
5. Tap  on the Graph Editor window.
  - This draws the function graph on the statistical graph.
  - To close the Graph Editor window, Tap  to make it active, and then tap .

**Tip:** While the Stat Editor window [SetGraph] - [Graph Function] check box (or the Stat Graph window  - [Graph Function] check box) is selected, each tap of  on the Stat Editor window will draw the statistical graph along with a graph of the function registered by the Graph Editor window of the Graph & Table application.

## Stat Graph Window Menus and Buttons

- Display the Stat Editor window ..... 
- Display the Graph Editor window ..... 
- Redraw the displayed graph .....  - ReDraw or 
- Display the View Window dialog box .....  - View Window or 
- Start a trace operation ..... Analysis - Trace or 
- Display the Set StatGraphs dialog box ..... 
- Display the Main application work area window ..... 
- Pan the window ..... 
- Toggle the [Stat Window Auto] setting between auto and manual ..... 

### Note

- For details about the commands included on the Calc menu, see sections 7-3 and 7-4 of this manual.
- For information about Zoom, Analysis - Trace, Analysis - Sketch, and the commands included in the  menu, see “Chapter 3: Graph & Table Application”.

# 7-3 Performing Basic Statistical Calculations

Mean, standard deviation, and other statistical values can be obtained from single-variable data and paired-variable data. Regression calculation can also be performed on paired-variable data. All of these calculations are performed using [Calc] menu commands.

## Calculating Statistical Values

You can use the procedure below to display a lists of various single-variable and paired-variable statistical values.

### • To display single-variable calculation results

1. On the Stat Editor window or Stat Graph window, tap [Calc] - [One-Variable].
2. On the dialog box that appears, specify the [XList] name, select the [Freq] setting, and then tap [OK].
  - This displays the dialog box with the single-variable statistical calculation results described below.

$\bar{x}$ :	sample mean	$Q_1$ :	first quartile
$\Sigma x$ :	sum of data	Med:	median
$\Sigma x^2$ :	sum of squares	$Q_3$ :	third quartile
$\sigma_x$ :	population standard deviation	maxX:	maximum
$s_x$ :	sample standard deviation	Mode:	mode*
$n$ :	sample size	ModeN:	number of data mode items
minX:	minimum	ModeF:	data mode frequency

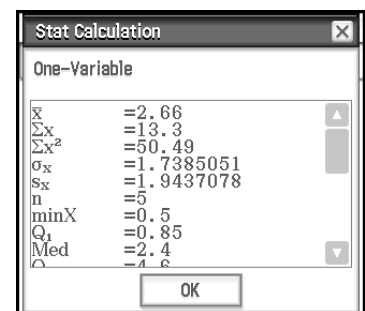

\* If "Mode = ►ModeStat" is displayed, it means that solutions are stored in the "ModeStat" system variable. To view the "ModeStat" contents, tap any list name cell on the Stat Editor window, input "ModeStat", and then press [EXE].

### Calculation Methods for $Q_1$ , $Q_3$ and Median

$Q_1$  and  $Q_3$  can be calculated in accordance with the [Q<sub>1</sub>, Q<sub>3</sub> on Data] setting on the Basic Format dialog box (page 36) as described below.

#### [Q<sub>1</sub>, Q<sub>3</sub> on Data] unchecked (default):

##### (a) When all Frequency values are integers

With this calculation method, processing depends on whether the number of elements  $n$  in the population is an even number or odd number.

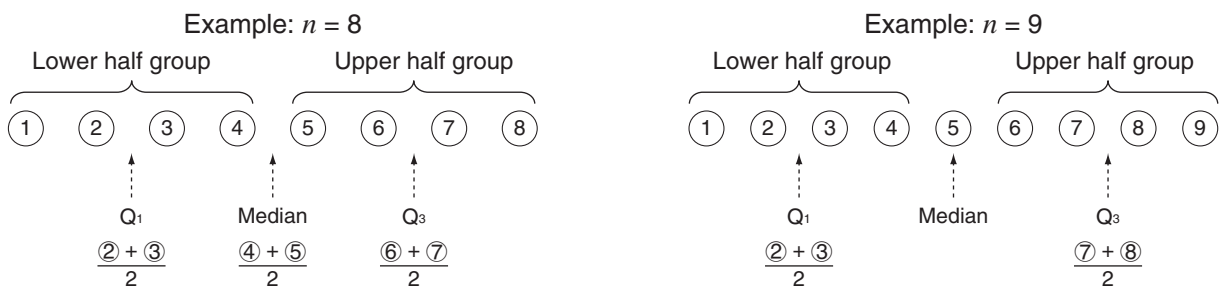

- When  $n$  is an even number, using the center point of the total population as the reference, the population elements are divided into two groups: a lower half group and an upper half group.  $Q_1$  and  $Q_3$  then become the values described below.

$Q_1$  = {median of the group of  $n/2$  items from the bottom of the population}

$Q_3$  = {median of the group of  $n/2$  items from the top of the population}

Median = {center point of the total population}

- When  $n$  is an odd number, using the median of the total population as the reference, the population elements are divided into two groups: values less than the median and values greater than the median. The median value is excluded.  $Q_1$  and  $Q_3$  then become the values described below.

$Q_1 = \{\text{median of the group of } (n - 1)/2 \text{ items from the bottom of the population}\}$

$Q_3 = \{\text{median of the group of } (n - 1)/2 \text{ items from the top of the population}\}$

Median = {center point of the total population}

- When  $n = 1$ ,  $Q_1 = Q_3 = \text{Median} = \text{population center point}$ .

**(b) When Frequency includes decimal fraction values**

The  $Q_1$ ,  $Q_3$  and Median values for this calculation method are described below.

$Q_1 = \{\text{value of element whose cumulative frequency ratio is greater than } 1/4 \text{ and nearest to } 1/4\}$

When the cumulative frequency ratio for some data value is exactly 0.25,  $Q_1$  is the average of that data value and the next data value.

$Q_3 = \{\text{value of element whose cumulative frequency ratio is greater than } 3/4 \text{ and nearest to } 3/4\}$

When the cumulative frequency ratio for some data value is exactly 0.75,  $Q_3$  is the average of that data value and the next data value.

Median = {value of element whose cumulative frequency ratio is greater than 1/2 and nearest to 1/2}

When the cumulative frequency ratio for some data value is exactly 0.5, Median is the average of that data value and the next data value.

The following shows an actual example of the above.

Data Value	Frequency	Cumulative Frequency	Cumulative Frequency Ratio
1	0.1	0.1	0.1/1.0 = 0.1
2	0.1	0.2	0.2/1.0 = 0.2
3	0.2	0.4	0.4/1.0 = 0.4
4	0.3	0.7	0.7/1.0 = 0.7
5	0.1	0.8	0.8/1.0 = 0.8
6	0.1	0.9	0.9/1.0 = 0.9
7	0.1	1.0	1.0/1.0 = 1.0

- 3 is the value whose cumulative frequency ratio is greater than 1/4 and nearest to 1/4, so  $Q_1 = 3$ .
- 5 is the value whose cumulative frequency ratio is greater than 3/4 and nearest to 3/4, so  $Q_3 = 5$ .
- 4 is the value whose cumulative frequency ratio is greater than 1/2 and nearest to 1/2, so Median = 4.

**[ $Q_1$ ,  $Q_3$  on Data] checked:**

The  $Q_1$ ,  $Q_3$  and Median values for this calculation method are described below.

$Q_1 = \{\text{value of element whose cumulative frequency ratio is greater than or equal to } 1/4 \text{ and nearest to } 1/4\}$

$Q_3 = \{\text{value of element whose cumulative frequency ratio is greater than or equal to } 3/4 \text{ and nearest to } 3/4\}$

The following shows an actual example of the above. (Number of Elements: 10)

Data Value	Frequency	Cumulative Frequency	Cumulative Frequency Ratio
1	1	1	1/10 = 0.1
2	1	2	2/10 = 0.2
3	2	4	4/10 = 0.4
4	3	7	7/10 = 0.7
5	1	8	8/10 = 0.8
6	1	9	9/10 = 0.9
7	1	10	10/10 = 1.0

- 3 is the value whose cumulative frequency ratio is greater than or equal to 1/4 and nearest to 1/4, so  $Q_1 = 3$ .
- 5 is the value whose cumulative frequency ratio is greater than or equal to 3/4 and nearest to 3/4, so  $Q_3 = 5$ .

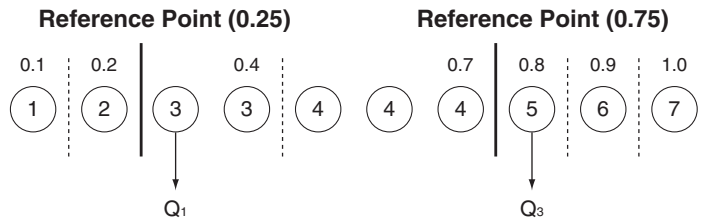

- Median is calculated using the same method as that used when the [Q<sub>1</sub>, Q<sub>3</sub> on Data] check box is unchecked.
- It makes no difference whether frequency values are all integers or include decimal fraction values when the [Q<sub>1</sub>, Q<sub>3</sub> on Data] check box is selected.

### • To display paired-variable calculation results

1. On the Stat Editor window or Stat Graph window, tap [Calc] - [Two-Variable].
2. On the dialog box that appears, specify the [XList] and [YList] names, select the [Freq] setting, and then tap [OK].
  - This displays the dialog box with the paired-variable statistical calculation results described below.

$\bar{x}, \bar{y}$ :	sample mean	$n$ :	sample size
$\Sigma x, \Sigma y$ :	sum of data	$\Sigma xy$ :	sum of products of XList and YList data
$\Sigma x^2, \Sigma y^2$ :	sum of squares	minX, minY:	minimum
$\sigma_x, \sigma_y$ :	population standard deviation	maxX, maxY:	maximum
$s_x, s_y$ :	sample standard deviation		

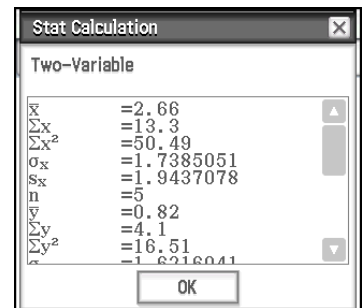

## Performing Regression Calculations

You can use the procedures under “Overlaying a Regression Graph on a Scatter Plot” (page 139) to specify a model formula, and determine and graph the regression formula for paired-variable data. The dialog box that appears when performing these operations provides the coefficients, constant term, and other values for the regression formula. You can also copy the regression formula to the Graph Editor window and perform residual calculation (which calculates the distance between the regression model and an actual plotted point during regression calculations).

### • To view regression calculation results

1. On the [Calc] - [Regression] menu, select one of the regression calculation commands (from [Linear Reg] to [Logistic Reg]).
  - For information about regression calculation characteristics, see “Regression graphs” (page 138).
2. On the dialog box that appears, specify the [XList] and [YList] names, and select the [Freq] setting.

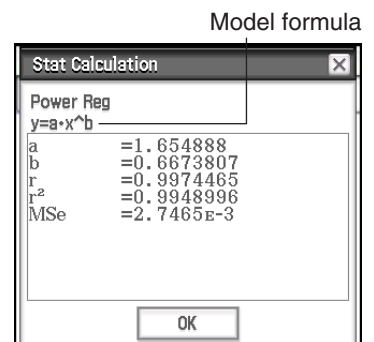

3. Tap [OK].

- This displays the dialog box with the regression calculation results described below.

$a, b, c, d, e$ : coefficients of the model formula (shown at the top of the dialog box) corresponding to the regression calculation

$r$ : correlation coefficient (linear regression, logarithmic regression, exponential regression, and power regression only)

$r^2$ : coefficient of determination (except for Med-Med, sinusoidal regression, and logistic regression)

$MSe$ : mean square error (except for Med-Med)

### ***MSe Formulas***

Depending on the regression calculation type, mean square error ( $MSe$ ) is obtained using the following formulas.

<b>Linear:</b>	$y = a \cdot x + b: \frac{1}{n-2} \sum_{i=1}^n (y_i - (ax_i + b))^2$	;	$y = a + b \cdot x: \frac{1}{n-2} \sum_{i=1}^n (y_i - (a + bx_i))^2$
<b>Quadratic:</b>	$\frac{1}{n-3} \sum_{i=1}^n (y_i - (ax_i^2 + bx_i + c))^2$		<b>Cubic:</b> $\frac{1}{n-4} \sum_{i=1}^n (y_i - (ax_i^3 + bx_i^2 + cx_i + d))^2$
<b>Quartic:</b>	$\frac{1}{n-5} \sum_{i=1}^n (y_i - (ax_i^4 + bx_i^3 + cx_i^2 + dx_i + e))^2$		<b>Logarithmic:</b> $\frac{1}{n-2} \sum_{i=1}^n (y_i - (a + b \ln x_i))^2$
<b>Exponential:</b>	$a \cdot e^{b \cdot x}: \frac{1}{n-2} \sum_{i=1}^n (\ln y_i - (\ln a + b x_i))^2$	;	$a \cdot b^x: \frac{1}{n-2} \sum_{i=1}^n (\ln y_i - (\ln a + (\ln b) \cdot x_i))^2$
<b>Power:</b>	$\frac{1}{n-2} \sum_{i=1}^n (\ln y_i - (\ln a + b \ln x_i))^2$		<b>Logistic:</b> $\frac{1}{n-2} \sum_{i=1}^n \left( y_i - \frac{C}{1 + ae^{-bx_i}} \right)^2$
<b>Sinusoidal:</b>	$\frac{1}{n-2} \sum_{i=1}^n (y_i - (a \cdot \sin(bx_i + c) + d))^2$		

### • To copy a regression formula to the Graph & Table application

1. Perform steps 1 and 2 under “To view regression calculation results” (page 143).
2. On the dialog box that appears, tap the [Copy Formula] down arrow button, and then select the Graph & Table line number (y1 through y20) to which you want to copy the formula.
3. Tap [OK].
  - This copies the calculated regression expression to the line (y1 through y20) you selected.

### • To perform residual calculation

1. Perform steps 1 and 2 under “To view regression calculation results” (page 143).
2. On the dialog box that appears, tap the [Copy Residual] down arrow button, and then select [On] or the list into which you want to copy the residual values.
3. Tap [OK].
  - This assigns residual data to a system variable named “residual” (and also to the list if you specify a list in step 2).
  - Values assigned to the “residual” system variable shows the vertical distances between actually plotted points and the regression model. A positive value indicates a plot that is higher than the regression model, while a negative value indicates a plot that is lower.

You can use the following procedure to view the current “residual” system variable values.

1. On the Stat Editor window, select any cell in the column where you want the list you will open to appear and then tap [Edit] - [Open List].
2. Enter “residual”, and then press **[EXE]**.



---

## Viewing the Results of the Last Statistical Calculation Performed (DispStat)

To view the results of the last statistical calculation performed using a [Calc] menu command\*, tap [Calc] - [DispStat].

\* Including test, confidence interval and distribution calculations.

## 7-4 Performing Advanced Statistical Calculations

You can perform test, confidence interval and distribution calculations using the wizard that you launch by tapping [Calc] on the menu bar.

---

### Performing Test, Confidence Interval and Distribution Calculations Using the Wizard

ClassPad includes built-in commands\* for performing test, confidence interval, and distribution calculations. The Statistics application lets you perform these types of calculations by simply inputting values and specifying required information in accordance with instructions displayed by a wizard. This eliminates the need to input commands and their arguments directly.

\* For information about command syntax, see “12-4 Program Command Reference”.

#### • ClassPad Operation

1. On the Stat Editor window, tap [Calc] and then tap [Test], [Interval], [Distribution] or [Inv. Distribution].
  - This displays the Wizard window in the lower half of the screen.
  - Selecting the [Help] check box causes the Wizard window to fill the display, and displays the description of the command.
2. On the Command menu, select the command you want to execute.
  - For information about what is calculated by each command, see “Tests” (page 146), “ConfidenceIntervals”(page 149), and “Distributions” (page 151).
3. Select “List” to use list data for calculation, or “Variable” to directly input values using a wizard.
  - Certain commands require data of a specific type (list, variable, or matrix) for calculation. For such commands, you will not be provided with a choice of data type options.

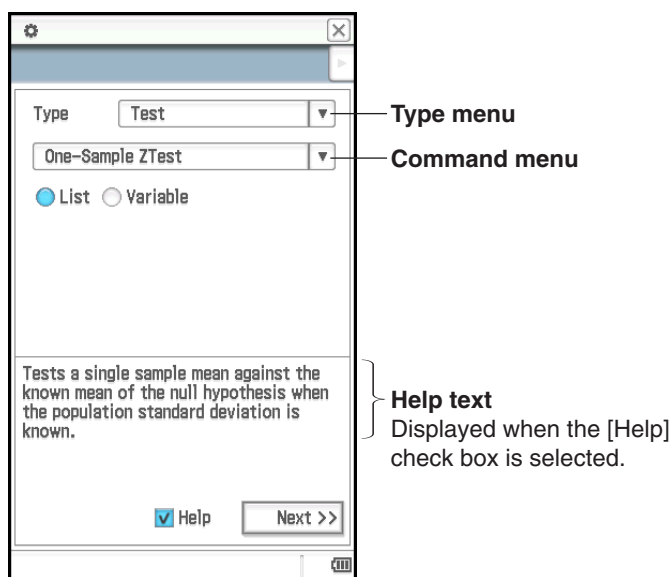

4. Tap [Next >>].
  - This displays a screen for specifying conditions and inputting values.
  - Initially, the top item on the screen will be selected, with help text about the top item shown at the bottom of the screen. Tapping another item will select it and display help text about it.
5. Input values and configure settings for each of the items on the screen.

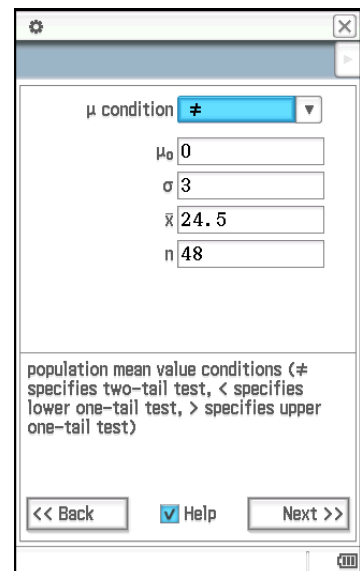

6. Tap [Next >>].
  - This displays the calculation results.
7. Tap  $\square$  to graph the results.
  - You cannot graph interval calculations and inverse distribution calculations.

**Tip:** You can back-step through the wizard by tapping [<< Back]. After returning to a previous screen you can change settings and values and recalculate results. Closing the wizard screen clears all settings and values.

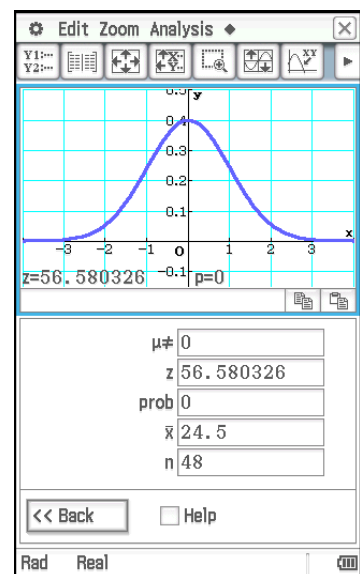
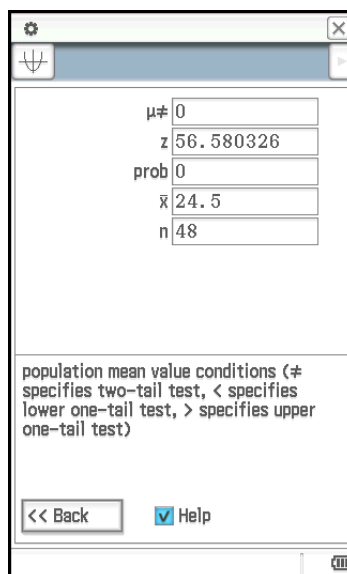

## Tests

The  $Z$  Test provides a variety of different tests based on standard deviation based tests. They make it possible to test whether or not a sample accurately represents the population when the standard deviation of a population (such as the entire population of a country) is known from previous tests. The  $t$  Test is used instead of the  $Z$  Test when the population standard deviation is unknown. You can also perform  $\chi^2$  Test, ANOVA (analysis of variance), and other test calculations.

The following describes the ClassPad commands for executing each type of statistical test calculation. It includes the calculation formula used and a general overview of each command.

### 1-Sample $Z$ Test .... [Test] - [One-Sample Z-Test] ..... $z = (\bar{x} - \mu_0)/(\sigma/\sqrt{n})$

Tests a single sample mean against the known mean of the null hypothesis when the population standard deviation is known. The normal distribution is used for the 1-Sample  $Z$  test.

**0702** To specify  $\mu \neq 0$ ,  $\sigma = 3$  for  $n$  (sample size) = 48,  $\bar{x}$  (sample mean) = 24.5 data and perform a 1-Sample  $Z$  Test

**0703** To specify  $\mu > 120$ ,  $\sigma = 19$  for the data in lists to the right (list1 = data, list2 = frequency) and perform a 1-Sample Z Test

list 1	list 2
120	1
125	2
130	4
135	1
140	1
145	1

**2-Sample Z Test** .... [Test] - [Two-Sample Z-Test] .....  $z = (\bar{x}_1 - \bar{x}_2) / \sqrt{(\sigma_1^2/n_1) + (\sigma_2^2/n_2)}$

Tests the difference between two means when the standard deviations of the two populations are known. The normal distribution is used for the 2-Sample Z test.

**1-Proportion Z Test** .... [Test] - [One-Prop Z-Test] .....  $z = (x/n - p_0) / \sqrt{p_0(1 - p_0)/n}$

Tests a single sample proportion against the known proportion of the null hypothesis. The normal distribution is used for the 1-Proportion Z test.

**2-Proportion Z Test** .... [Test] - [Two-Prop Z-Test] .....  $z = (x_1/n_1 - x_2/n_2) / \sqrt{\hat{p}(1 - \hat{p})(1/n_1 + 1/n_2)}$

Tests the difference between two sample proportions. The normal distribution is used for the 2-Proportion Z test.

**1-Sample t Test** .... [Test] - [One-Sample t-Test] .....  $t = (\bar{x} - \mu_0) / (s_x / \sqrt{n})$

Tests a single sample mean against the known mean of the null hypothesis when the population standard deviation is unknown. The  $t$  distribution is used for the 1-Sample  $t$  test.

**2-Sample t Test** .... [Test] - [Two-Sample t-Test]

Tests the difference between two means when the standard deviations of the two populations are unknown. The  $t$  distribution is used for the 2-Sample  $t$  test.

- When the two population standard deviations are equal (pooled)

$$t = (\bar{x}_1 - \bar{x}_2) / \sqrt{s_p^2(1/n_1 + 1/n_2)}$$

$$df = n_1 + n_2 - 2$$

$$s_p = \sqrt{((n_1 - 1)s_{x_1}^2 + (n_2 - 1)s_{x_2}^2) / (n_1 + n_2 - 2)}$$

- When the two population standard deviations are not equal (not pooled)

$$t = (\bar{x}_1 - \bar{x}_2) / \sqrt{s_{x_1}^2/n_1 + s_{x_2}^2/n_2}$$

$$df = 1 / (C^2/(n_1 - 1) + (1 - C)^2/(n_2 - 1))$$

$$C = (s_{x_1}^2/n_1) / (s_{x_1}^2/n_1 + s_{x_2}^2/n_2)$$

**Linear Regression t Test** .... [Test] - [Linear Reg t-Test] .....  $t = r\sqrt{(n - 2)/(1 - r^2)}$

$$b = \frac{\sum_{i=1}^n (x_i - \bar{x})(y_i - \bar{y})}{\sum_{i=1}^n (x_i - \bar{x})^2} \quad a = \bar{y} - b\bar{x}$$

$n$ : sample size ( $n \geq 3$ )

Tests the linear relationship between the paired variables ( $x, y$ ). The method of least squares is used to determine  $a$  and  $b$ , which are the coefficients of the regression formula  $y = a + bx$ . The  $p$ -value is the probability of the sample regression slope ( $b$ ) provided that the null hypothesis is true,  $\beta = 0$ . The  $t$  distribution is used for the linear regression  $t$  test.

---

$$\chi^2 \text{ Test (Chi-square Test) .... [Test] - } [\chi^2 \text{ Test}] \text{ .... } \chi^2 = \sum_{i=1}^k \sum_{j=1}^{\ell} \frac{(x_{ij} - F_{ij})^2}{F_{ij}}, \quad F_{ij} = \sum_{i=1}^k x_{ij} \times \sum_{j=1}^{\ell} x_{ij} / \sum_{i=1}^k \sum_{j=1}^{\ell} x_{ij}$$

Tests the independence of two categorical variables arranged in matrix form. The  $\chi^2$  test for independence compares the observed matrix to the expected theoretical matrix. The  $\chi^2$  distribution is used for the  $\chi^2$  test.

- The minimum size of the matrix is  $1 \times 2$ . An error occurs if the matrix has only one column.
- The result of the expected frequency calculation is stored in the system variable named "Expected".

**0704** To specify observed matrix:  $a = \begin{bmatrix} 11 & 68 & 3 \\ 9 & 23 & 5 \end{bmatrix}$  and perform a  $\chi^2$  test

---

**$\chi^2$  GOF Test (Chi-square Goodness-of-Fit Test) .... [Test] -  $[\chi^2$  GOF Test]**

$$\chi^2 = \sum_i^k \frac{(O_i - E_i)^2}{E_i} \quad \text{Contrib} = \left\{ \frac{(O_1 - E_1)^2}{E_1} \frac{(O_2 - E_2)^2}{E_2} \dots \frac{(O_k - E_k)^2}{E_k} \right\}$$

$O_i$ : The  $i$ -th element of the observed list,  $E_i$ : The  $i$ -th element of the expected list

Tests whether the observed count of sample data fits a certain distribution. For example, it can be used to determine conformance with normal distribution or binomial distribution.

**Tip:** The calculation results  $\chi^2$ ,  $p$ ,  $df$ , and Contrib are stored in the system variables named " $\chi^2$ value", "prob", "df", and "Contrib" respectively.

**0705** To specify observed list: list1 = {1,2,3}, expected list: list2 = {4,5,6}, and  $df = 1$ , and then perform a  $\chi^2$  test

---

**2-Sample  $F$  Test .... [Test] - [Two-Sample F-Test] .....**  $F = s_{x1}^2 / s_{x2}^2$

Tests the ratio between sample variances of two independent random samples. The  $F$  distribution is used for the 2-Sample  $F$  test.

---

**One-Way ANOVA (analysis of variance) .... [Test] - [One-Way ANOVA]**

Tests the hypothesis that the population means of multiple populations are equal. It compares the mean of one or more groups based on one independent variable or factor.

**0706** To use Factor A data of list1 = {7,4,6,6,5}, list2 = {6,5,5,8,7}, and list3 = {4,7,6,7,6}, and perform One-Way ANOVA

**Tip**

- To perform One-Way ANOVA using the wizard, you need to create up to six sets of list data (Factor A level 1 data, level 2 data, etc.). Specify the list data on the wizard screen and perform the calculation.
- One-Way ANOVA can also be performed using a program command (see the example **1209** under "Including Statistical Graphing and Calculation Functions in a Program" on page 225). To perform One-Way ANOVA using a program command, you need to create a "DependentList" that includes all Factor A level data (level1, level2, etc.) and a "FactorList(A)" that specifies the levels for each of the blocks of data in the DependentList. If you use the program command to perform the same test as shown in the example above, the two lists would be as shown below.

DependentList: {7,4,6,6,5,6,5,5,8,7,4,7,6,7,6} ... (All level 1, level 2, and level 3 data)

FactorList(A): {1,1,1,1,1,2,2,2,2,3,3,3,3,3} ... (Levels of each block of data)

---

## Two-Way ANOVA .... [Test] - [Two-Way ANOVA]

Tests the hypothesis that the population means of multiple populations are equal. It examines the effect of each variable independently as well as their interaction with each other based on a dependent variable.

**0707** The values in the table below are measurement results that show how the durability of a metal product is affected by changes in heat treatment time (A) and temperature (B). Experiments were conducted twice under each condition.

	Temperature B1	Temperature B2
Time A1	113, 116	139, 132
Time A2	133, 131	126, 122

Perform analysis of variance on the null hypotheses listed below, using a 5% level of significance.

H<sub>0</sub>: Change in time does not affect durability.

H<sub>0</sub>: Change in treatment temperature does not affect durability.

H<sub>0</sub>: Changes in time and treatment temperature do not affect durability.

Use the Two-Way ANOVA test to test the above hypotheses. Input the following measurement data into the indicated lists. This data is from the table above.

list1 = {113, 116} ... (Factor A1 × B1), list2 = {139, 132} ... (Factor A1 × B2)

list3 = {133, 131} ... (Factor A2 × B1), list4 = {126, 122} ... (Factor A2 × B2)

### Tip

- To perform Two-Way ANOVA using the wizard, you need to create list data in the quantity of data table vertical (number of Factor A levels) × horizontal (number of Factor B levels). Specify the list data on the wizard screen and perform the calculation. The dimensions that can be specified for Factor A × Factor B are shown in the screen to the right.

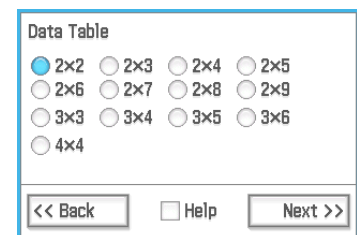

- Two-Way ANOVA can also be performed using a program command (see the example **1210** under “Including Statistical Graphing and Calculation Functions in a Program” on page 225). To perform Two-Way ANOVA using a program command, create a “DependentList” that includes all Factor A × Factor B level data, and “FactorList(A)” and “FactorList(B)” lists that specify the levels for each of the blocks of data in the DependentList. If you use the program command to perform the same test as shown in the example above, the three lists would be as shown below.

```
DependentList = {113,116,139,132,133,131,126,122}
```

```
FactorList(A) = { 1, 1, 1, 1, 2, 2, 2, 2 }
```

```
FactorList(B) = { 1, 1, 2, 2, 1, 1, 2, 2 }
```

---

## Confidence Intervals

A confidence interval is a range of values that has a specified probability of containing the parameter being estimated. A confidence interval that is too broad makes it difficult to get an idea of where the parameter (actual value) is located. A narrow confidence interval, on the other hand, limits the parameter range and makes it possible to obtain highly accurate results.

The commonly used confidence levels are 68%, 95% and 99%. With a confidence interval of 95%, for example, there is a 5% probability that a parameter will not be within the interval.

The following describes the ClassPad commands for executing each type of confidence interval calculation. It includes an overview of each command and the formulas to obtain the confidence interval lower limit (*Lower*) and upper limit (*Upper*).

---

**1-Sample Z Interval** .... [Interval] - [One-Sample Z Int]

$$\text{Lower, Upper} = \bar{x} \mp Z\left(\frac{\alpha}{2}\right) \frac{\sigma}{\sqrt{n}}$$

Calculates the confidence interval for the population mean based on a sample mean and known population standard deviation.

**0708** To specify the data below and perform a 1-Sample Z Interval calculation

list1: {299.4, 297.7, 301, 298.9, 300.2, 297}

Population standard deviation: 3

Significance level: 5% (= confidence level: 95%)

---

**2-Sample Z Interval** .... [Interval] - [Two-Sample Z Int]

$$\text{Lower, Upper} = (\bar{x}_1 - \bar{x}_2) \mp Z\left(\frac{\alpha}{2}\right) \sqrt{\frac{\sigma_1^2}{n_1} + \frac{\sigma_2^2}{n_2}}$$

Calculates the confidence interval for the difference between population means based on the difference between sample means when the population standard deviations are known.

---

**1-Proportion Z Interval** .... [Interval] - [One-Prop Z Int]

$$\text{Lower, Upper} = \frac{x}{n} \mp Z\left(\frac{\alpha}{2}\right) \sqrt{\frac{1}{n} \left(\frac{x}{n} \left(1 - \frac{x}{n}\right)\right)}$$

Calculates the confidence interval for the population proportion based on a single sample proportion.

---

**2-Proportion Z Interval** .... [Interval] - [Two-Prop Z Int]

$$\text{Lower, Upper} = \frac{x_1}{n_1} - \frac{x_2}{n_2} \mp Z\left(\frac{\alpha}{2}\right) \sqrt{\frac{\frac{x_1}{n_1} \left(1 - \frac{x_1}{n_1}\right)}{n_1} + \frac{\frac{x_2}{n_2} \left(1 - \frac{x_2}{n_2}\right)}{n_2}}$$

Calculates the confidence interval for the difference between population proportions based on the difference between two sample proportions.

---

**1-Sample t Interval** .... [Interval] - [One-Sample t Int]

$$\text{Lower, Upper} = \bar{x} \mp t_{n-1} \left(\frac{\alpha}{2}\right) \frac{s_x}{\sqrt{n}}$$

Calculates the confidence interval for the population mean based on a sample mean and a sample standard deviation when the population standard deviation is not known.

---

**2-Sample t Interval** .... [Interval] - [Two-Sample t Int]

Calculates the confidence interval for the difference between population means based on the difference between sample means and sample standard deviations when the population standard deviations are not known.

---

- When the two population standard deviations are equal (pooled)

$$\text{Lower, Upper} = (\bar{x}_1 - \bar{x}_2) \mp t_{n_1+n_2-2} \left(\frac{\alpha}{2}\right) \sqrt{s_p^2 \left(\frac{1}{n_1} + \frac{1}{n_2}\right)}$$

$$s_p = \sqrt{((n_1 - 1)s_{x_1}^2 + (n_2 - 1)s_{x_2}^2) / (n_1 + n_2 - 2)}$$

---

- When the two population standard deviations are not equal (not pooled)

$$\text{Lower, Upper} = (\bar{x}_1 - \bar{x}_2) \mp t_{df} \left(\frac{\alpha}{2}\right) \sqrt{\left(\frac{s_{x_1}^2}{n_1} + \frac{s_{x_2}^2}{n_2}\right)}$$

$$df = 1 / (C^2 / (n_1 - 1) + (1 - C)^2 / (n_2 - 1)) \quad C = (s_{x_1}^2 / n_1) / (s_{x_1}^2 / n_1 + s_{x_2}^2 / n_2)$$

---

**General Confidence Interval Precautions**

If you input a C-Level (confidence level) value in the range of  $0 \leq \text{C-Level} < 1$ , the value you input is used. To specify a C-Level of 95%, for example, input "0.95".

---

---

## Distributions

There is a variety of different types of distribution, but the most well-known is “normal distribution”, which is essential for performing statistical calculations. Normal distribution is a symmetrical distribution centered on the greatest occurrences of mean data (highest frequency), with the frequency decreasing as you move away from the center. Poisson distribution, geometric distribution, and various other distribution shapes are also used, depending on the data type.

**Tip:** Though list data can be used within the argument of a Distribution function (page 85), list data cannot be used in the argument of the Statistics Wizard operations described here.

The following describes the ClassPad commands for executing each type of distribution calculation. It includes the calculation formula used and a general overview of each command.

---

### Normal Probability Density .... [Distribution] - [Normal PD]

Calculates the normal probability density for a specified value.  
Specifying  $\sigma = 1$  and  $\mu = 0$  produces standard normal distribution.

$$f(x) = \frac{1}{\sqrt{2\pi}\sigma} e^{-\frac{(x-\mu)^2}{2\sigma^2}} \quad (\sigma > 0)$$

**0709** To calculate normal probability density for the data below and graph the result

Data: 37.5    Population standard deviation: 2    Population mean: 35

---

### Normal Cumulative Distribution .... [Distribution] - [Normal CD]

Calculates the cumulative probability of a normal distribution between a lower bound ( $a$ ) and an upper bound ( $b$ ).

$$p = \frac{1}{\sqrt{2\pi}\sigma} \int_a^b e^{-\frac{(x-\mu)^2}{2\sigma^2}} dx$$

**0710** To calculate normal cumulative distribution for the data below and graph the result

Lower bound:  $-\infty$                                       Upper bound: 36  
Population standard deviation: 2    Population mean: 35

---

### Inverse Normal Cumulative Distribution .... [Inv. Distribution] - [Inverse Normal CD]

Calculates the boundary value(s) of a normal cumulative probability distribution for specified values.

Tail: Left

$$\int_{-\infty}^{\alpha} f(x) dx = p$$

Upper bound  $\alpha$  is returned.

Tail: Right

$$\int_{\alpha}^{+\infty} f(x) dx = p$$

Lower bound  $\alpha$  is returned.

Tail: Center

$$\int_{\alpha}^{\beta} f(x) dx = p \quad \left( \mu = \frac{\alpha + \beta}{2} \right)$$

Lower bound  $\alpha$  and upper bound  $\beta$  are returned.

**0711** To calculate inverse normal cumulative distribution for the data below and graph the result

Tail: Left                                      Probability: 0.7  
Population mean: 35    Population standard deviation: 2

---

### Student's $t$ Probability Density .... [Distribution] - [Student's $t$ PD]

Calculates the Student's  $t$  probability density for a specified value.

$$f(x) = \frac{\Gamma\left(\frac{df+1}{2}\right)}{\Gamma\left(\frac{df}{2}\right)} \times \frac{\left(1 + \frac{x^2}{df}\right)^{-\frac{df+1}{2}}}{\sqrt{\pi \cdot df}}$$

### Student's $t$ Cumulative Distribution .... [Distribution] - [Student's $t$ CD]

Calculates the cumulative probability of a Student's  $t$  distribution between a lower bound ( $a$ ) and an upper bound ( $b$ ).

$$p = \frac{\Gamma\left(\frac{df+1}{2}\right)}{\Gamma\left(\frac{df}{2}\right) \sqrt{\pi \cdot df}} \int_a^b \left(1 + \frac{x^2}{df}\right)^{-\frac{df+1}{2}} dx$$

---

---

**Inverse Student's  $t$  Cumulative Distribution ....** [Inv. Distribution] - [Inverse  $t$  CD]

Calculates the lower bound value of a Student's  $t$  cumulative probability distribution for specified values.

$$\int_{\alpha}^{+\infty} f(x) = p$$

---

 **$\chi^2$  Probability Density ....** [Distribution] - [ $\chi^2$  PD]

Calculates the  $\chi^2$  probability density for a specified value.

$$f(x) = \frac{1}{\Gamma\left(\frac{df}{2}\right)} \times \left(\frac{1}{2}\right)^{\frac{df}{2}} x^{\frac{df}{2}-1} e^{-\frac{x}{2}}$$

---

 **$\chi^2$  Cumulative Distribution ....** [Distribution] - [ $\chi^2$  CD]

Calculates the cumulative probability of a  $\chi^2$  distribution between a lower bound and an upper bound.

$$p = \frac{1}{\Gamma\left(\frac{df}{2}\right)} \times \left(\frac{1}{2}\right)^{\frac{df}{2}} \int_a^b x^{\frac{df}{2}-1} e^{-\frac{x}{2}} dx$$

---

**Inverse  $\chi^2$  Cumulative Distribution ....** [Inv. Distribution] - [Inverse  $\chi^2$  CD]

Calculates the lower bound value of a  $\chi^2$  cumulative probability distribution for specified values.

$$\int_{\alpha}^{+\infty} f(x) = p$$

---

 **$F$  Probability Density ....** [Distribution] - [ $F$  PD]

Calculates the  $F$  probability density for a specified value.

$$f(x) = \frac{\Gamma\left(\frac{n+d}{2}\right)}{\Gamma\left(\frac{n}{2}\right)\Gamma\left(\frac{d}{2}\right)} \times \left(\frac{n}{d}\right)^{\frac{n}{2}} x^{\frac{n}{2}-1} \times \left(1 + \frac{n \cdot x}{d}\right)^{-\frac{n+d}{2}}$$

---

 **$F$  Cumulative Distribution ....** [Distribution] - [ $F$  CD]

Calculates the cumulative probability of an  $F$  distribution between a lower bound and an upper bound.

$$p = \frac{\Gamma\left(\frac{n+d}{2}\right)}{\Gamma\left(\frac{n}{2}\right)\Gamma\left(\frac{d}{2}\right)} \times \left(\frac{n}{d}\right)^{\frac{n}{2}} \int_a^b x^{\frac{n}{2}-1} \times \left(1 + \frac{n \cdot x}{d}\right)^{-\frac{n+d}{2}} dx$$

---

**Inverse  $F$  Cumulative Distribution ....** [Inv. Distribution] - [Inverse  $F$  CD]

Calculates the lower bound value of an  $F$  cumulative probability distribution for specified values.

$$\int_{\alpha}^{+\infty} f(x) = p$$

---

**Binomial Distribution Probability ....** [Distribution] - [Binomial PD]

Calculates the probability in a binomial distribution that success will occur on a specified trial.

$$f(x) = {}_n C_x p^x (1-p)^{n-x} \quad (x = 0, 1, \dots, n)$$

$p$ : probability of success ( $0 \leq p \leq 1$ )  
 $n$ : number of trials

---

**Binomial Cumulative Distribution ....** [Distribution] - [Binomial CD]

Calculates the cumulative probability in a binomial distribution that success will occur on or before a specified trial.

---

**Inverse Binomial Cumulative Distribution ....** [Inv. Distribution] - [Inverse Binomial CD]

Calculates the minimum number of trials of a binomial cumulative probability distribution for specified values.

$$\sum_{x=0}^m f(x) \geq prob$$

---

**Poisson Distribution Probability ....** [Distribution] - [Poisson PD]

Calculates the probability in a Poisson distribution that success will occur on a specified trial.

$$f(x) = \frac{e^{-\lambda} \lambda^x}{x!}$$

$(x = 0, 1, 2, \dots)$   
 $\lambda$ : mean ( $0 < \lambda$ )

**0712** To calculate Poisson probability for the data below and graph the result

Specified trial: 10      Mean: 6



---

**Poisson Cumulative Distribution ....** [Distribution] - [Poisson CD]

Calculates the cumulative probability in a Poisson distribution that success will occur on or before a specified trial.

**0713** To calculate Poisson cumulative probability for the data below and graph the result

Lower bound: 2    Upper bound: 3    Mean: 2.26

---

**Inverse Poisson Cumulative Distribution ....** [Inv. Distribution] - [Inverse Poisson CD]

Calculates the minimum number of trials of a Poisson cumulative probability distribution for specified values.

$$\sum_{x=0}^m f(x) \geq prob$$

**0714** To calculate inverse Poisson cumulative distribution for the data below and graph the result

Poisson cumulative probability: 0.8074    Mean: 2.26

---

**Geometric Distribution Probability ....** [Distribution] - [Geometric PD]

Calculates the probability in a geometric distribution that the success will occur on a specified trial.

$$f(x) = p(1-p)^{x-1}$$

$(x = 1, 2, 3, \dots)$   
 $p$ : probability of success  $(0 \leq p \leq 1)$

---

**Geometric Cumulative Distribution ....** [Distribution] - [Geometric CD]

Calculates the cumulative probability in a geometric distribution that the success will occur on or before a specified trial.

---

**Inverse Geometric Cumulative Distribution ....** [Inv. Distribution] - [Inverse Geo CD]

Calculates the minimum number of trials of a geometric cumulative probability distribution for specified values.

$$\sum_{x=1}^m f(x) \geq prob$$

---

**Hypergeometric Distribution Probability ....** [Distribution] - [Hypergeometric PD]

Calculates the probability in a hypergeometric distribution that the success will occur on a specified trial.

$$prob = \frac{{}^M C_x \times {}^{N-M} C_{n-x}}{{}^N C_n}$$

---

**Hypergeometric Cumulative Distribution ....** [Distribution] - [Hypergeometric CD]

Calculates the cumulative probability in a hypergeometric distribution that the success will occur on or before a specified trial.

$$prob = \sum_{i=Lower}^{Upper} \frac{{}^M C_i \times {}^{N-M} C_{n-i}}{{}^N C_n}$$

---

**Inverse Hypergeometric Cumulative Distribution ....** [Inv. Distribution] - [Inverse Hypergeometric]

Calculates the minimum number of trials of a hypergeometric cumulative probability distribution for specified values.

$$prob \leq \sum_{i=0}^x \frac{{}^M C_i \times {}^{N-M} C_{n-i}}{{}^N C_n}$$

---

---

## Input and Output Terms

### ■ Input Terms

**C-Level:** confidence level ( $0 \leq \text{C-Level} < 1$ )

**Contrib:** name of list specifying the contribution of each observed count

**df:** degrees of freedom

**Expected:** name of list that is for saving expected frequency

**Freq, Freq(1), Freq(2):** frequency (1 or list name)

**List, List(1), List(2):** list where sample data is located

**Lower (Distribution):** lower bound

**M:** number of success in population\*<sup>1</sup>

**Matrix ( $\chi^2$  Test):** name of matrix containing observed values\*<sup>2</sup>

**n (Hypergeometric Distribution):** number of trials from population\*<sup>1</sup>

**n:** sample size\*<sup>1</sup>

**n<sub>1</sub> / n<sub>2</sub>:** size of {sample 1 / sample 2}\*<sup>1</sup>

**N:** population size (integer,  $n \leq N$ ,  $M \leq N$ )

**Numtrial:** number of trials  $n$ \*<sup>1</sup>

**Observed ( $\chi^2$  GOF Test):** name of list containing observed counts (all cells positive integers)

**Observed ( $\chi^2$  Test):** name of matrix containing observed values\*<sup>2</sup>

**p<sub>0</sub>:** expected sample proportion ( $0 < p_0 < 1$ )

**p<sub>1</sub> condition (2-Proportion Z Test):** sample proportion test conditions\*<sup>3</sup>

**Pooled:** pooling On or Off

**pos:** probability of success  $p$  ( $0 \leq p \leq 1$ )

**prob (Inv. Distribution):** cumulative probability value ( $0 \leq \text{prob} \leq 1$ )

**Prop condition (1-Proportion Z Test):** sample proportion test conditions\*<sup>4</sup>

\*<sup>1</sup> positive integer

\*<sup>2</sup> positive integers in all cells for  $2 \times 2$  and larger matrices; positive real numbers for one row matrices

\*<sup>3</sup> “≠” specifies two-tail test, “<” specifies one-tail test where sample 1 is smaller than sample 2, “>” specifies one-tail test where sample 1 is greater than sample 2.

\*<sup>4</sup> “≠” specifies two-tail test, “<” specifies lower one-tail test, “>” specifies upper one-tail test.

**s<sub>x</sub>:** sample standard deviation ( $0 < s_x$ )

**s<sub>x1</sub> / s<sub>x2</sub>:** sample standard deviation of {sample 1 / sample 2} ( $0 < s_{x1}$ ,  $0 < s_{x2}$ )

**Upper (Distribution):** upper bound

**x (1-Proportion Z Test):** sample value\*<sup>1</sup>

**x (1-Proportion Z Interval):** data value\*<sup>1</sup>

**x (Binomial PD):** specified trial (integer,  $0 \leq x \leq n$ )

**x (Poisson PD, Geometric PD, Hypergeometric PD):** specified trial\*<sup>1</sup>

**x (Other than the above):** data value

**$\bar{x}$ :** sample mean

**$\bar{x}_1$  /  $\bar{x}_2$ :** sample mean of {sample 1 data / sample 2 data}

**x<sub>1</sub> / x<sub>2</sub> (1-Proportion Z Interval):** data value of {sample 1 / sample 2} (integer,  $0 \leq x_1$ ,  $0 \leq x_2$ )

**XList / YList:** x-data list / y-data list

**$\beta$  &  $\rho$  condition (LinearReg  $t$  Test):**  $\beta$  and  $\rho$ -value test conditions\*<sup>4</sup>

**$\lambda$ :** mean ( $0 < \lambda$ )

**$\mu$  (Distribution):** population mean

**$\mu$  condition (1-Sample Z Test, 1-Sample  $t$  Test):** population mean value test conditions\*<sup>4</sup>

**$\mu_0$ :** assumed population mean

**$\mu_1$  (2-Sample Z Test):** population mean value test conditions\*<sup>3</sup>

**$\mu_1$  (2-Sample  $t$  Test):** sample mean value test conditions\*<sup>3</sup>

**$\sigma$ :** population standard deviation ( $0 < \sigma$ )

**$\sigma_1$  condition (2-Sample  $F$  Test):** population standard deviation test conditions\*<sup>3</sup>

**$\sigma_1$  /  $\sigma_2$ :** population standard deviation of {sample 1 / sample 2} ( $0 < \sigma_1$  /  $0 < \sigma_2$ )

## ■ Output Terms

$a$ : regression constant term ( $y$ -intercept)

**A  $df$** :  $df^{*5}$  of Factor A

**A  $F$** :  $F$  value of Factor A

**A  $MS$** :  $MS^{*6}$  of Factor A

**A  $p$** :  $p$ -value of Factor A

**A  $SS$** :  $SS^{*7}$  of Factor A

**AB  $df^{*8}$** :  $df^{*5}$  of Factor A  $\times$  Factor B

**AB  $F^{*8}$** :  $F$  value of Factor A  $\times$  Factor B

**AB  $MS^{*8}$** :  $MS^{*6}$  of Factor A  $\times$  Factor B

**AB  $p^{*8}$** :  $p$ -value of Factor A  $\times$  Factor B

**AB  $SS^{*8}$** :  $SS^{*7}$  of Factor A  $\times$  Factor B

$b$ : regression coefficient (slope)

**B  $df$** :  $df^{*5}$  of Factor B

**B  $F$** :  $F$  value of Factor B

**B  $MS$** :  $MS^{*6}$  of Factor B

**B  $p$** :  $p$ -value of Factor B

**B  $SS$** :  $SS^{*7}$  of Factor B

$d:df$ : degrees of freedom of denominator (positive integer)

$df$ : degrees of freedom

**Err $df$** :  $df^{*5}$  of error

**Err $MS$** :  $MS^{*6}$  of error

**Err $SS$** :  $SS^{*7}$  of error

$F$ :  $F$  value

**Lower**: confidence interval lower limit

$n:df$ : degrees of freedom of numerator (positive integer)

$\hat{p}$ : estimated sample proportion

$\hat{p}_1 / \hat{p}_2$ : estimated proportion of {sample 1 / sample 2}

**$prob$**  (Binomial PD, Poisson PD, Geometric PD, Hypergeometric PD): probability

\*5 degrees of freedom

\*6 mean square

\*7 sum of squares

\*8 Note that “AB  $df$ ”, “AB  $MS$ ”, “AB  $SS$ ”, “AB  $F$ ”, and “AB  $p$ ” are not displayed in the calculation result window if there are no repeated data pairs.

\*9 In the calculation result window for certain distributions, “\* $xInv$ ” is displayed only when there may be a possibility of rounding error. To account for possible rounding error, ClassPad additionally obtains the result using the probability that is next lowest for the least significant digit. For example, if the probability is 0.61, ClassPad would recalculate using 0.60. The recalculation result is only shown if it is different from the original one.

**$prob$**  (Binomial CD, Poisson CD, Geometric CD, Hypergeometric CD): cumulative probability

**$prob$**  (Normal PD, Student's  $t$  PD,  $\chi^2$  PD, F PD): probability density

**$prob$**  (Normal CD, Student's  $t$  CD,  $\chi^2$  CD, F CD): distribution probability

**$prob$**  (Test):  $p$  value

$r$ : correlation coefficient

$r^2$ : coefficient of determination

$s_x$ : sample standard deviation

$s_{x1} / s_{x2}$ : sample standard deviation of {sample 1 / sample 2} (Displayed only for list format.)

$s_p$ : pooled sample standard deviation

$se$ : standard error of estimation

**SE $b$** : standard error of the least squares slope

$t$ :  $t$  value

**$t$  Low**: lower bound value you input

**$t$  Up**: upper bound value you input

**Upper**: confidence interval upper limit

**$x_1InvN$** : Upper bound when Tail:Left, Lower bound when Tail:Right or Tail:Center

**$x_2InvN$** : Upper bound when Tail:Center

**$xInv$** : inverse cumulative distribution

\* **$xInv$** : recalculation value of inverse cumulative distribution\*<sup>9</sup>

$z$ :  $z$  value

**$z$  Low**: standardized lower limit  $z$  value

**$z$  Up**: standardized upper limit  $z$  value

$\chi^2$ :  $\chi^2$  value



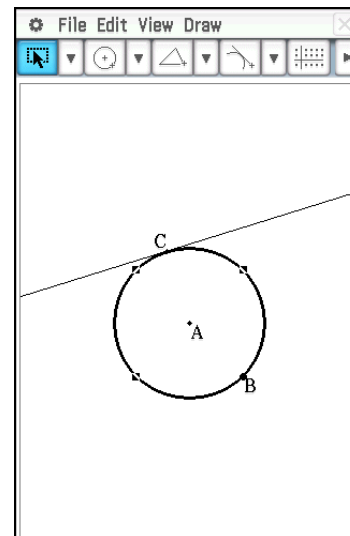

# Chapter 8: Geometry Application

The Geometry application allows you to draw and analyze geometric figures. For example, you can draw a circle and then draw a line that is tangent to a particular point on the circle. The Geometry application also includes an animation feature that lets you watch how a figure changes in accordance with conditions you define.



Starting up the Geometry application displays a large white Geometry window. Use this window to draw the figures you want. If you left figures on the Geometry window the last time you exited the Geometry application, those figures will appear the next time you start it up.



## Geometry Application-Specific Menus and Buttons

- Clear all settings fixed with the measurement box.....Edit - Clear Constraints
  - Show hidden objects..... Edit - Show All
  - Specify the color of the currently selected object..... Edit - Style
  - Hide the currently selected object..... Edit - Properties - Hide
  - Show hidden names ..... Edit - Properties - Show Name
  - Hide the selected name ..... Edit - Properties - Hide Name
  - Move the selected object to the front or to the back .....Edit - Properties - To the front / To the back
  - Move all text to the front..... Edit - Properties - All Text
  - Pin an annotation position on the Geometry window.....Edit - Properties - Pin
  - Unpin an annotation on the Geometry window ..... Edit - Properties - Unpin
  - Specify the number format for each measurement used in the Geometry window .....Edit - Properties - Number Format
  - Display the Animate submenu (page 174)..... Edit - Animate
- 
- Select a segment, line, or part of a figure (page 167).....View - Select or 
  - Activate the pan function for dragging the Geometry window with the stylus ..... View - Pan or 
  - Adjust the size of the display image so it fills the display..... View - Zoom to Fit or 
  - Turn display of axes, coordinate values and grid on or off .....View - Toggle Axes or 
  - Show grid points (On) or hide the grid (Off) ..... View - Grid - On / Off
  - Show grid lines..... View - Grid - Line
  - Turn the Animation toolbar on or off ..... View - Animation UI
- 
- Display a submenu for plotting points, and drawing lines and other basic figures (pages 157 through 159) ..... Draw - Basic Object

- Display a submenu for drawing a figure of specially shaped figures such as triangles and rectangles (page 162) ..... Draw - Special Polygon
  - Display a submenu for drawing functions (page 160)..... Draw - Function
  - Insert a value or text connected with a displayed figure into the display (pages 161 through 162) ..... Draw - Text / Attached Angle / Measurement / Expression
  - Display a slider (page 172) for the currently selected object. .... Draw - Slider
  - Display a submenu for geometric constructions (page 163)..... Draw - Construct
- 
- Activate Toggle Select (page 167)..... Tap  and then tap a figure

**Tip:** The View menu Zoom Box () , Zoom In () , and Zoom Out () commands are the same as the Graph & Table application Box, Zoom In, and Zoom Out commands on the Zoom menu. For more information about these commands, see “Chapter 3: Graph & Table Application”.

## Configuring Geometry View Window Settings

You can use the following procedures to configure settings that control the appearance of the Geometry application window.

Tap , and then [View Window] to display the View Window dialog box. The View Window dialog box allows you to configure the  $x$ -axis range of values. The  $y_{mid}$  value is used to center the Geometry window vertically. For example, if we set  $y_{mid} = 2$ , the  $y$ -axis will appear 2 units below the center of the Geometry window.

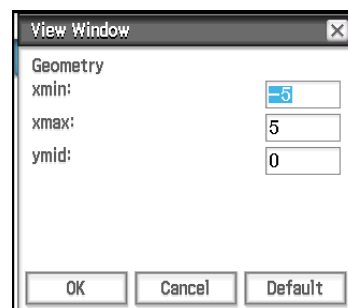

The following are the allowable ranges for the indicated View Window parameters.

$$-1 \times 10^6 \leq x_{min} \leq 1 \times 10^6 \qquad -1 \times 10^6 \leq x_{max} \leq 1 \times 10^6$$

$$-1 \times 10^6 \leq y_{mid} \leq 1 \times 10^6 \qquad x_{max} - x_{min} \geq 1 \times 10^{-4}$$

## About the Geometry Format Dialog Box

Settings for the Geometry application can be configured on the Geometry Format dialog box which appears when you tap  and then [Geometry Format]. See “1-7 Configuring Application Format Settings” for more information.

# 8-1 Drawing Figures

This section explains how to use the Geometry application to draw various types of figures. It also explains how to use the geometric construction tools to investigate theorems and properties in Geometry.

## Drawing a Figure

### • To plot a point

1. Tap [Draw] - [Basic Object] - [Point], or tap .
2. Tap the location on the screen where you want to plot a point.

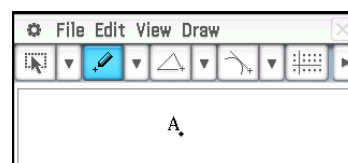

### • To draw a line segment

1. Tap [Draw] - [Basic Object] - [Line Segment], or tap .
2. Tap the screen where you want the line segment to begin, and a point will be drawn, and then tap the point where you want it to end.

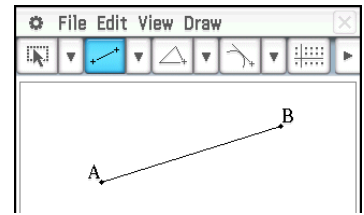

### • To add a labeled point to an existing line

1. Tap [Draw] - [Basic Object] - [Point], or tap .
2. Drag the stylus to the location on the line where you want to add a labeled point, and then lift the stylus from the screen.

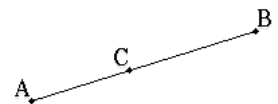

### • To draw an infinite line

1. Tap [Draw] - [Basic Object] - [Infinite Line], or tap .
2. Tap two points on the screen through which you want the infinite line to pass.

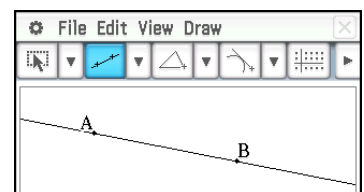

### • To draw a ray

1. Tap [Draw] - [Basic Object] - [Ray], or tap .
2. Tap two points on the screen, or tap one point and then drag to the second point.

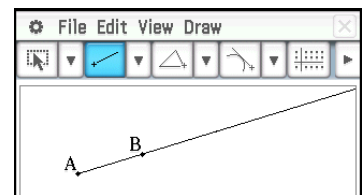

### • To draw a vector

1. Tap [Draw] - [Basic Object] - [Vector], or tap .
2. Tap the point where you want the vector to start, and then its end point.

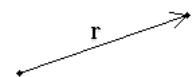

### • To draw a circle

1. Tap [Draw] - [Basic Object] - [Circle], or tap .
2. Tap the point where you want the center of the circle to be, and then tap a second point anywhere on the circle's circumference.

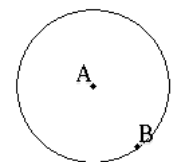

### • To draw an arc

1. Tap [Draw] - [Basic Object] - [Arc], or tap .
2. Tap the point where you want the center of the arc to be, and then tap a second point to designate where you want the arc to start.
3. Tap a third point, which is where you want the arc to end.

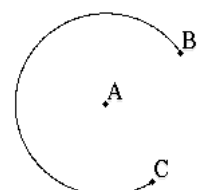

• **To draw an ellipse**

1. Tap [Draw] - [Basic Object] - [Ellipse] - [Axes], or tap .
2. Tap the point you want to specify as the center point.
3. Tap or drag to the point you want to specify as minor axis (nearest point on the edge from the center point).
4. Tap or drag to the point you want to specify as major axis (farthest point on the edge from the center point).

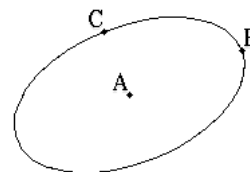

(Or)

1. Tap [Draw] - [Basic Object] - [Ellipse] - [Foci], or tap .
2. Tap the two points that you want to specify as the foci of the ellipse (point 1 and point 2).
  - This causes a line to appear between point 1 and point 2.
3. Tap the point you want to specify as a point anywhere on the ellipse (point 3).
  - This draws an ellipse whose line passes through point 3, using point 1 and point 2 as foci.

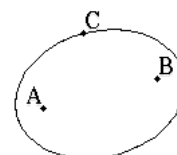

• **To draw a hyperbola**

1. Tap [Draw] - [Basic Object] - [Hyperbola], or tap .
2. Tap the two points that you want to specify as the foci of the hyperbola (point 1 and point 2).
  - This causes a line to appear between point 1 and point 2.
3. Tap the point you want to specify as a point anywhere on the hyperbola (point 3).
  - This draws a hyperbola whose line passes through point 3, using point 1 and point 2 as foci.

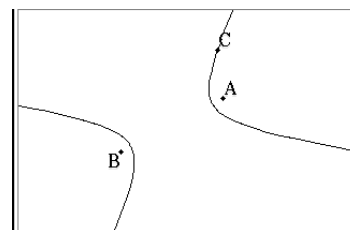

• **To draw a parabola**

1. Tap [Draw] - [Basic Object] - [Parabola], or tap .
2. Tap the two points that you want to specify the directrix (point 1 and point 2).
  - This causes a line to appear between point 1 and point 2.
3. Tap the point you want to specify as the focus (point 3).
  - This draws a parabola using the straight line that passes through point 1 and point 2 as the directrix, and point 3 as the focus.

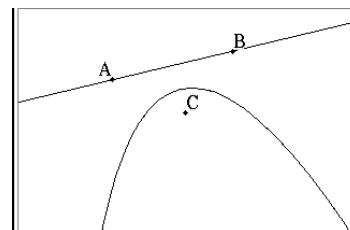

• **To draw a polygon**

1. Tap [Draw] - [Basic Object] - [Polygon], or tap .
2. Tap the point from which you want the polygon to start.
3. Sequentially tap each of the vertices of the polygon.
4. Finally, tap the start point again to complete the polygon.

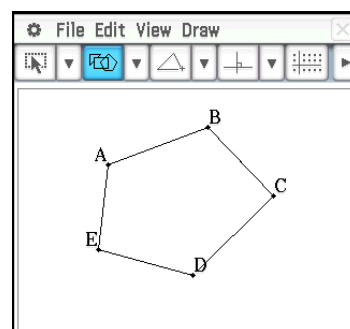
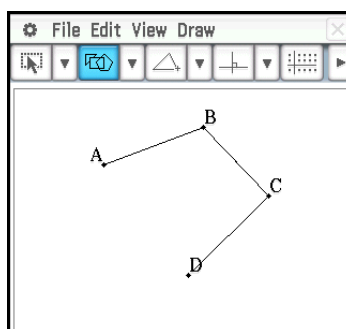

• **To draw a function**

1. Tap [Draw] - [Function] - [ $f(x)$ ].
  - Or you could tap  $y=f(x)$  on the tool bar. Next on the Function dialog box that appears, use the Type box to select " $f(x)$ ".
2. On the Function dialog box, input the function and then tap [OK] to draw it.

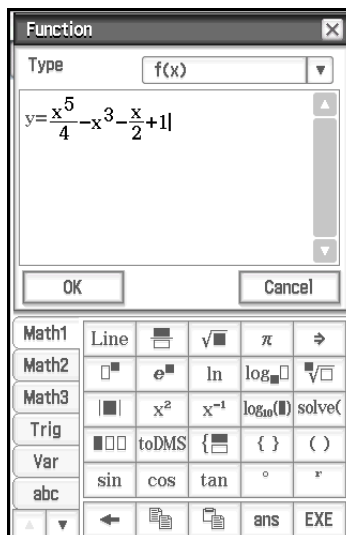

• **To draw a polar equation graph\***

1. Tap [Draw] - [Function] - [Polar].
  - Or you could tap  $y=f(x)$  on the tool bar. Next on the Function dialog box that appears, use the Type box to select "Polar".
2. On the Function dialog box, input an expression in the syntax of  $r = f(\theta)$ , the lower limit of  $\theta$  ( $\theta_{min}$ ) and its upper limit ( $\theta_{max}$ ).
3. Tap [OK] to draw the polar equation graph.

\* In this example, the [Function Angle] setting of the Geometry Format dialog box (page 40) is set to "Radian".

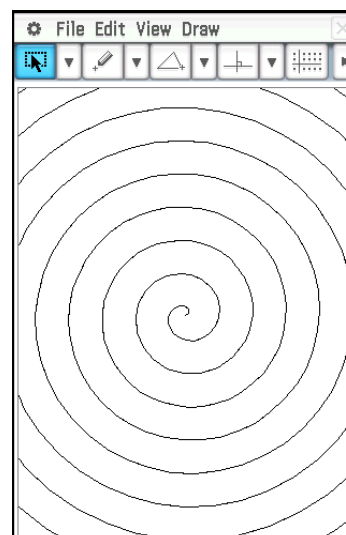
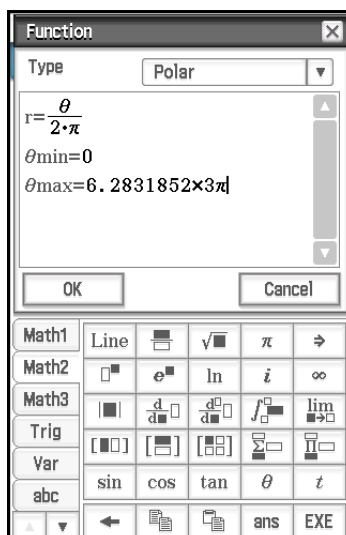

• **To draw a parametric equation graph\***

1. Tap [Draw] - [Function] - [Parametric].
  - Or you could tap  $y=f(x)$  on the tool bar. Next on the Function dialog box that appears, use the Type box to select "Parametric".
2. On the Function dialog box, input expressions and values.
3. Tap [OK] to draw the parametric equation graph.

\* In this example, the [Function Angle] setting of the Geometry Format dialog box (page 40) is set to "Radian".

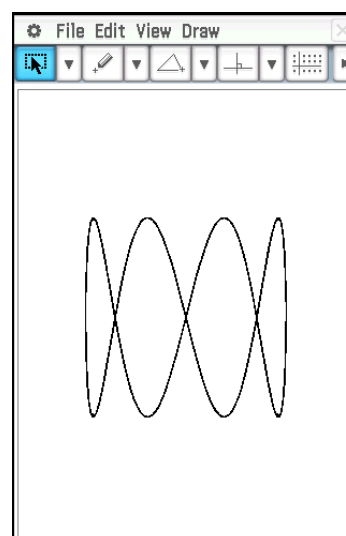
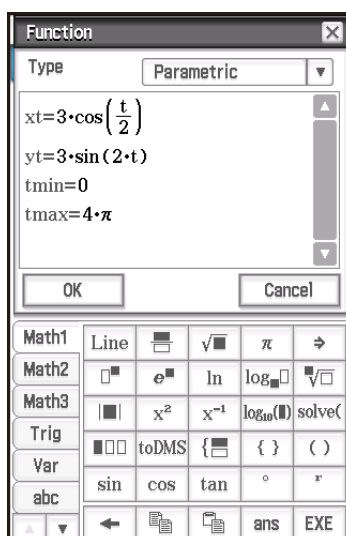



## Inserting Text Strings into the Screen

You can insert text strings into the screen while working on the Geometry application window. To do so, tap [Text] on the [Draw] menu. On the dialog box that appears, input the text you want, and then tap [OK].

## Attaching an Angle Measurement to a Figure

The measurement of an angle formed by two sides of a figure can be attached to the figure as shown here. To do so, tap [Attached Angle] on the [Draw] menu.

### • To attach an angle measurement to a figure

**Example:** To attach the measurement of angle A in triangle ABC

1. Draw the triangle.
2. Tap . Next, tap side AB and then side AC to select them.
3. Tap [Draw] and then [Attached Angle].
  - This attaches the angle measurement to the figure.

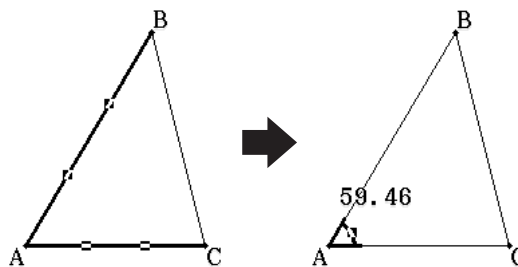

**Tip:** The two sides of the figure actually form four angles in the illustration shown here. After attaching an angle measurement using the [Attached Angle] command, you can drag it to the position of any one of the other three angles as shown in the example below.

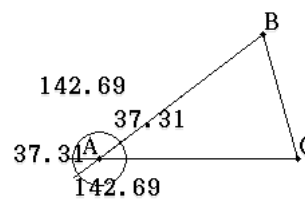

**Example:** To drag the angle measurement attached to interior angle A of triangle ABC to its exterior supplementary angle

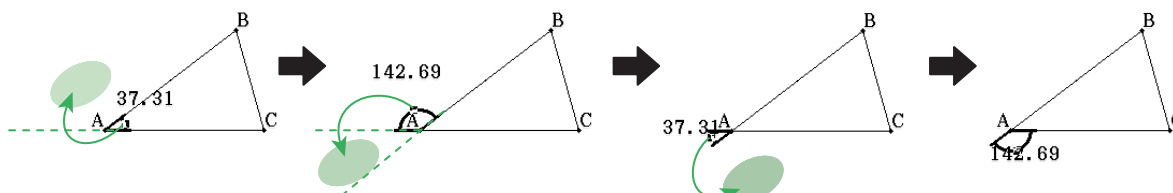

## Displaying the Measurements of a Figure

You can display measurements on the Geometry application window. The measurements change dynamically as you manipulate the figure.

### • To display a measurement of a figure

1. What you should select (point, line, figure, etc.) depends on the type of measurement you want to display.

To display this type of measurement:	Select this:
Angle between two lines	Two lines (Any two of the following: line segment, infinite line, ray, or vector, one side of a polygon)
Supplementary angle of extended lines	
Area of selected figure	<ul style="list-style-type: none"> <li>• All the sides or all the apexes of a polygon</li> <li>• The circumference of a circle, ellipse, or arc</li> </ul>
Circumference or perimeter of selected figure	<ul style="list-style-type: none"> <li>• Three points</li> </ul>

To display this type of measurement:	Select this:
Coordinates of selected point	Any single point (including the apex of a polygon)
Direction of line or vector	A single line (line segment, infinite line, ray, vector, or any side of a polygon)
Equation of selected curve	Any line or curve
Distance between two points, or length of line	Any two points, a line segment, or any side of a polygon
Radius of circle or arc	The radius of the circle or arc
Slope of line or vector	A single line (line segment, infinite line, ray, vector, or any side of a polygon)

2. Perform any one of the following operations.

- Tap [Draw] - [Measurement]. On the submenu that appears, select the measurement type you want to display on the screen.
- Select the value in the measurement box and drop it directly into the Geometry application window.
- Tap the measurement icon button to the left of the measurement box.

**Tip:** For information about the measurement box, see “8-3 Using the Measurement Box”.

**0801** To display the interior angle formed by two sides of a triangle

## Displaying the Result of a Calculation that Uses On-screen Measurement Values

You can use the [Expression] command and the commands on the [Measurement] submenu to perform calculations using the angle value, line length, surface area, and other measurement values attached to a figure, and display the result on the Geometry window.

### • To display the result of a calculation that uses on-screen measurement values

**0802** To display the sum of the interior angles of triangle ABC ( $\angle A + \angle B + \angle C$ )

## Using the Special Polygon Submenu

The [Special Polygon] submenu allows you to draw specially shaped figures automatically. Simply select the type of figure you want from the menu, and then touch the screen with the stylus to draw it. Or, touch the screen with your stylus and drag to create a box indicating the size of the figure you would like to draw.

Each of the [Special Polygon] submenu figures is also available on the toolbar.

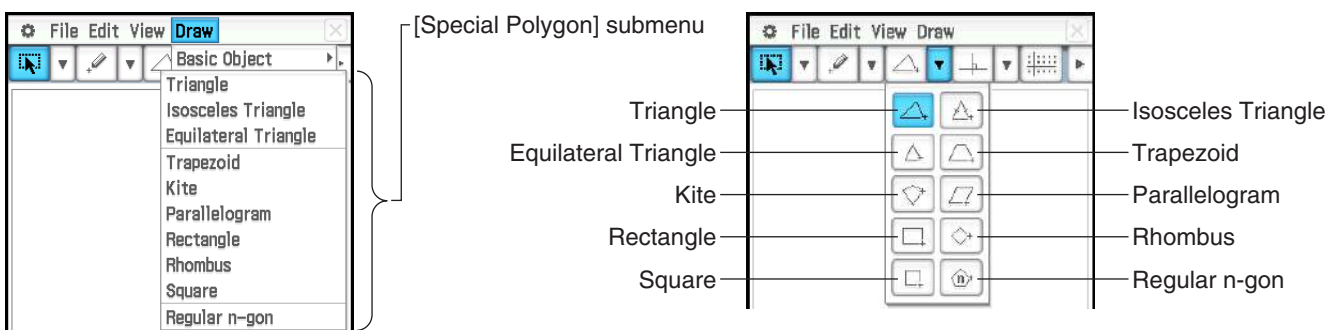

• **To draw a triangle**

1. Tap [Draw], [Special Polygon], and then [Triangle].
2. Place the stylus on the screen and drag diagonally in any direction.
  - This causes a selection boundary to appear, indicating the size of the triangle that will be drawn. The triangle is drawn when you release the stylus.
  - In place of the above step 2, you can achieve the same result by simply tapping the screen. This automatically draws the acute triangle you selected.

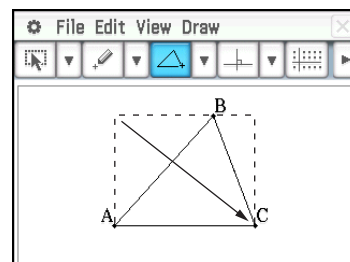

**0803** To draw a regular polygon

**Using the Construct Submenu**

The [Construct] submenu provides you with the means to study various geometric theorems. Each of the [Construct] submenu figures is also available on the toolbar.

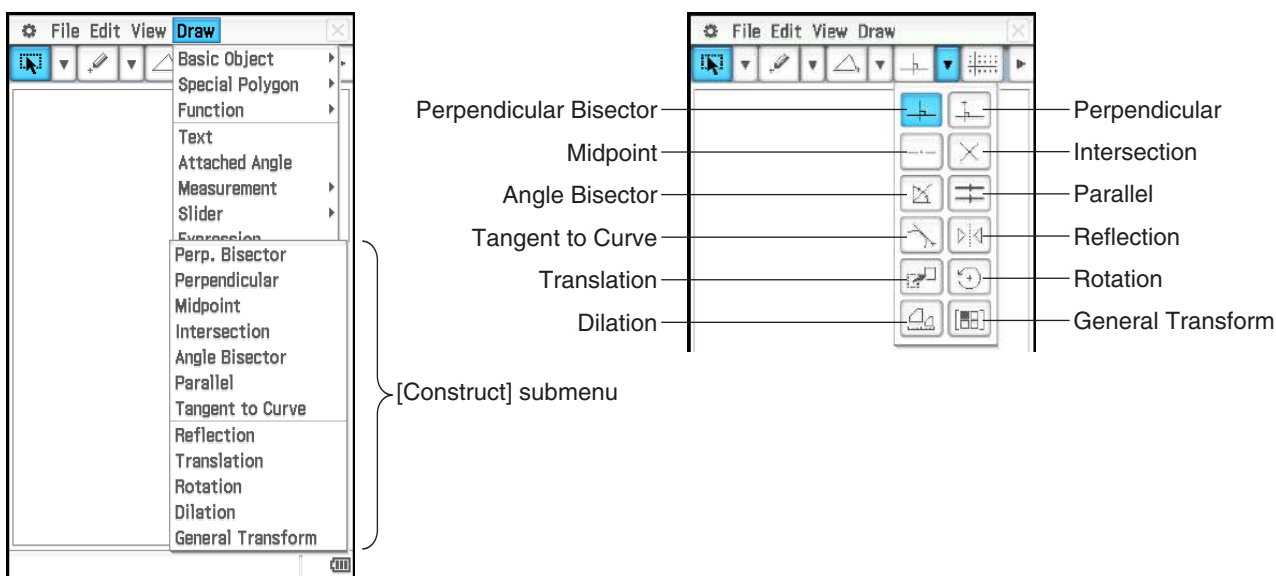

The following procedures include steps that require selection of a line segment or other figures. For details about selecting figures, see “8-2 Editing Figures”.

• **To construct a perpendicular bisector**

1. Draw a line segment.
2. Tap [Select], and then select the line segment.
3. Tap [Draw], [Construct], and then [Perp. Bisector]. This draws a perpendicular bisector through your line segment.

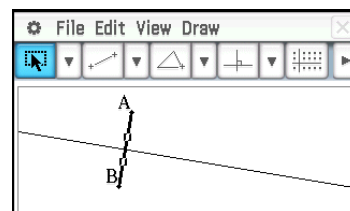

• **To construct a perpendicular line that passes through a specified point on a line**

1. Draw an infinite line, and then draw a point on the line through which you want the perpendicular line to pass.
2. Select the line and the point.
3. Tap [Draw], [Construct], and then [Perpendicular]. This draws a line through the point you selected, which is perpendicular to the line where the point is located.

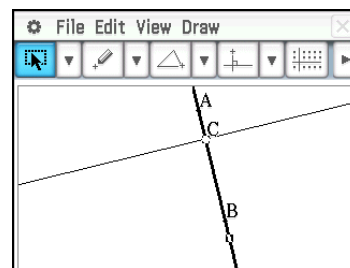

• **To construct a midpoint**

1. Draw a line segment and then select it.
2. Tap [Draw], [Construct], and then [Midpoint]. This adds a midpoint to the segment.

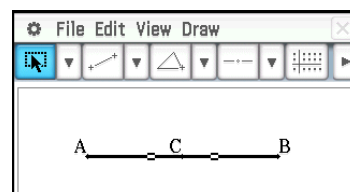

• **To construct the point of intersection of two lines**

1. Draw two lines that intersect, and then select both lines.
2. Tap [Draw], [Construct], and then [Intersection].
  - This adds the point of intersection. The point(s) of intersection of two circles or of a line and a circle can be constructed in the same manner.

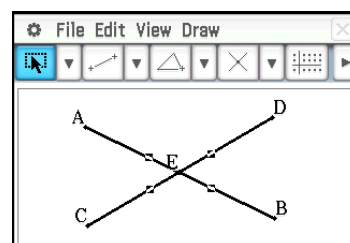

• **To construct an angle bisector**

1. Draw two line segments so they form an angle, and then select both line segments.
2. Tap [Draw], [Construct], and then [Angle Bisector]. This bisects the angle.

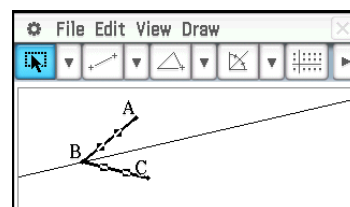

• **To construct a line parallel to another line through a specified point**

1. Draw a line and a point that is not on the line.
2. Select the line and the point.
3. Tap [Draw], [Construct], and then [Parallel]. This draws an infinite line that passes through the selected point and is parallel to the selected line.

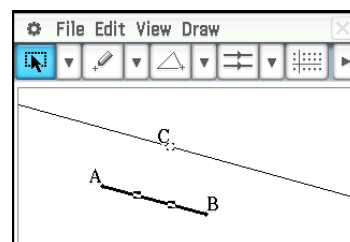

• **To construct a tangent to a curve through a specified point**

1. Draw a curve, such as an ellipse.
2. Tap [Draw], [Construct], and then [Tangent to Curve].
  - This highlights  on the toolbar.
3. Tap the point of tangency on the curve. This draws the tangent.

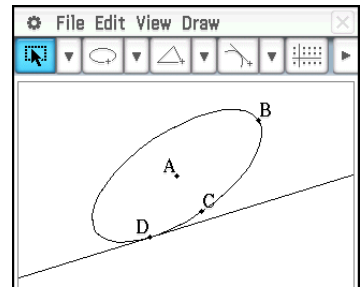

• **To reflect a line segment with respect to a specified line of symmetry**

1. Draw a line segment and a line to use as the line of symmetry, and then select the line segment.
2. Tap [Draw], [Construct], and then [Reflection].
  - This highlights  on the toolbar.
3. Tap the line of symmetry. This reflects the line segment you drew in step 1 about the line of symmetry.

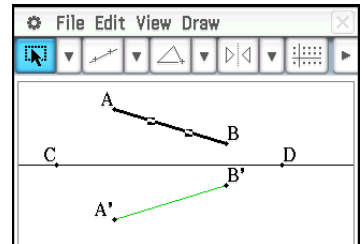

• **To translate a line segment by inputting a vector**

1. Draw a line segment (AB), and then select it.
2. Tap [Draw], [Construct], and then [Translation] to display the Translation dialog box.
3. Enter the vector for the translation.
  - Vector values indicate the amount of movement in the  $x$ -axis direction and in the  $y$ -axis direction. In the nearby screen, for example, the figure selected in step 1 moves parallel to the  $x$ -axis by three.
4. Tap [OK]. This translates line segment AB in accordance with the vector value you input, and draws line segment A'B'.

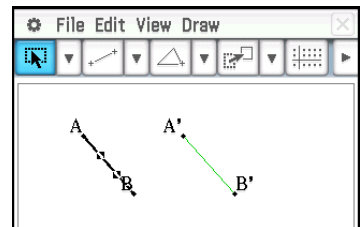
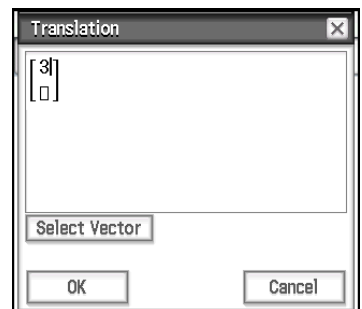

• **To translate a line segment by selecting a vector**

1. Draw a line segment (AB), and a vector to use in the translation. Next, select the line segment.
2. Tap [Draw], [Construct], and then [Translation] to display the Translation dialog box.
3. Tap [Select Vector].
4. Tap the vector on the screen. This translates line segment AB in accordance with the vector you selected, and draws line segment A'B'.

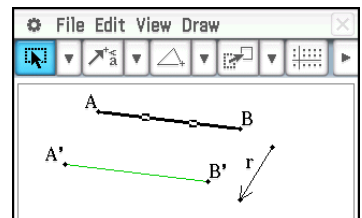

• **To rotate a line segment**

1. Draw a line segment, and then select it.
2. Tap [Draw], [Construct], and then [Rotation].
  - This highlights  on the toolbar.
3. Tap the screen once to select the center of rotation.
  - This displays the Rotation dialog box.
4. Specify the angle of rotation in degrees, and then tap [OK].

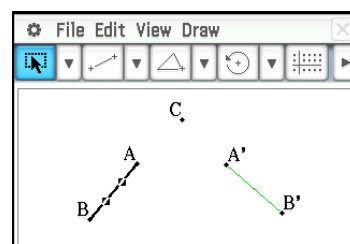

• **To dilate a line segment toward a specified center point**

1. Draw a line segment, and then select it.
2. Tap [Draw], [Construct], and then [Dilation].
  - This highlights  on the toolbar.
3. Tap the center of dilation.
  - This displays the Dilation dialog box.
4. Specify the dilation scale factor, and then tap [OK].

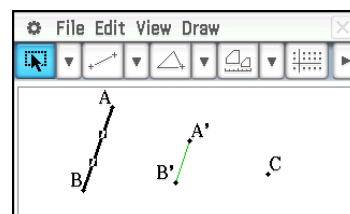

• **To transform a triangle using a matrix or vector (general transform)**

1. Tap  to turn on coordinate display in the Geometry window.
2. Draw triangle ABC, and then select its three sides.
3. Tap [Draw], [Construct], and then [General Transform]. This displays the Transform dialog box.
4. Enter the matrix for the transform.
  - In this example, let's input  $\begin{bmatrix} 1 & 0 \\ 0 & -1 \end{bmatrix}$ .
5. Tap [OK]. This draws triangle A'B'C', which is symmetrical to triangle ABC about the  $x$ -axis.
6. Tap anywhere outside of the triangles to deselect the currently selected triangle. Next, select triangle A'B'C'.
7. Tap [Draw], [Construct], and then [General Transform].
8. Enter the vector to perform parallel displacement.
  - In this example, let's input  $[1, 1]$ .

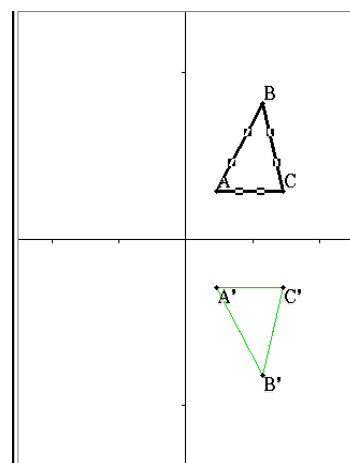
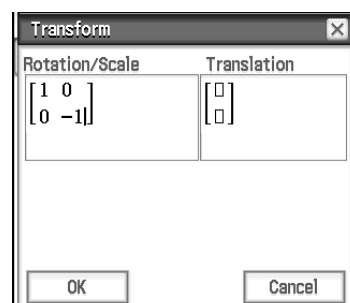

9. Tap [OK]. This performs the parallel displacement and draws triangle  $A''B''C''$ .

**Tip:** In the above example, we performed the transformation and the parallel displacement operations separately. You could also perform both operations at the same time, if you want. To do so, input both the matrix  $\begin{bmatrix} 1 & 0 \\ 0 & -1 \end{bmatrix}$  and the vector  $[1, 1]$  in step 4, and then tap [OK]. This will produce the result shown in step 9.

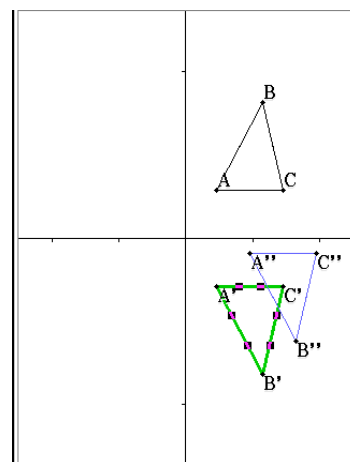

## 8-2 Editing Figures

This section explains how to move, copy, change the color of, and perform other editing operations on Geometry application figures.

### Selecting and Deselecting Figures

Before you can execute certain editing commands, you must first select the figure you want to edit. There are two figure selection modes: Select and Toggle Select, each of which is described below.

#### • Using Select

Tap  on the toolbar. This causes the button to become highlighted, indicating that Select is enabled. Select allows you to select as many figures as you would like, and then move, copy, paste, or perform other operations on the selection as a single entity.

- Tap  on the toolbar.
- To select side BC of the triangle, tap it.
- Tapping point D selects it, leaving side BC of the triangle selected, too.

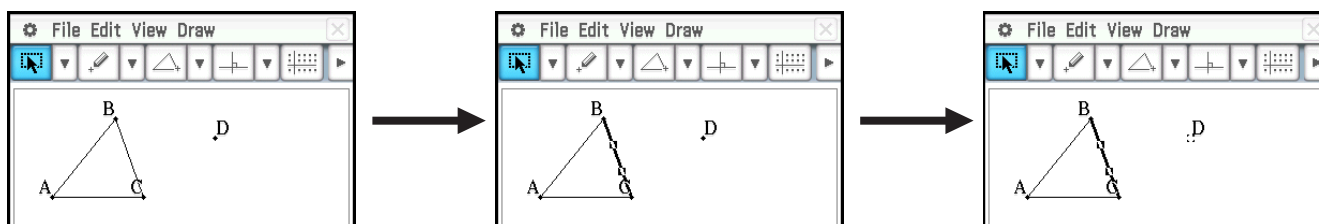

- To deselect all of the figures, tap anywhere on the screen where there are no figures.

#### • Using Toggle Select

Tap  on the toolbar. This causes the button to become highlighted, indicating that Toggle Select is enabled. Toggle Select allows you to select and deselect figures.

For example, if you have multiple figures selected, Toggle Select will allow you to deselect a single part of the selection. Tapping the part again will turn the selection back on.

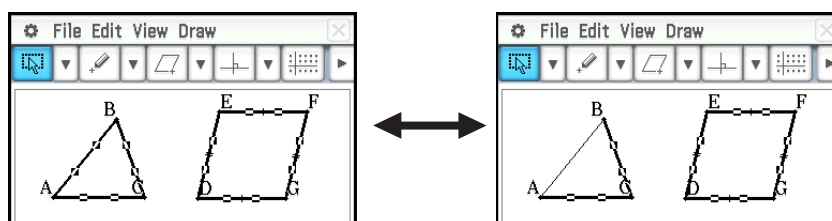

---

## Moving and Copying Figures

### • To move a figure

1. Draw a figure, and then select it.
2. Drag the figure to move it to the location you want.
  - A selection boundary appears around the figure when you drag it.
3. Remove the stylus from the screen.

### • To copy a figure

1. Draw a figure, and then select it.
2. Tap [Edit] - [Copy], and then [Edit] - [Paste].
3. Drag the pasted figure to the location you want.

---

## Pinning an Annotation on the Geometry Window

You can pin an annotation on the Geometry window using the Pin function. By default, annotations are ‘Unpinned’, so they pan or zoom along with the Geometry window. Pinning an annotation fixes its position on the screen so it is always displayed in the same location on the Geometry window.

### • To pin or unpin an annotation on the Geometry window

1. Select (highlight) the text on the Geometry window.
2. Tap [Edit], [Properties], and then [Pin] or [Unpin].
  - When text is pinned, it maintains its position as shown here even when the window is panned.

---

## Specifying the Number Format of a Measurement

You can specify the number format for each measurement value or all the measurement values on the Geometry window. The initial default number format setting for measurement values is “Fix 2”.

### • To specify the number format for selected measurement value(s)

1. Select (highlight) the measurement(s) you want to specify the number format.
2. Tap the [Edit], [Properties], and then [Number Format].
3. On the dialog box that appears, select the number format you want by tapping it.
  - For the meaning of each number format name, see “To specify the numeric value display format” on page 36.
4. Tap [OK].
  - This will display the measurement value(s) you selected in the step 1 using the specified number format.

### • To specify the number format for all the measurement values on the Geometry window

1. Tap anywhere on the screen where there are no figures to deselect all of the figures.
2. Perform the procedure from step 2 under “To specify the number format for selected measurement value(s)”.
  - This will display all the measurement values on the Geometry window using the specified number format.



---

## Specifying the Color and Line Type of a Displayed Object

You can use the procedure below to specify the color and line type for the outline of a figure, the fill color inside a figure, or the color of text, labels, and other non-figure objects.

### • To specify the color and line type of a particular object

1. Use the procedure under “Selecting and Deselecting Figures” (page 167) to select the object whose color and/or line type you want to specify.
2. Tap [Edit] and then [Style] to display the dialog box shown to the right.
  - The dialog box will show only supported settings, which depend on the composition of the selected object.



3. Configure the dialog box with the following settings.

To specify this:	Perform this operation:
Specify the text color	Tap “Character Color” and then tap the desired color.
Specify the line type	Tap “Graph Plot” and then tap the desired line type.
Specify the line color	Tap “Line Color” and then tap the desired color.
Specify the figure fill color	Tap “Area Color” and then tap the desired color. To specify no fill color, tap “Clear”.

4. To apply the settings you configure, return to the dialog box in step 2 of this procedure and then tap [OK].

### • To specify the color and line type of all the objects on the Geometry window

1. Tap anywhere on the screen where there are no figures to deselect all of the figures.
2. Perform the procedure from step 2 under “To specify the color and line type of a particular object”.



---

## Changing the Display Priority of Objects

Basically, objects you draw on the Geometry window are stacked in the order they are drawn (newest drawing on top). You can use the operations in this section to move a drawn object to the top or the bottom of the stack. You also can move all text to the front, if you want.

- To move a particular object to the front, select it and then tap [Edit] - [Properties] - [To the front].
- To move a particular object to the back, select it and then tap [Edit] - [Properties] - [To the back].
- To move all text to the front, tap [Edit], [Properties] and then [All Text].

## 8-3 Using the Measurement Box

Tapping the  button to the right of the toolbar displays the measurement box. Tap  to return to the normal toolbar.



Normal toolbar



Measurement box







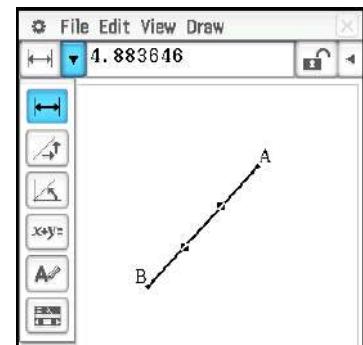





You can use the measurement box to view the measurements of a figure, to specify a measurement of a figure, to fix a measurement of a figure, or to name a figure.







### Viewing the Measurements of a Figure

The type of information that can be displayed in the measurement box depends on the figure currently selected on the screen. The nearby screen shows an example when a line segment is selected. You can change the display information type by tapping one of the icons.



The following table describes the information that appears when you tap each icon, and explains when each icon is available for selection.

Icon	Icon Name	This icon appears when this is selected:	Tapping this icon displays:	Lockable
	Coordinates	A single point	Coordinates of the point	Yes
	Distance/length	Two points on one figure or two different figures, or a single line segment or a vector	Distance between two points, length of a line segment or vector	Yes
	Slope	Single line, line segment, or vector	Slope of the line, line segment or vector	Yes
	Direction	Single line, line segment, or vector	Direction angle of the line (angle of inclination)	Yes
	Equation	Any single line or line segment, vector, circle, arc, ellipse or any other figure (parabola, etc.) drawn by a function	Function of the figure (using rectangular coordinates)	Yes
	Equation edit	Single parabola or any other figure drawn by a function	Equation of the figure in the function editing dialog box.	No
	Radius	Single circle or arc	Radius of circle or arc	Yes
	Circumference	Single circle	Length of the circumference	Yes
	Perimeter	Single polygon	Sum of the lengths of the sides	No
	Area	Any three points, an arc, ellipse, or polygon	Area	No
		Single circle	Area	Yes
 	Angle	Two line segments	Angle and its supplement formed by the line segments	Yes

Icon	Icon Name	This icon appears when this is selected:	Tapping this icon displays:	Lockable
	Tangency	Two circles or arcs, or a line and circle	Whether two items are tangent	Yes
	Congruence	Two line segments	Whether line segments are the same length	Yes
	Incidence	Point and a line, arc, circle or vector	Whether a point is on the line/curve	Yes
	Point on curve	Point and a function, curve, or ellipse		
	Rotation angle	Two points created by [Rotation]	Angle of rotation	*1
	Scale of dilation	Two points (like point A and point A') on a figure created by [Dilation]	Scale of dilation	*1
	Text icon	An object that includes text or an object that can be named	Editable text used to name the selected image	No

\*1 The value in the measurement box is always locked while this tool is selected.

### • To view the measurements of a line segment

1. Draw a line segment.
2. Tap  on the toolbar to display the measurement box.
3. Select the line segment.
  - This displays the length of the line segment.

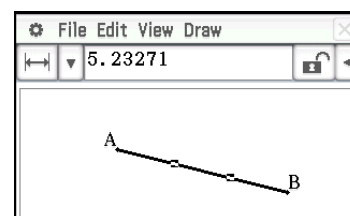

4. Tap the down arrow next to the measurement box to cycle through other measurements.
  - In the case of the line segment, for example, you can view its length, slope, direction, and equation.

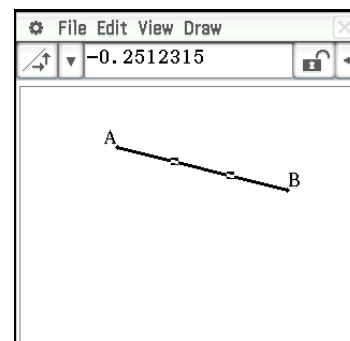
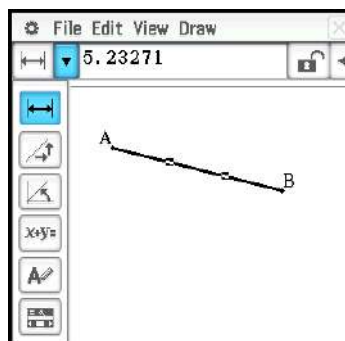

## Specifying and Constraining a Measurement of a Figure

The following example shows how to specify and constrain (fix) an angle of a triangle. By “constraining a measurement” we mean that it becomes fixed. For example, constraining (fixing) angle B of triangle ABC at 90 degrees will cause angle B to remain at 90 degrees regardless of where the apex is moved.

### • To specify and constrain the measure of an angle of a triangle\*

1. Draw the triangle, and then select its side AB and side BC.
2. Tap  on the toolbar to display the measurement box.
  - This displays the measure of angle B in the measurement box.

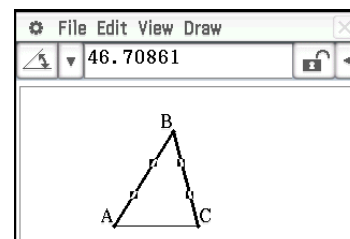

3. Input 90 into the measurement box and press [EXE].

- This specifies and constrains the measure of angle B at 90 degrees.

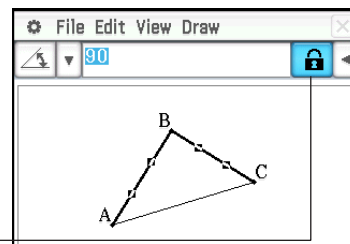

A highlighted check box indicates the measurement is constrained (fixed).

\* In this example, the [Measure Angle] setting of the Geometry Format dialog box (page 40) is set to “Degree”.

**Tip:** To cancel the constraint of a measurement value fixed using the above operation, tap the check box to the right of the measurement box to unhighlight it. Each tap of the check box toggles the measurement value between fixed and unfixed.

### • To clear all settings constrained with the measurement box

Tap [Edit] and then [Clear Constraints].

## Using Sliders



Sliders can be displayed and used to change the settings of the objects in the table below. Select the desired object and then display its slider using the procedure following the table.

For this type of selected object(s):	This type of slider can be displayed:
Any two sides of a polygon or two line segments	Angle, supplementary angle
Two points on one figure or two different figures, or a single line segment or a vector	Length
Single circle or arc	Radius

### • To display a slider

1. Select the required object(s), as described in the table above.
2. Tap [Draw] - [Slider]. On the sub-menu that appears, select the type of measurement ([Angle], [Supplementary Angle], [Length], [Radius]) you want to perform with the slider.
  - The items that appear on the sub-menu depend on the object you select in step 1 of this procedure.

**Note:** Instead of step 2 in the above procedure, you could also perform the steps below to display a slider.

- (1) Tap  on the toolbar to display the measurement box.
- (2) Tap the down arrow to the right of icon palette on measurement box and then .

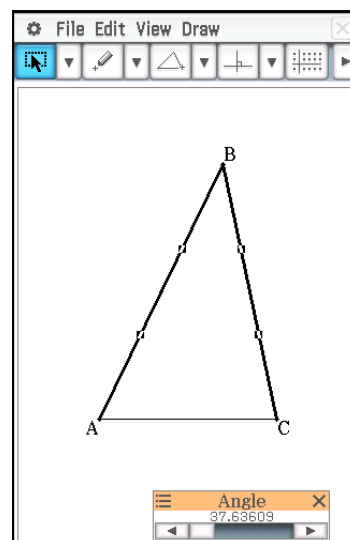

• **To specify the measurement minimum value, maximum value, and step value for a slider**

1. Perform the operation under “To display a slider” to display a slider.
2. Tap the upper left corner of the slider display box.
3. On the menu that appears, tap [Settings].
4. On the Slider Settings dialog box that appears, display the tab for the measurement you want to change.
  - The dialog box has four tabs: [Angle], [SuppAngl] (supplementary angle), [Length], and [Radius]. You can select any of the tabs and change its settings, regardless of the measurement controlled by the slider you selected in step 1 of this procedure.

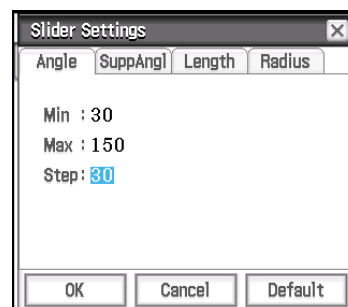

5. Input values for **Min** (minimum value), **Max** (maximum value), and **Step** (step value).
  - For the Angle and SuppAngl tabs, you should input a value in the angle unit (degrees, radians, or grads) currently specified by the “Measure Angle” setting on the Geometry Format dialog box. The input range depends on the current angle unit setting: 0 to 180 for degrees, 0 to  $\pi$  for radians, and 0 to 200 for grads. Attempting to input a value that is outside the current allowable range will automatically change the input value so it is within range.
  - On the Length and Radius tab, input a value that is greater than zero.
  - To return the setting values on the currently displayed tab to their initial values, tap the [Default] button. Refer to the “Initial Defaults” table for information about default settings.
6. After configuring the settings you want, tap [OK] to save them.
  - This closes the Slider Settings dialog box.

**Initial Defaults**

Measurement		Min	Max	Step
Angle, Supplementary Angle	Degree	30	150	30
	Radian	$\pi/6$	$5\pi/6$	$\pi/6$
	Grad	100/3	500/3	100/3
Length		1	10	1
Radius		1	5	1

• **To use a slider to seamlessly change an angle and/or length**

**0804** Angle B of triangle ABC is fixed at  $90^\circ$ , and the length of side AC is also fixed. Confirm the movement of vertex B along the circumference of a circle that has side AC as its diameter as angle A changes. Here, angle A changes at  $10^\circ$  increments within a range of  $10^\circ$  to  $80^\circ$ .

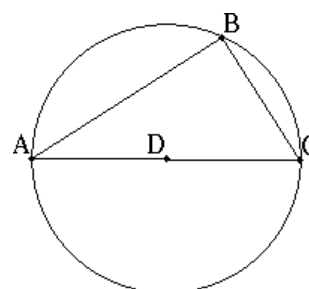

---

## Changing a Label or Adding a Name to an Element

You can change the name of a point, or add a name to each element as explained in the following example.

### • To change the label name of the center of a circle from “B” to “Center”

1. Draw the circle, and then select its center point.
2. Tap the down arrow to the right of icon palette on measurement box and then .
  - This displays the current name of the point in the measurement box. The displayed name is highlighted so it can be edited.
3. Input a new name (“Center”) in the measurement box.
4. Press **[EXE]** or the check box to the right side of measurement box.
  - This displays the changed name on the screen as shown here.

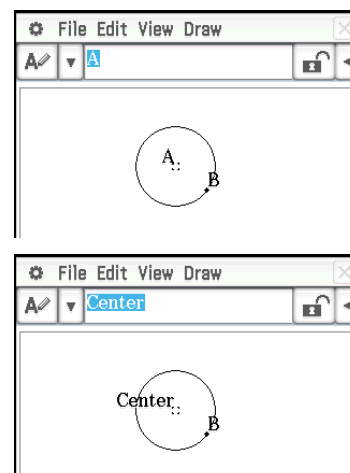

## 8-4 Working with Animations

An animation consists of one or more point/curve pairs, in which the curve can be a line segment, circle, ellipse, or function. You build an animation by selecting a point/curve pair, and then adding it to an animation.

---

### Using Animation Commands

You can build and run an animation either by executing menu commands or by using the animation toolbar that appears when you tap [View] and then [Animation UI].

#### [Edit] – [Animate]

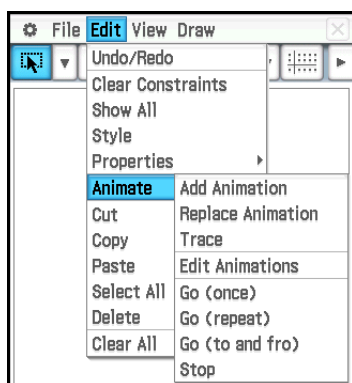

#### [View] – [Animation UI]

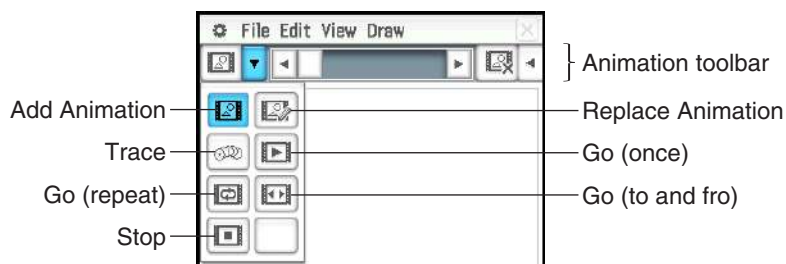

- Most of the procedures in this section are performed using the [Animate] submenu.
- All of the [Animate] menu commands can be accessed from the animation toolbar, except for [Edit] - [Animate] - [Edit Animations].
- To close the animation toolbar and return to the normal toolbar, tap the  button on the right side of the animation toolbar, or tap [View] and then [Animation UI].

• **To add an animation and run it**

1. Plot a point and draw a figure (here we draw a parallelogram). Or, you could draw a circle, arc, ellipse, line segment, or function instead of a figure.
2. Select the point and a side of the parallelogram.

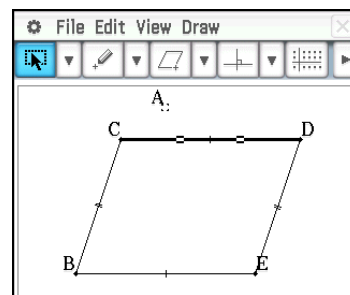

3. Tap [Edit], [Animate], and then [Add Animation].
  - The point selected in step 2 moves along the side of the parallelogram.
4. Tap [Edit], [Animate], and then [Go (once)], [Go (repeat)], or [Go (to and fro)].

Point A moves along side CD.

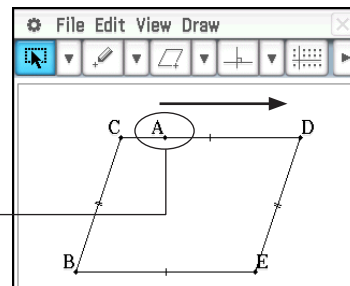

5. Tap [Edit], [Animate], and then [Stop] to stop the animation.
  - You can also stop the animation by tapping <sup>Esc</sup> on the icon panel.

• **To replace the current animation with a new one**

1. Select the point and curve for the new animation.
2. Tap [Edit], [Animate], and then [Replace Animation].
  - This discards the currently set animation and sets up an animation for a new point and curve set. Tap [Edit], [Animate], and then [Go (once)] to see your new animation.

• **To trace a locus of points**

**Note:** Using trace leaves a trail of points when the animation is run. The procedure below is a continuation of the procedure under “To add an animation and run it”.

1. Draw a line segment that connects point A with apex B.
2. Draw the center point of line segment AB.
  - Select line segment and then tap [Draw] - [Construct] - [Midpoint].
3. Select the center point of line segment AB (point F) and then tap [Edit] - [Animate] - [Trace].
4. Tap [Edit], [Animate], and then [Go (once)].
  - This draws a line using point F as the locus, that is parallel to and whose length is half that of side CD of the parallelogram.

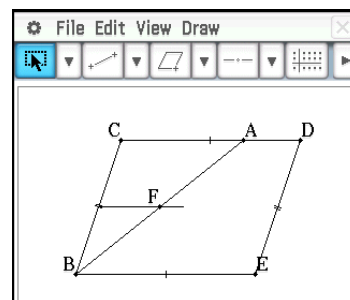
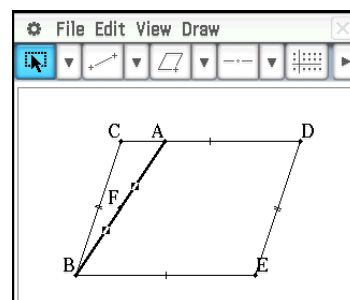
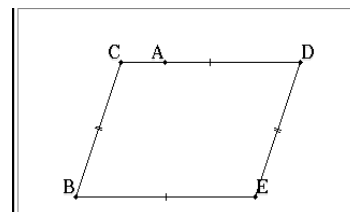

**0805** To create an animation that traces the locus of specific points

## • To edit an animation

**Note:** The steps below continue from the procedure under “To trace a locus of points”.

1. While the animation you want to edit is on the display, tap [Edit], [Animate], and then [Edit Animations].
  - This displays the animation editing window in the lower window. The upper window contains the animation that we just completed in “To trace a locus of points”.
2. Edit the animation following the procedure below.

### Steps:

This setting specifies how many steps point A takes to move along side CD. The initial default value is 20, which can be changed to value from 2 to 100.

### Animations:

The “A” under “Animations” indicates that point A is the point moved by the animation. When you are building multiple animations, a list of all applicable points appears here.

Tapping [Remove] deletes the applicable animation.

“t0” and “t1” specify the range of movement of point A on side CD. The initial default values are  $t_0 = 0$  and  $t_1 = 1$ . During animation, the length of CD is considered to be one unit. The default values specify that movement of point A is from start point C (point where length equals 0) up to end point D (point where length equals 1).

Changing the value of  $t_0$  to 0.5, for example, causes point A to move from the middle of side CD to point D. Changing the value of  $t_0$  to  $-1$ , causes point A to begin at a point outside side CD (in this case, at a point a distance equivalent to the length of side CD) and ending with point D.

### Traces:

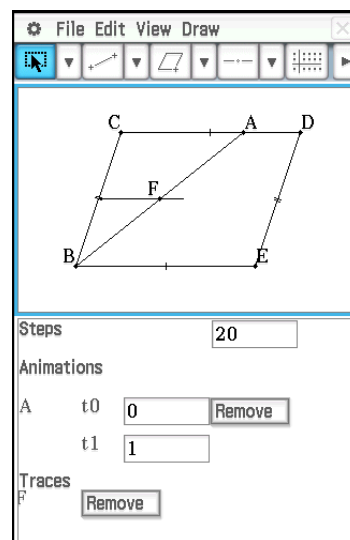

This item shows the specified trace point. Tapping [Remove] cancels the trace point setting.

3. While the lower window is active, tap  to close the animation editing window.



## • To view an animation table

**Note:** The steps below continue from the procedure under “To trace a locus of points”.

1. Tap line segment AB, which connects point A with apex B, to select it.
2. Tap  on the toolbar to display the measurement box.
  - This displays the measurement of line segment AB in the measurement box.
3. Tap  next to the measurement box.
  - This displays a table showing the length of line segment AB for each animation step in the bottom half of the screen.

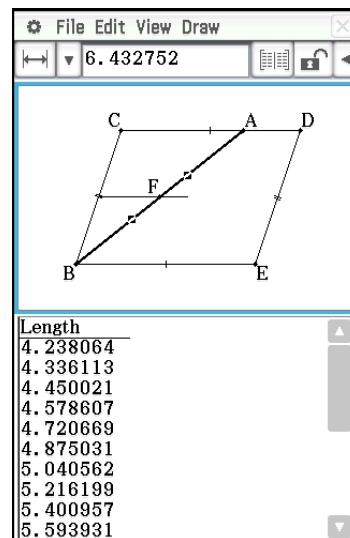



4. Next, let's add a column to the table that shows the area of triangle ABE at each step. Perform the steps below.

(1) Draw a line segment that connects point A with apex E.

(2) Select line segment AB, line segment AE, and side BE.

(3) Tap  next to the measurement box.

This adds a column that shows the area of triangle ABE at each step. (As can be seen, the area of triangle ABE does not change even when point A moves.)

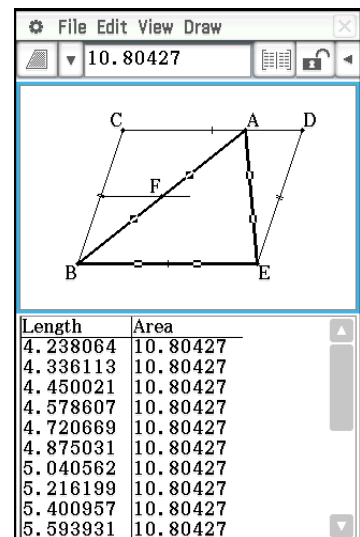

## 8-5 Using the Geometry Application with Other Applications

You can display the Geometry application from within the eActivity or Main application. This feature allows you to visualize the relationship between Algebra and Geometry. You can, for example, drag a figure from the Geometry window to the eActivity window to see its corresponding mathematical expression.

### Drag and Drop

When you open Geometry within another application, you can drag and drop information between the two application windows. You can see an actual example ([0243](#)) of how this is done using the Main application in Chapter 2 of this manual.

The information that appears when you drop a figure into another application depends on the figure you are dragging. Many of the possible outcomes are listed in the table below.

Geometric Figure	Drag and drop into another application transforms to:	*1
Point	Ordered pair	Yes
Line Segment, Infinite Line, Ray	Linear equation	Yes
Vector	Ordered pair (head of vector, assuming the tail is at the origin)	No
Circle, Arc	Equation of a circle	Yes
Ellipse	Equation of an ellipse	Yes
Function ( $y = f(x)$ )	Equation of the function	Yes
Two Lines	System of equations	No
Polygon, or open polygon created by animation	Matrix containing each vertex point	No
Pairs of points related by a transformation	Expression showing point relationship	No

\*1 Support for drag and drop into a Geometry Link row in an eActivity. For details about a Geometry Link row, see "Inserting a Geometry Link Row" on page 184.

### Copy and Paste

In addition to drag and drop, you can also copy figures or columns from an animation table and paste them into another application.

# Chapter 9: Numeric Solver Application

Numeric Solver application lets you obtain the value of any variable in an equation without transforming or simplifying the equation.

Starting up the Numeric Solver displays the Numeric Solver window. The screen to the right shows an example of the window with a sample equation input.

- ① Equation input area. Inputting an equation that includes variables and then pressing **[EXE]** will cause ② and ③ to appear.
- ② Equation variables. Input the initial value of each variable to the right of the equals sign (=). Specify the variable you want to solve for by selecting the option button to the left of it.
- ③ Solution lower limit and upper limit input area\*
- ④ Current convergence range setting\*

\* Values shown in the sample screen are initial defaults.

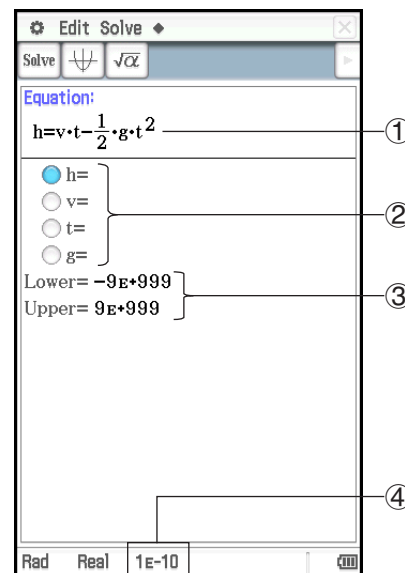

## Numeric Solver Application-Specific Menus and Buttons

- Solve the input equation for the specified variable ..... Solve - Execute or **[Solve]**
- Clear all single-character variables (a through z)\* ..... **[Clear a-z]**
- Initialize the upper boundary and lower boundary ..... **[Initialize Bound]**
- Change the convergence range..... **[Convergence]**

\* Performing the “Clear a–z” operation clears all single-character variables, regardless of variable data type. Programs and functions with file names from “a” through “z” are also cleared.

## Inputting an Equation

On the Numeric Solver window, input a single equation into the area under “Equation”.

- Use the soft keyboard to input an equation that contains at least one variable.
- If you do not input an equals sign, the ClassPad assumes that the expression is to the left of the equals sign, and there is a zero to the right.

## Solving an Equation

Numeric Solver solves equations by calculating approximations based on Newton’s method. Because of this, you should keep the following points in mind about its solutions.

- Even if an equation has multiple solutions, only one solution is obtained for a particular Numeric Solver operation. For example,  $x^2-1 = 0$  has the two solutions 1 and  $-1$ . Numeric Solver will display either of the solutions first, depending on the value specified by “Lower” and “Upper”.
- Solutions may include errors that are not actual solutions. The accuracy of solutions can be determined by viewing the [Left–Right] value in the Result dialog box. The closer the [Left–Right] value is to zero, the more accurate the results.

## • To solve an equation

- On the Numeric Solver window, input an equation.
  - Here, we will input the equation  $y = x^2 - 2$ , and solve for  $x$  when  $y = 0$  and  $y = 2$ .
- Press **[EXE]**.
- Input 2 as the values for variable  $y$  (to the right of  $y=$ ).
- Since we want to solve for  $x$ , select the option button to the left of variable  $x$  (so the button next to the variable becomes ).
- Tap **[Solve]**.
  - This displays the Result dialog box with the calculation result. Tap [OK] to close the dialog box.
- Input 0 as the values for variable  $y$  (to the right of  $y=$ ).
- Tap **[Solve]**.
  - Though the solution of  $x^2 - 2 = 0$  is  $x = \pm\sqrt{2}$ , here the value that is displayed is the decimal form of  $\sqrt{2}$ , which is near the last solution obtained ( $x = 2$ ).

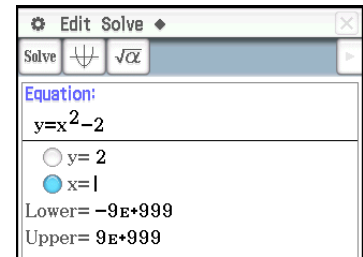

To obtain the other solution, change the Upper value (to 0, for example) and then tap **[Solve]**.

**0901**  $t$  is the time it would take for an object thrown straight up with initial velocity  $v$  to reach height  $h$ . Use the formula  $h = vt - 1/2 gt^2$  to calculate the initial velocity  $v$  for a height of  $h = 14$  meters and a time of  $t = 2$  seconds. Gravitational acceleration is  $g = 9.8 \text{ m/s}^2$ .

### Tip

- If ClassPad judges that the displayed results are not converging sufficiently, it displays the message “Did not converge. Do you wish to continue the calculation?” Tap [Yes] to continue, or [No] to cancel the calculation.
- If the message “Can’t solve!” appears on the display, perform either (or both) of the operations below and then tap **[Solve]** again.
  - Tap **[Initialize Bound]**, or manually change the “Lower” and “Upper” values.
  - Change the convergence range. See “To change the convergence range” below.

## • To change the convergence range

- Tap **[Convergence]** to display the Convergence dialog box.
- Enter an integer in the range of 1 to 13.
  - A smaller value increases the allowable error range, and lessens the chance of a “Can’t solve!” error. If a calculation causes a “Can’t solve!” error, try changing this setting to a smaller value.
- Tap [OK] to apply the setting and close the dialog box.
  - The new setting value will be shown in the status bar (page 178).

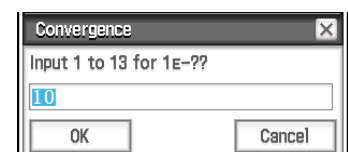

# Chapter 10: eActivity Application

The eActivity application lets you input and edit text, mathematical expressions, and ClassPad application data, and save your input in a file called an “eActivity”.

A basic eActivity can contain text along with application data, which is embedded as a row or a strip. A row can be a “Text Row”, a “Calculation Row”, or a “Geometry Link”. A strip can be an “application data strip” (Main, Graph & Table, Geometry, and so on).

## Example eActivity windows

- ① eActivity window
- ② Graph strip
- ③ Expand button
- ④ Expanded graph window

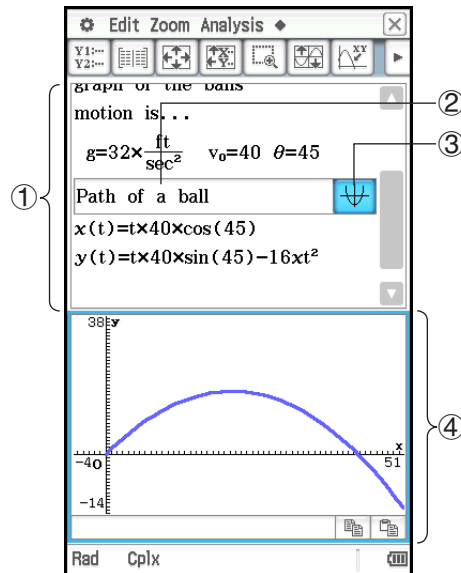

**Tip:** A variety of eActivity files are available for download at the CASIO Website.

<https://edu.casio.com/products/classpad/>

After you download an eActivity file, you will need to transfer it from your computer to your ClassPad. See the instructions provided at the CASIO Website for more information.

## eActivity Application-Specific Menus and Buttons

- Clear variables that contain numbers, list and matrices ..... Edit - Clear All Variables
- Insert a row or strip ..... Insert - Calculation Row (page 182); Text Row (page 181);  
Geometry Link (page 184); Strip(1) or Strip(2) (page 182)
- Add help text to the currently selected strip ..... Insert - Add Strip Help
- Insert a command ..... Action (page 61)
- Open or save a file .....
- Bold the text that is currently selected (Text Input mode only) .....
- Convert a text row to a calculation row or a calculation row to a text row ..... /

## 10-1 Creating an eActivity

### Basic Steps for Creating an eActivity

1. Start the eActivity application.
  - This displays the eActivity window as it appeared the last time it was used.
  - If you are already in the eActivity application and there is data on the display, tap [File] and then [New]. Note that [New] clears data from the display without saving it.

2. On the eActivity window, insert the text, expressions, application data, and other data you want to include in the eActivity. For details, see “Inserting Data into an eActivity” below.
3. After the eActivity is the way you want, tap [File] and then [Save].
4. On the dialog box that appears, enter a file name and then tap [Save] to save the eActivity.

**Tip:** eActivity files are stored in a memory area that is separate from that used for storing other types of data (variable data, Geometry data, Spreadsheet data, etc.). Because of this, you cannot access eActivity files data using the Variable Manager. You have to use the eActivity application to perform eActivity file operations.

## Inserting Data into an eActivity

The following describes the four types of data you can insert into an eActivity.

### Text row

A text row can be used to insert text data and mathematical expression text in natural format. You can also bold the text in a text row.

### Calculation row

Use the calculation row to insert any of the calculation operations that are available in the Main application.

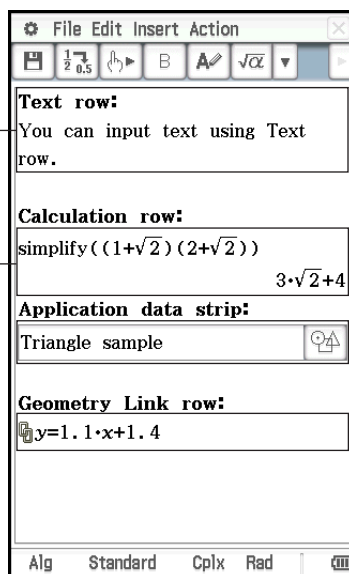

### Application data strip

The application data strip lets you display a window from a ClassPad application (Main, Graph & Table, Geometry, etc.) and use the window to create data, which is inserted into the eActivity.

### Geometry Link row

Use this row to insert data that is linked with a Geometry window figure.





## • To insert a text row

1. On the eActivity window toolbar, check to make sure that is displayed. If it isn't, tap to toggle it to .
  - indicates the Text Input mode is selected.
  - If the cursor is located in a line that already contains input data, place the cursor at the end of the line, tap [Insert] and then [Text Row]. This inserts a text row on the next line.
2. Use the soft keyboard or keypad keys to input the text you want.
  - Pressing [EXE] will advance you to the next line without displaying results.
  - Standard text (words separated by spaces) is automatically wrapped to the next line as required. A continuous text or number string (one that does not include any spaces) will not be wrapped to the next line if it does not fit within the width of the window.
  - Note that any mathematical expressions or commands you input into a text row are treated as text. They are not executed.

### Tip

- Text can be changed to bold by dragging to select it and then tapping . However, note that you cannot bold numeric expressions or a natural display expression that you input with the template input mode (page 24).
- You can select a range of characters with the left and right cursor keys. Simply press the ClassPad key and then press or . Each press of the cursor key will select (highlight) the next character in the applicable direction.

### • To insert a calculation row

1. On the eActivity window toolbar, check to make sure that  is displayed. If it isn't, tap  to toggle it to .
  -  indicates the Calculation Input mode is selected.
  - If the cursor is located in a line that already contains input data, place the cursor at the end of the line, tap [Insert] and then [Calculation Row]. This inserts a calculation row on the next line.
2. Use the soft keyboard or keypad keys to input the mathematical expression you want.
3. Press **[EXE]** after inputting an expression to display its result.

#### Tip

- If the input expression of a calculation row is not a valid expression, the row will contain only the input expression, without an output expression.
- If you edit the expression in an existing calculation row and then press **[EXE]**, all of the expressions following the line you edited are re-calculated and their results are refreshed.

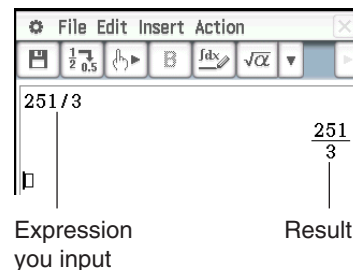

### Inserting an Application Data Strip

An application data strip can be used to embed data from other ClassPad applications into an eActivity. An application data strip contains the elements shown to the right.

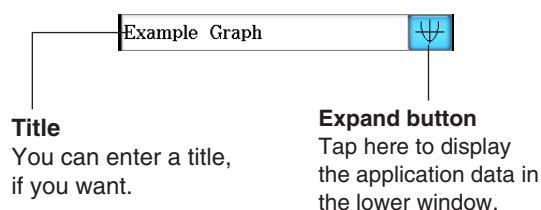





















### • To insert an application data strip

1. On the eActivity window, tap [Insert] and then [Strip(1)] or [Strip(2)]. Next, tap a menu item based on the type of application data you want to insert. See “Application data strip list” below for details about application data types.
  - This inserts the data strip into the eActivity window, opens a data strip window in the lower half of the display, and makes the data strip window active.
2. Perform the required input procedure in accordance with the type of window that is opened. For details, see the examples, below.
3. After completing all the data strip window operations, tap  to close the window.
  - This makes the eActivity window active, with the cursor in the strip you inserted in step 1.
4. Enter the title you want.

**1001** To insert a Graph strip

**1002** To insert a Notes strip

## Application data strip list

To insert this type of application data:	Select this [Insert] menu item:	Or tap this button:
Graph window data (Graph & Table)	Strip(1) - Graph	
Graph Editor window data (Graph & Table)	Strip(1) - Graph Editor	
3D Graph window data	Strip(1) - 3D Graph	
3D Graph Editor window data	Strip(1) - 3D Graph Editor	
Geometry window data	Strip(1) - Geometry	
Spreadsheet window data	Strip(1) - Spreadsheet	
Stat Graph window data	Strip(1) - Stat Graph	
Stat Editor window data	Strip(1) - Stat Editor	
Notes window* <sup>1</sup>	Strip(1) - Notes	
Main work area window data	Strip(1) - Main	
Conics Graph window data	Strip(2) - Conics Graph	
Conics Editor window data	Strip(2) - Conics Editor	
Differential Equation Graph window data	Strip(2) - DiffEqGraph	
Differential Equation Graph Editor window data	Strip(2) - DiffEqGraph Editor	
Financial window data	Strip(2) - Financial	
Probability window* <sup>2</sup> data	Strip(2) - Probability	
Numeric Solver window data	Strip(2) - NumSolve	
Sequence Editor window data	Strip(2) - Sequence Editor	
Verify window* <sup>2</sup> data	Strip(2) - Verify	
Picture Plot window data	Strip(2) - Picture Plot	

\*1 The Notes window can be used with the eActivity application only.

\*2 The Probability window and Verify window can be used with the eActivity application and Main application. For more information see “2-10 Using Verify” and “2-11 Using Probability”.

### • To add help text to a strip

1. Tap the title box of the strip to which you want to add help text.
2. Tap [Insert] - [Add Strip Help].
  - A help window appears in the upper half of the display, while the window that was called from the strip appears in the lower half of the display.
3. Input the help text into the help window.
4. After inputting all the text you want, tap  to close the help window.
  - The strip will now have a **i** button. Tapping **i** will display the help window along with the application window.

**Tip:** To delete help text from a strip, tap the title box of the strip whose help text you want to delete, and then tap [Insert] - [Remove Strip Help].

## Inserting a Geometry Link Row

A mathematical expression in a Geometry Link row in an eActivity dynamically links to figure(s) in the Geometry window.

Dragging a line or figure from the Geometry window to a Geometry Link row in an eActivity converts the line or figure to its mathematical expression. Conversely, dragging an expression from a Geometry Link row to the Geometry window converts the expression to its graphical form (line, curve, circle, etc.). This expression is interlinked with its Geometry window figure, so modifying one causes a corresponding change in the other.

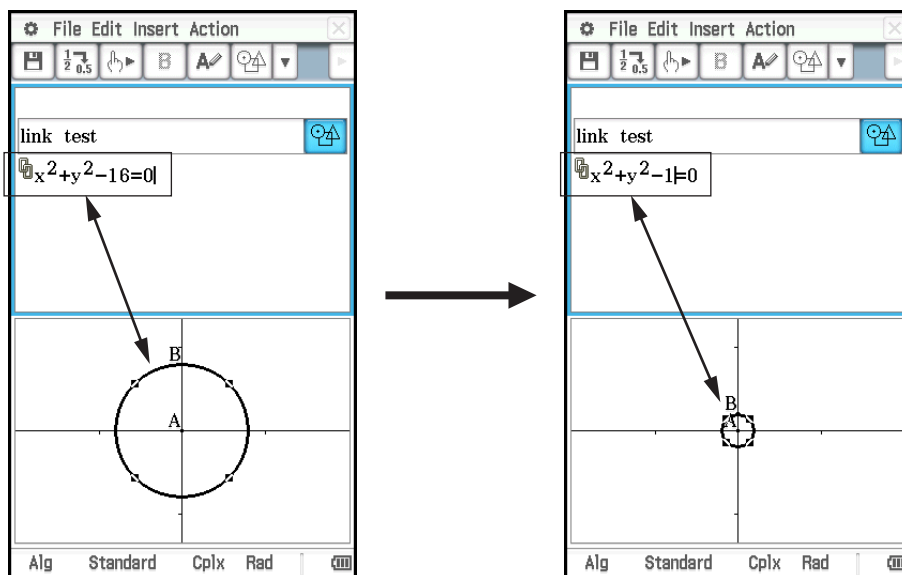

### • To use a Geometry Link row

**Example:** To drag one side of a triangle drawn on the Geometry window and link it to an eActivity

1. From the eActivity menu, tap [Insert], [Strip(1)], and then [Geometry] to insert a Geometry strip.
2. On the Geometry window that appears in the lower half of the screen, draw a triangle.
3. Tap the eActivity window to make it active.
4. Tap [Insert] and then [Geometry Link].
  - This inserts a Geometry Link row in the next line.

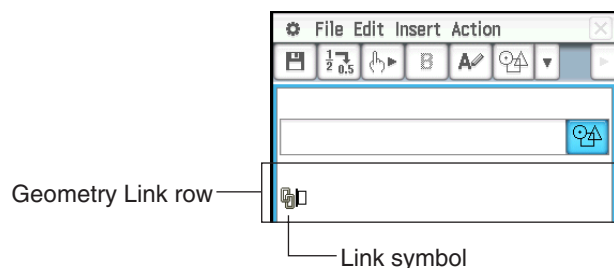

5. Tap the Geometry window to make it active.
6. Tap one side of the triangle to select it, and then drag it to the right of the link symbol in the eActivity window.
  - This inputs the equation of the line that represents the side of the triangle into the link.
  - Modifying the equation in the Geometry Link row and pressing **[EXE]** causes a corresponding change in the Geometry window.



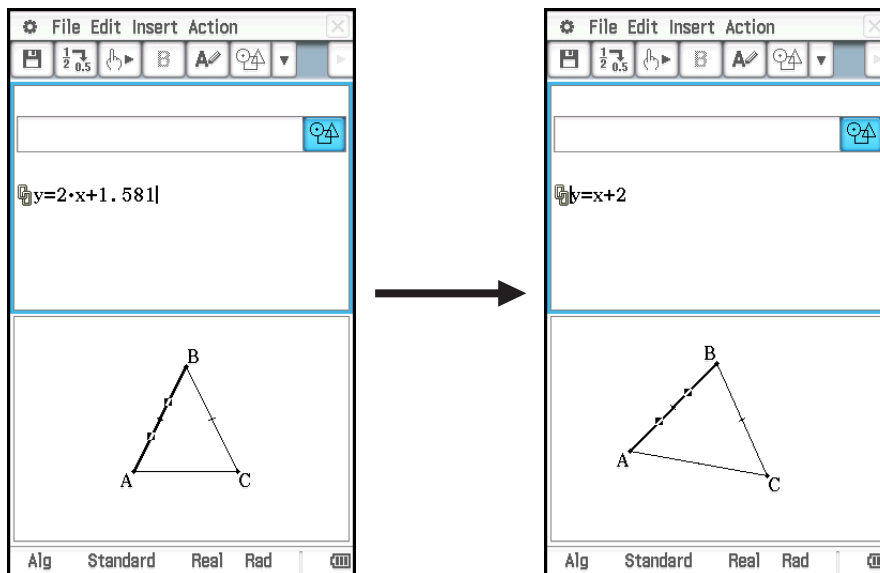

- The example above shows how the isosceles triangle ABC ( $CA = BC$ ) changes when the equation in the Geometry Link row is changed from  $y = 2x + 1.581$  to  $y = x + 2$ .

### Tip

- Pressing **[EXE]** after changing data in a Geometry Link updates the corresponding figure in the Geometry window.
- Changing the figure in the Geometry window will cause the linked data in an eActivity to update accordingly.

## 10-2 Transferring eActivity Files

### File Compatibility

Note the following precautions when using the ClassPad's data communication function to transfer eActivity files with another ClassPad unit or a computer.

- The ClassPad II supports only eActivity files created with a ClassPad II unit or with ClassPad Manager. eActivity files created with another ClassPad model cannot be opened by the ClassPad II.
- You may not be able to open an eActivity file created using a newer version ClassPad II using an older version ClassPad II.

### Transferring eActivity Files between a ClassPad Unit and a Computer

You can transfer eActivity files between ClassPad and a computer. For details, see "19-2 Performing Data Communication between the ClassPad and a Personal Computer".

### Transferring eActivity Files between Two ClassPad Units

You can connect two ClassPad II units to each other and transfer eActivity files between them. For details about how to do this, see "19-3 Performing Data Communication between Two ClassPads".

# Chapter 11: Financial Application

You can use the Financial application to perform a variety of financial calculations.

## **Important!**

Financial calculation rules and practices can differ according to country, geographic area, or financial institution. It is up to you to determine whether the calculation results produced by this calculator are compatible with the financial calculation rules that apply to you.

## 11-1 Financial Application Basic Operations

- Each time you select a calculation from the Financial application menu, a new page is added for that calculation.
- Each page has input boxes for inputting values and input/calculation boxes that can be used both to input values and display calculation results.

The examples below explain basic operations using the Financial application page.

**Example:** What is the final value after two years (730 days) of a \$3,000 investment earning 5.0% simple interest? Also calculate the final value during the same period for the same investment when the simple interest rate is 3%.

1. On the application menu, tap  to start the Financial application.
  - If this is the first time the application is being started up, the Financial menu window will appear.
2. Tap [Calc(1)] and then [Simple Interest] (or, on the Financial menu window, tap “Simple Interest”).
  - This will add a new page for performing the calculation (page 1) and display the “Simple Interest” page.

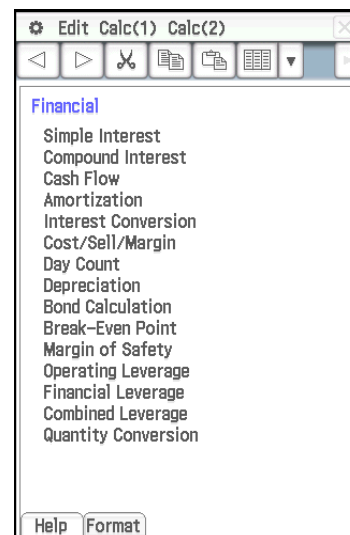

Financial menu window

3. Input the following information: Days = 730; I% (annual interest rate) = 5; PV (present value) = -3000.
4. Tap [SI] and then [SFV].
  - This will display the calculation results for simple interest (SI) and simple future value (SFV = principal + interest).

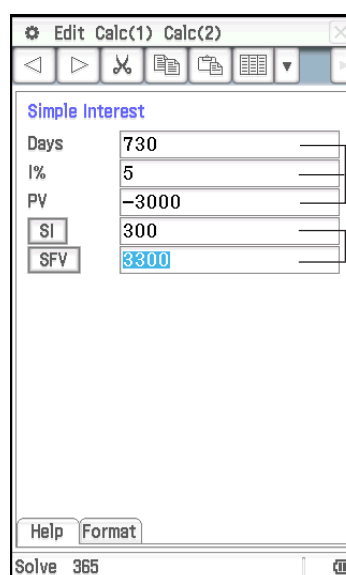

**Input box**  
Input values in the box.

**Input/calculation box**  
Input values when required. For calculation, tap the button to the left of the box.

5. Tap [Calc(1)] and then [Simple Interest] again.
  - This adds a new page (page 2). The new page will inherit value input on the previous page (under initial settings).
6. Change the *I%* value to 3, tap [SI], and then [SFV].
  - The SI and SFV values are updated in accordance with the new *I%* value.

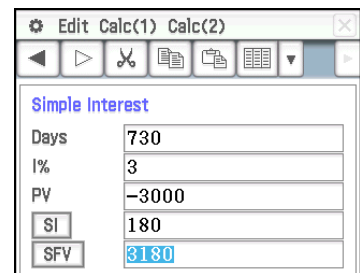

**Tip**

- If the cursor is in an input/calculation box, “Solve” will appear on the left side of the status bar. You can tap this to complete the calculation instead of tapping the box to the left of the input/calculation box.
- Financial application pages remain in memory even if you exit the Financial application. The next time you start up the Financial application, the page that was displayed the last time you exited the application will appear first.

---

## Page Operations

As shown in the sample operation above, each time you select a calculation from the Financial application menu, a new page is added for that calculation. The following types of operations can be performed on a page.

- Display the previous page or following page\*<sup>1</sup> .....Tap ◀ / ▶
- Display help about the currently selected field on the page..... Tap [Help] tab
- Change the settings of the displayed page’s calculation ..... Tap [Format] tab
- Delete the currently displayed Financial application page\*<sup>2</sup>  
.....Edit - Delete Page
- Clear all the values from the displayed Financial application page  
.....Edit - Clear Page
- Delete all the Financial application pages and display the Financial application initial screen\*<sup>3</sup> ..... Edit - Clear All

\*1 ◀ and/or ▶ on the toolbar indicates that there is a page before and/or after the current page. ◀ and/or ▶ indicates there is no page before and/or after the current page. In this case, tapping ◀ or ▶ will not change to another page.

\*2 Executing this operation when there is only one page will display the Financial menu window.

\*3 Executing this operation will display the Financial menu window.

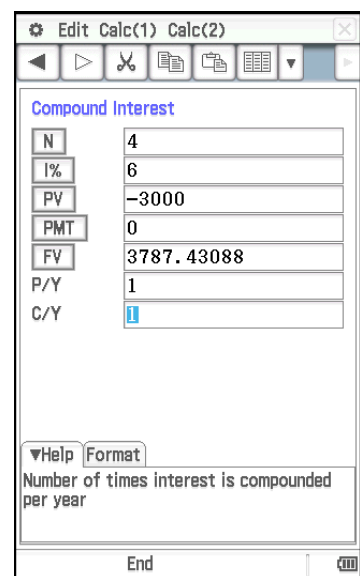

**Note:** If the currently displayed page is part way through a series of pages that are in memory, selecting a calculation from the [Calc(1)] or [Calc(2)] menu will create a new page in the series and delete everything after it. If you select a new calculation while page 3 of 5 is displayed, for example, the newly created page will become 4 of 4.

## Configuring Financial Application Settings

Most financial calculations require that you define certain general parameters that affect the results they produce. For example, you need to specify whether you use a 360-day or 365-day year, whether payments are made at the beginning of a period or end of a period, etc.

The following are settings required by the Financial application.

### Default settings

Configure default settings using the Financial Format dialog box. These settings are applied whenever you add a new page with the Financial application.

### Local settings

Configure local settings on the Format tab of each page, or by tapping the status bar. Local settings are applied to the currently displayed page only.

Local settings are generally applied to the currently displayed page only.

Note, however, that if you have one page displayed (Page A) and then add a new page (Page B), the initial settings of any Page B local setting items that are also on Page A will be those inherited from Page A. Default settings will be applied as the initial settings of items on Page B that are not also included on Page A.

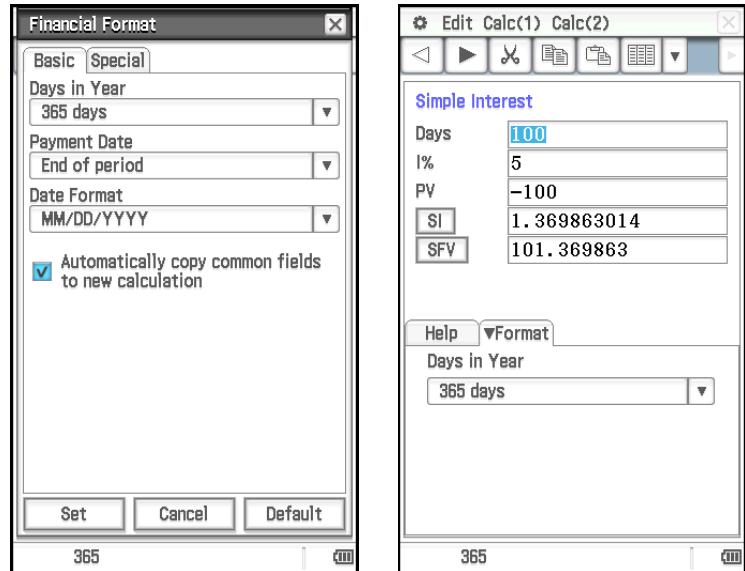

The table below shows setting items for each type of Financial calculation.

Setting Items	Financial Calculation					
	Simple Interest	Compound Interest	Amortization	Day Count	Bond Calculation	Break-even Point
Days in Year	Yes			Yes	Yes	
Payment Date		Yes	Yes			
Date Format				Yes	Yes	
Automatically copy common fields to new calculation	Yes	Yes	Yes	Yes	Yes	Yes
Odd Period		Yes				
Compounding Frequency					Yes	
Bond Interval					Yes	
Profit Amount/Ratio						Yes
Break-Even Value						Yes

- The “Date Format” and “Automatically copy common fields to new calculation” setting items in the above table can be configured on the Financial Format dialog box only.
- The “Automatically copy common fields to new calculation” option is automatically applied (and is the only option available) for any setting item that is not included in the above table.
- For details about each of the setting items, see “Financial Format Dialog Box” (page 41).

## 11-2 Performing Financial Calculations

The calculations in the table below can be performed with the Financial application. For actual calculation examples, refer to the sections of this manual or the separate “Examples” booklet shown in the “Example” column.

To perform this type of calculation:	Select this menu item:	Example
Interest without compounding based on the number of days money is invested	Calc(1) - Simple Interest	Page 186
Interest based on compounding parameters specified by you	Calc(1) - Compound Interest	<b>1101</b>
Value of money paid out or received in varying amounts over time	Calc(1) - Cash Flow	<b>1102</b>
Interest and principal portions of a payment or payments	Calc(1) - Amortization	<b>1103</b>
Effective or nominal interest rate for interest compounded multiple times during a year	Calc(1) - Interest Conversion	<b>1104</b>
Cost, selling price, or margin of profit on an item given the other two values	Calc(1) - Cost/Sell/Margin	<b>1105</b>
Number of days between two dates, or the date that is a specified number of days from another date	Calc(1) - Day Count	<b>1106</b>
Amount that a business expense can be offset by income (depreciated) over a given year	Calc(1) - Depreciation	<b>1107</b>
Purchase price or annual yield of a bond	Calc(1) - Bond Calculation	<b>1108</b>
Amount you must sell to break even or to obtain a specified profit, as well as amount of profit or loss on particular sales	Calc(2) - Break-Even Point	<b>1109</b>
How much sales can be reduced before incurring losses	Calc(2) - Margin of Safety	<b>1110</b>
Degree of change in net earnings arising from a change in sales amount	Calc(2) - Operating Leverage	<b>1111</b>
Degree of change in net earning arising from a change in interest paid	Calc(2) - Financial Leverage	<b>1112</b>
Combined effects of operating and financial leverages	Calc(2) - Combined Leverage	<b>1113</b>
Number of items sold, selling price, or sales amount given other two values; number of items manufactured, unit variable cost, or total variable cost given other two values	Calc(2) - Quantity Conversion	<b>1114</b>

## 11-3 Calculation Formulas

For information about terms used in formulas that are not explained in detail below, refer to “11-5 Input and Output Field Names”.

### Simple Interest

$$365\text{-day Mode: } SI' = \frac{\text{Days}}{365} \times PV \times i$$

$$360\text{-day Mode: } SI' = \frac{\text{Days}}{360} \times PV \times i$$

$$i = \frac{I\%}{100}$$

$$SI = -SI'$$

$$SFV = -(PV + SI')$$

## Compound Interest

### • When calculating PV, PMT, FV, n

$$I\% \neq 0 \quad PV = \frac{-\alpha \times PMT - \beta \times FV}{\gamma}$$

$$PMT = \frac{-\gamma \times PV - \beta \times FV}{\alpha}$$

$$FV = \frac{-\gamma \times PV - \alpha \times PMT}{\beta}$$

$$n = \frac{\log \left\{ \frac{(1+iS) \times PMT - FV \times i}{(1+iS) \times PMT + PV \times i} \right\}}{\log(1+i)}$$

$$I\% = 0$$

$$PV = -(PMT \times n + FV)$$

$$PMT = -\frac{PV + FV}{n}$$

$$FV = -(PMT \times n + PV)$$

$$n = -\frac{PV + FV}{PMT}$$

$$\alpha = (1+i \times S) \times \frac{1-\beta}{i}$$

	When "Odd Period" is "Off"	When "Odd Period" is "CI"	When "Odd Period" is "SI"
$\beta =$	$(1+i)^{-n}$	$(1+i)^{-Intg(n)}$	
$\gamma =$	1	$(1+i)^{Frac(n)}$	$1+i \times Frac(n)$
	When "Payment Date" is "End"	When "Payment Date" is "Begin"	
$S =$	0	1	
	When $P/Y = C/Y = 1$	When $P/Y \neq 1$ and/or $C/Y \neq 1$	
$i =$	$\frac{I\%}{100}$	$\left(1 + \frac{I\%}{100 \times [C/Y]}\right)^{\frac{C/Y}{P/Y}} - 1$	

### • When calculating I%

$i$  (effective interest rate) is calculated using Newton's Method.

$$\gamma \times PV + \alpha \times PMT + \beta \times FV = 0$$

$I\%$  is calculated from  $i$  using the formulas below:

	When $P/Y = C/Y = 1$	When $P/Y \neq 1$ and/or $C/Y \neq 1$
$I\% =$	$i \times 100$	$\left( (1+i)^{\frac{P/Y}{C/Y}} - 1 \right) \times C/Y \times 100$

Interest ( $I\%$ ) calculations are performed using Newton's Method, which produces approximate values whose precision can be affected by various calculation conditions. Interest calculation results produced by this application should be used keeping the above in mind, or results should be confirmed separately.

## Cash Flow

$$NPV = CF_0 + \frac{CF_1}{(1+i)} + \frac{CF_2}{(1+i)^2} + \frac{CF_3}{(1+i)^3} + \dots + \frac{CF_n}{(1+i)^n} \quad (i = \frac{I\%}{100}, n: \text{natural number up to } 80)$$

$$NFV = NPV \times (1+i)^n$$

$IRR$  is calculated using Newton's Method.

$$0 = CF_0 + \frac{CF_1}{(1+i)} + \frac{CF_2}{(1+i)^2} + \frac{CF_3}{(1+i)^3} + \dots + \frac{CF_n}{(1+i)^n}$$

In this formula,  $NPV = 0$ , and the value of  $IRR$  is equivalent to  $i \times 100$ . It should be noted, however, that minute fractional values tend to accumulate during the subsequent calculations performed automatically by the ClassPad, so  $NPV$  never actually reaches exactly zero.  $IRR$  becomes more accurate the closer that  $NPV$  approaches to zero.

$$PBP = \begin{cases} 0 & \dots\dots\dots (CF_0 \geq 0) \\ n - \frac{NPV_n}{NPV_{n+1} - NPV_n} & \dots \text{ (Other than those above)} \end{cases}$$

$$NPV_n = \sum_{k=0}^n \frac{CF_k}{(1+i)^k} \quad n: \text{smallest positive integer that satisfies the conditions } NPV_n \leq 0, 0 \leq NPV_{n+1}, \text{ or } 0$$

## Amortization

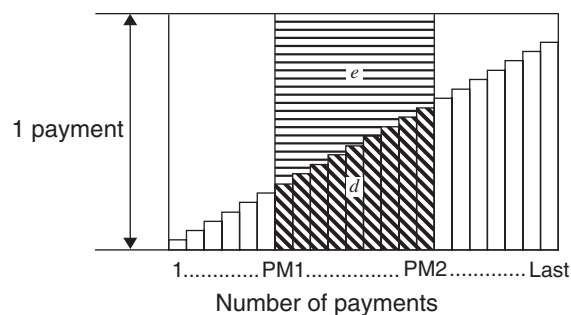
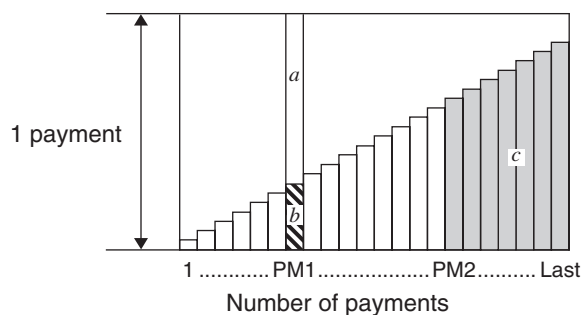

$a$ : interest portion of payment PM1 (INT)	$INT_{PM1} =  BAL_{PM1-1}  \times i \times (PMT \text{ sign})$
$b$ : principal portion of payment PM1 (PRN)	$PRN_{PM1} = PMT + BAL_{PM1-1} \times i$
$c$ : principal balance upon completion of payment PM2 (BAL)	$BAL_{PM2} = BAL_{PM2-1} + PRN_{PM2}$
$d$ : total principal paid from payment PM1 to payment PM2 ( $\Sigma PRN$ )	$\sum_{PM1}^{PM2} PRN = PRN_{PM1} + PRN_{PM1+1} + \dots + PRN_{PM2}$
$e$ : total interest paid from payment PM1 to payment PM2 ( $\Sigma INT$ )	$a + b = \text{one repayment (PMT)}$ $\sum_{PM1}^{PM2} INT = INT_{PM1} + INT_{PM1+1} + \dots + INT_{PM2}$ $BAL_0 = PV$ (when "Payment Date" is "End") $INT_1 = 0, PRN_1 = PMT$ (when "Payment Date" is "Begin")

## Converting between the Nominal Interest Rate and Effective Interest Rate

The nominal interest rate ( $I\%$  value input by user) is converted to an effective interest rate ( $I\%$ ) for installment loans where the number of annual payments is different from the number of annual compound calculation periods.

$$I\% = \left\{ \left( 1 + \frac{I\%}{100 \times [C/Y]} \right)^{\frac{[C/Y]}{[P/Y]}} - 1 \right\} \times 100$$

The following calculation is performed after conversion from the nominal interest rate to the effective interest rate, and the result is used for all subsequent calculations.

$$i = I\% \div 100$$

## Interest Conversion

$$EFF = \left[ \left( 1 + \frac{APR/100}{n} \right)^n - 1 \right] \times 100$$

$$APR = \left[ \left( 1 + \frac{EFF}{100} \right)^{\frac{1}{n}} - 1 \right] \times n \times 100$$

## Cost/Sell/Margin

$$CST = SEL \left(1 - \frac{MRG}{100}\right)$$

$$SEL = \frac{CST}{1 - \frac{MRG}{100}}$$

$$MRG(\%) = \left(1 - \frac{CST}{SEL}\right) \times 100$$

## Depreciation

### • Straight-Line Method

$$SL_1 = \frac{(PV - FV)}{n} \times \frac{YR1}{12}$$

$$SL_j = \frac{(PV - FV)}{n}$$

$$SL_{n+1} = \frac{(PV - FV)}{n} \times \frac{12 - YR1}{12} \quad (YR1 \neq 12)$$

### • Fixed-Percentage Method

$$FP_1 = PV \times \frac{I\%}{100} \times \frac{YR1}{12}$$

$$FP_j = (RDV_{j-1} + FV) \times \frac{I\%}{100}$$

$$FP_{n+1} = RDV_n \quad (YR1 \neq 12)$$

$$RDV_1 = PV - FV - FP_1$$

$$RDV_j = RDV_{j-1} - FP_j$$

$$RDV_{n+1} = 0 \quad (YR1 \neq 12)$$

### • Sum-of-the-Years'-Digits Method

$$Z = \frac{n(n+1)}{2}$$

$$n' = n - \frac{YR1}{12}$$

$$Z' = \frac{(\text{Intg}(n') + 1)(\text{Intg}(n') + 2) \times \text{Frac}(n')}{2}$$

$$SYD_1 = \frac{n}{Z} \times \frac{YR1}{12} (PV - FV)$$

$$SYD_j = \left(\frac{n' - j + 2}{Z'}\right) (PV - FV - SYD_1) \quad (j \neq 1)$$

$$SYD_{n+1} = \left(\frac{n' - (n+1) + 2}{Z'}\right) (PV - FV - SYD_1) \times \frac{12 - YR1}{12} \quad (YR1 \neq 12)$$

$$RDV_1 = PV - FV - SYD_1$$

$$RDV_j = RDV_{j-1} - SYD_j$$

### • Declining-Balance Method

$$DB_1 = PV \times \frac{I\%}{100n} \times \frac{YR1}{12}$$

$$RDV_1 = PV - FV - DB_1$$

$$DB_j = (RDV_{j-1} + FV) \times \frac{I\%}{100n}$$

$$RDV_j = RDV_{j-1} - DB_j$$

$$DB_{n+1} = RDV_n \quad (YR1 \neq 12)$$

$$RDV_{n+1} = 0 \quad (YR1 \neq 12)$$

## Bond Calculation

### • Terms in the formulas

*PRC*: price per \$100 of face value

*RDV*: redemption price per \$100 of face value

*CPN*: coupon rate (%)

*YLD*: annual yield (%)

*M*: number of coupon payments per year  
(1 = Annual, 2 = Semi-annual)

*N*: number of coupon payments until maturity (*n* is used when "Term" is specified for "Bond Interval".)

*INT*: accrued interest

*CST*: price including interest

*A*: accrued days

*D*: number of days in coupon period where settlement occurs

*B*: number of days from purchase date until next coupon payment date =  $D - A$

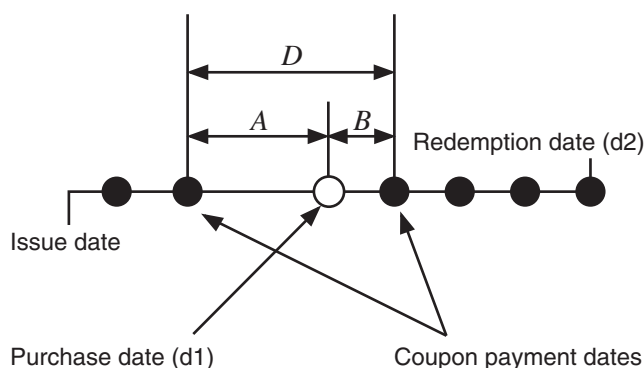



• **PRC when “Date” is specified for “Bond Interval”**

For one or fewer coupon period to redemption:

$$PRC = -\frac{RDV + CPN/M}{1 + (B/D \times (YLD/100)/M)} + A/D \times CPN/M$$

For more than one coupon period to redemption:

$$PRC = -\frac{RDV}{(1 + (YLD/100)/M)^{(N-1+B/D)}} - \sum_{k=1}^N \left( \frac{CPN/M}{(1 + (YLD/100)/M)^{(k-1+B/D)}} \right) + A/D \times CPN/M$$

$$INT = -A/D \times CPN/M \quad CST = PRC \times INT$$

• **PRC when “Term” is specified for “Bond Interval”**

$$PRC = -\frac{RDV}{(1 + (YLD/100)/M)^n} - \sum_{k=1}^n \left( \frac{CPN/M}{(1 + (YLD/100)/M)^k} \right) \quad INT = 0 \quad CST = PRC$$

• **YLD**

The Financial application performs annual yield (*YLD*) calculations using Newton’s Method, which produces approximate values whose precision can be affected by various calculation conditions. Because of this, annual yield calculation results produced by this application should be used keeping the above in mind, or results should be confirmed separately.

**Break-Even Point**

• **Profit (Profit Amount/Ratio Setting: Amount (PRF))**

$$QBE = \frac{FC + PRF}{PRC - VCU} \quad SBE = \frac{FC + PRF}{PRC - VCU} \times PRC$$

• **Profit Ratio (Profit Amount/Ratio Setting: Ratio (r%))**

$$QBE = \frac{FC}{PRC \times \left(1 - \frac{r\%}{100}\right) - VCU} \quad SBE = \frac{FC}{PRC \times \left(1 - \frac{r\%}{100}\right) - VCU} \times PRC$$

**Margin of Safety**

$$MOS = \frac{SAL - SBE}{SAL}$$

**Financial Leverage**

$$DFL = \frac{EBIT}{EBIT - ITR}$$

**Operating Leverage**

$$DOL = \frac{SAL - VC}{SAL - VC - FC}$$

**Combined Leverage**

$$DCL = \frac{SAL - VC}{SAL - VC - FC - ITR}$$

**Quantity Conversion**

$$SAL = PRC \times QTY \quad VC = VCU \times QTY$$

## 11-4 Financial Calculation Functions

ClassPad mathematical functions can be used to perform some Financial application calculations. ClassPad mathematical functions can be selected on the [Financial] submenu of the [Action] menu of the Main application or eActivity application.

The table below shows a list of mathematical functions that perform financial calculations. For descriptions of the arguments shown in each syntax and the values returned by each function, refer to “11-5 Input and Output Field Names”.

Financial Calculation	Function	Syntax	This function returns:
Simple Interest	simpInt	simpInt(Days,I%,PV)	SI
	simpFV	simpFV(Days,I%,PV)	SFV
Compound Interest	cmpdFV*1	cmpdFV(N,I%,PV,PMT,P/Y,C/Y)	FV
	cmpdIR*1	cmpdIR(N,PV,PMT,FV,P/Y,C/Y)	I%
	cmpdN*1	cmpdN(I%,PV,PMT,FV,P/Y,C/Y)	N
	cmpdPmt*1	cmpdPmt(N,I%,PV,FV,P/Y,C/Y)	PMT
	cmpdPV*1	cmpdPV(N,I%,PMT,FV,P/Y,C/Y)	PV
Cash Flow	cashIRR	cashIRR(Cash)	IRR
	cashNFV	cashNFV(I%,Cash)	NFV
	cashNPV	cashNPV(I%,Cash)	NPV
	cashPBP	cashPBP(I%,Cash)	PBP
Amortization	amortBal	amortBal(PM1,PM2,I%,PV,PMT,P/Y,C/Y)	BAL
	amortInt	amortInt(PM1,PM2,I%,PV,PMT,P/Y,C/Y)	INT
	amortPrn	amortPrn(PM1,PM2,I%,PV,PMT,P/Y,C/Y)	PRN
	amortSumInt	amortSumInt(PM1,PM2,I%,PV,PMT,P/Y,C/Y)	$\Sigma$ INT
	amortSumPrn	amortSumPrn(PM1,PM2,I%,PV,PMT,P/Y,C/Y)	$\Sigma$ PRN
Interest Conversion	convEff	convEff(N,I%)	EFF
	convNom	convNom(N,I%)	APR
Cost/Sell/ Margin	priceCost	priceCost(Sell,Margin)	Cost
	priceSell	priceSell(Cost,Margin)	Sell
	priceMargin	priceMargin(Cost,Sell)	Margin
Day Count	dayCount	dayCount(MM1,DD1,YYYY1,MM2,DD2,YYYY2)	Days
Bond Calculation	bondPriceDate*2	bondPriceDate(MM1,DD1,YYYY1,MM2,DD2,YYYY2,RDV,CPN,YLD)	{PRC,INT,CST}
	bondPriceTerm*3	bondPriceTerm(N,RDV,CPN,YLD)	{PRC,INT,CST}
	bondYieldDate*2	bondYieldDate(MM1,DD1,YYYY1,MM2,DD2,YYYY2,RDV,CPN,PRC)	YLD
	bondYieldTerm*3	bondYieldTerm(N,RDV,CPN,PRC)	YLD

\*1 P/Y and C/Y can be omitted. When they are omitted, calculations are performed using P/Y=1 and C/Y=1.

\*2 “Date” must be specified for the Financial Format “Bond Interval”.

\*3 “Term” must be specified for the Financial Format “Bond Interval”.

## 11-5 Input and Output Field Names



The list below shows the names of the input and output fields displayed on the various Financial application pages. When performing a calculation on your ClassPad, you can also get information using the [Help] tab.

<b>APR:</b> Nominal interest rate (as a percent)	<b>NFV:</b> Net future value
<b>BAL:</b> Balance of principal after PM2	<b>NPV:</b> Net present value
<b>C/Y:</b> Number of times interest is compounded per year	<b>P/Y:</b> Number of installment periods per year
<b>Cash:</b> List of income or expenses (up to 80 entries)	<b>PBP:</b> Payback period
<b>Cost (Cost/Sell/Margin):</b> Production cost	<b>PM1:</b> Number of first installment period in interval under consideration
<b>Cost (Bond Calculation):</b> Cost of bond (price plus partial year interest)	<b>PM2:</b> Number of last installment period in interval under consideration
<b>CPN:</b> Annual coupon rate	<b>PMT:</b> Amount paid each period
<b>d1:</b> Month (1-12); Day (1-31); Year (1902-2097)	<b>PRC (Bond Calculation):</b> Price of bond
<b>d2:</b> Month (1-12); Day (1-31); Year (1902-2097)	<b>PRC (Break-Even Point, Quantity Conversion):</b> Selling price per unit
<b>Days (Day Count):</b> Number of days from d1 to d2	<b>PRF:</b> Profit
<b>Days (Simple Interest):</b> Number of days in investment period	<b>PRN:</b> Principal portion of PM1
<b>DB:</b> Depreciation for year $j$ calculated using the declining-balance method	<b>PV:</b> Present value (initial investment)
<b>DCL:</b> Degree of combined leverage	<b>QBE:</b> Number of units to be sold
<b>DFL:</b> Degree of financial leverage	<b>QTY (Manufacturing):</b> Number of units manufactured
<b>DOL:</b> Degree of operating leverage	<b>QTY (Sales):</b> Number of units sold
<b>EBIT:</b> Earnings before interest and taxes	<b>r%:</b> Proportion of sales amount retained as a profit (as a percent)
<b>EFF:</b> Effective interest rate (as a percent)	<b>RDV (Bond Calculation):</b> Redemption value
<b>FC:</b> Fixed costs	<b>RDV (Depreciation):</b> Residual value after depreciation for year $j$
<b>FP:</b> Depreciation for year $j$ using the fixed-percentage method	<b>SAL:</b> Amount obtained from sales
<b>FV:</b> Future value	<b>SAL (Operating Leverage):</b> Amount currently obtained from sales
<b>I%:</b> Annual interest rate (as a percent)	<b>SBE (Break-Even Point):</b> Amount that must be obtained from sales to break even
<b>INT (Amortization):</b> Interest portion of PM1	<b>SBE (Margin of Safety):</b> Break-even sales (amount that must be obtained from sales to break even)
<b>INT (Bond Calculation):</b> Interest accumulated during partial year portion of investment period	<b>Sell:</b> Selling price
<b>INT (Financial Leverage, Combined Leverage):</b> Interest to be paid to bondholders	<b>SFV:</b> Simple future value (principal + interest)
<b>IRR:</b> Interest rate of return	<b>SI:</b> Simple interest
$j$ : Year for which depreciation is being calculated	<b>SL:</b> Depreciation for year $j$ using the straight-line method
<b>Margin:</b> Margin of profit (portion of selling price not absorbed by cost of production)	<b>sumINT:</b> Total interest paid from PM1 to PM2 (inclusive)
<b>MOS:</b> Margin of safety (portion of sales amount above break-even point)	<b>sumPRN:</b> Total principal paid from PM1 to PM2 (inclusive)
<b>N (Bond Calculation):</b> Number of periods	<b>SYD:</b> Depreciation for year $j$ using the sum-of-the-years'-digits method
<b>N (Compound Interest):</b> Number of installment periods	<b>VC:</b> Variable cost for a certain level of production
<b>N (Depreciation):</b> Number of years over which depreciation occurs	<b>VCU:</b> Variable cost per unit
<b>N (Interest Conversion):</b> Number of times interest is compounded per year	<b>YLD:</b> Yield to maturity (as a percent)
	<b>YR1:</b> Number of depreciable months in first year

# Chapter 12: Program Application

The Program application comes in handy when you need to perform the same calculation a number of times. You can create programs that automate graphing and other operations.

The Program application consists of a Program Editor for inputting and editing programs, and a Program Loader for loading and executing existing programs.

- The Program Loader window appears when you start up the Program application.
- To display the Program Editor window, tap  on the Program Loader window, or tap , [Window] and then [Program Editor].



Program Loader window



Program Editor window





**File type**  
 N: Program file  
 T: Text file  
 F: User-defined function file

## Program Application-Specific Menus and Buttons

### Program Loader window





- Display the Program Editor window .....  - Window - Program Editor, Edit - Open Editor or 
- Run a program ..... Run - Run Program or 

### Program Editor window

- Display the Program Loader window .....  - Window - Program Loader or 
- Save a file ..... Edit - Save File - Save or 
- Save a file under a new name ..... Edit - Save File - Save As
- Close a file ..... Edit - Close File
- Convert a file to a program file ..... Edit - Mode Change - ►Normal
- Convert a file to a text file ..... Edit - Mode Change - ►Text
- Convert a file to an edit prohibited program file ..... Edit - Compress
- Search for a newly specified text string ..... Edit - Search - New Search or 
- Search again for a previously specified text string ..... Edit - Search - Search Next or 
- Jump to the beginning/end of a program ..... Edit - Search - Jump to Top / Jump to Bottom

- Input a command (see “12-4 Program Command Reference”) ..... Ctrl, I/O, Misc

**Program Loader window and Program Editor window common commands**

- Display the Program Output window..... ⚙ - Window - Program Output or 
- Display the Text File Contents window ..... ⚙ - Window - Text File Contents
- Display the Main application work area window ..... ⚙ - Window - Main or 
- Create a new file ..... Edit - New File or 
- Open an existing file ..... Edit - Open File or 

## 12-1 Creating and Running Program

This section explains the steps you need to perform in order to create and run a program.

### Creating a Program

**Example:** To create a program named “OCTA” that uses the formulas below determines the surface area (S) and volume (V) of a regular octahedron

$$S = 2 \sqrt{3} A^2, \quad V = \frac{\sqrt{2}}{3} A^3$$

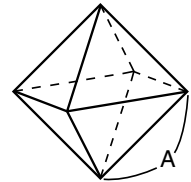

**• To create and save a new program**

1. On the Program Loader or Program Editor window, tap .
2. On the dialog box that appears, configure the settings for the new file as described below.
  - Leave the [Type] setting as “Program(Normal)”.
  - Tap the [Folder] down arrow button and then select the folder where you want to save the program file.
  - In the [Name] box, input up to eight bytes for the program file name. Here, we will input “OCTA”.
3. Tap [OK]. This displays a blank Program Editor window.

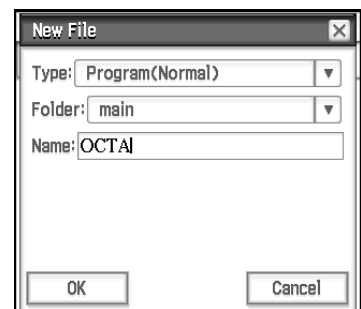

4. Input the necessary expressions and commands. Here, we will input the program shown in the nearby screenshot.
  - Each mathematical expression and command must be followed either by a carriage return or colon (:).
  - Use the menus shown below to input the “SetDecimal”, “Input”, and “Print” commands.

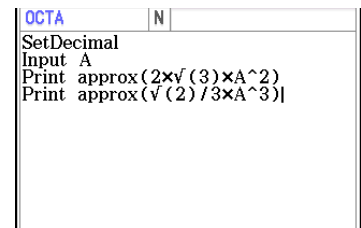

[Misc] - [Setup(1)] - [SetDecimal]  
 [I/O] - [Input] - [Input]  
 [I/O] - [Output] - [Print]

For information about the menus, syntax, operation, and other details about commands, see “12-4 Program Command Reference”.

- Calculation results of arguments that are input using the “approx(” function are displayed using rounded decimal parts. Use the soft keyboard for input.

5. After the program is the way you want, tap , or tap [Edit], [Save File] and then [Save] to save it.

- To run this program see “Running a Program” on page 199.
- If a message appears when you try to save the program, make the necessary corrections and try again. For details about making corrections to a program, see “12-2 Debugging a Program”.

**Tip**

- The file name you input in step 2 of the above procedure is subject to the same rules as folder and variable names. For more information, see “Folder and Variable Name Rules” on page 31.
- To input a program and save it without running it, perform the above procedure up to step 5, and then tap [Edit] and then [Close File].

If you want to use the calculation results produced by program execution in another calculation, include a line in the program that uses the “ $\Rightarrow$ ” command to assign the calculation result to a variable. For example, you could add the line below to the above example program to assign the calculated surface area to variable S and the volume to variable V.

$$2 \times \sqrt{(3)} \times A^2 \Rightarrow S; \sqrt{(2)/3} \times A^3 \Rightarrow V$$

Note that calculation results produced within programs are not stored in Ans memory.

**Pausing Program Execution**

You can specify where execution of a program should pause by including either a Pause command or a Wait command inside the program. For details about each command, see “12-4 Program Command Reference”.

**Configuring Parameter Variables and Inputting Their Values When Creating a Program**

If you input the names of variables used in a program into the parameter variable box when creating a program on the Program Editor window, you will be able to input values for the variables on the Program Loader window when you run the program.

**Example:**

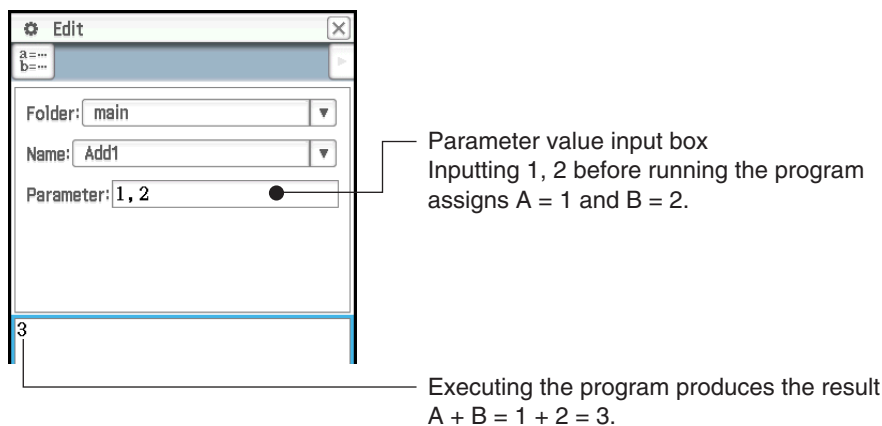
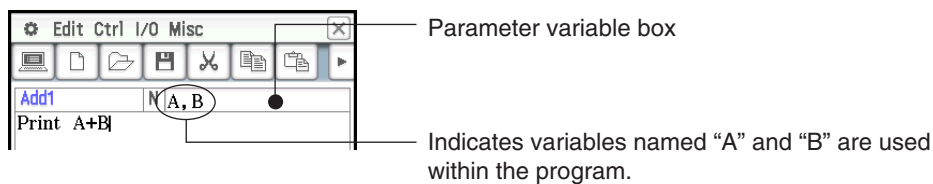

**Tip:** Variables that are specified as parameter variables within a program are automatically treated as local variables. For information about local variables, see “Local” in the “Command List” (page 214).

**Using a Subroutine to Call another Program**

Including the name of another program file inside of a program causes execution to jump to the specified program file.

Syntax: <program name>({<parameter variable name 1>,<parameter variable name 2>, ... })

The program that execution jumps from is called the “main program”, while the program to which execution jumps is called a “subroutine”.

When program execution returns to the main program, it resumes from the point immediately after the command that jumped to the subroutine.

**Example 1: Main Program:**

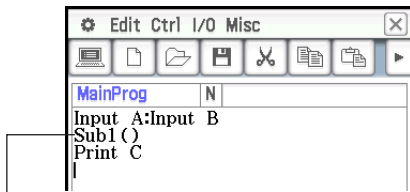

**Subroutine: "Sub1"**

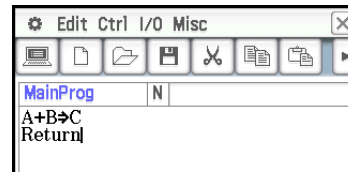

Jumps to subroutine program "Sub1"

**Example 2: Main Program:**

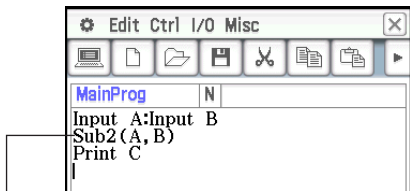

**Subroutine: "Sub2"**

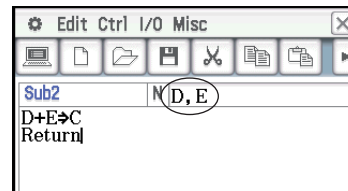

Assigns the values of main program variables "A" and "B" to the parameter variables (D and E) in subroutine "Sub2", and then jumps to subroutine "Sub2".

**Using Strings in a Program**

A string is a series of characters inside of quotation marks. In a program, strings are used to specify display text. A string made up of numbers (like "123") or an expression (like "x-1") cannot be processed as a calculation.

**Tip:** To include quotation marks (") or a backslash (\) in a string, put a backslash (\) in front of the quotation marks (") or backslash (\).

**Examples:**

To include Japan: "Tokyo" in a string  
 Print "Japan:\\"Tokyo\\""

To include main\abc in a string  
 Print "main\\abc"

**Running a Program**

**Example:** To run the "OCTA" program created under "Creating a Program" (page 197) to calculate the surface areas and volumes of three regular octahedrons, the lengths of whose sides are 7, 10, and 15

• **To run a program**

1. On the Program Loader window, specify the program you want to run.
  - (1) Tap the [Folder] down arrow button, and then select the folder you want.
  - (2) Tap the [Name] down arrow button, and then tap the name of the file.  
 Here, we will tap "OCTA".

- In this example, the "Parameter" input box is left blank. For information about using the "Parameter" input box, see "Configuring Parameter Variables and Inputting Their Values When Creating a Program" (page 198).

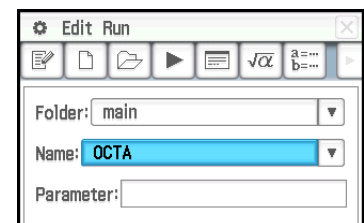

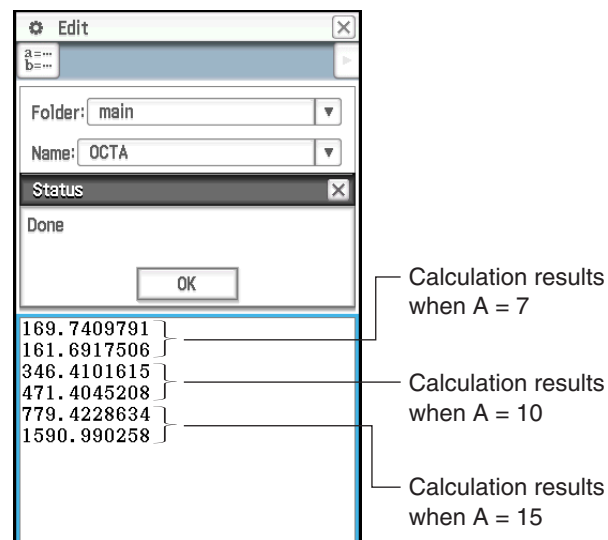

2. Tap [Run], or tap [Run] and then [Run Program] to run the program.
  - This runs the program and displays a dialog box prompting for input of a value for variable A (length of one side).

- Input a side length of 7 and tap [OK].
  - A Program Output window, showing the execution results of the program, will appear in the lower half of the screen.
  - On the “Done” dialog box that appears after program execution is complete, tap [OK].
- Tap the Program Loader window and repeat steps 2 and 3 for sides of length 10 and 15.





### Tip

- The Program Output window can be displayed by tapping , [Window] and then [Program Output], or by tapping  on the Program Loader window. The Program Output window also appears whenever the DispText command is executed in a program.
- Program Output window contents will remain displayed even if you run a different program. To clear the current contents, tap [Edit] - [Clear All] while the Program Output window is displayed. Executing the ClrText command also clears the currently stored Program Output window.
- You can run a program from the Main application or the eActivity application. For more information, see “2-12 Running a Program in the Main Application”.

## Terminating Program Execution

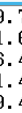

Pressing  while a program is running terminates the program.

**Tip:** Pressing  does not terminate the program if program execution is already paused by the Pause command (see “12-4 Program Command Reference”). In this case, tap  on the status bar to resume program execution, and then press .

## Creating a Text File

Use the procedure below to create a text file using the Program Editor window. You can also convert a previously saved program file to a text file.

### • To create and save a new text file

- On the Program Loader or Program Editor window, tap .
- On the dialog box that appears, configure the settings for the new file as described below.
  - Tap the [Type] down arrow button and then select “Program(Text)”.
  - Tap the [Folder] down arrow button and then select the folder where you want to save the text file.
  - In the [Name] box, input up to eight bytes for the text file name.
- Tap [OK]. This displays a blank Program Editor window.
- Input the text you want.
- After input is complete, tap , or tap [Edit], [Save File] and then [Save] to save it.

### • To change a program file to a text file

While a program file is open, tap [Edit], [Mode Change], and then .



**Tip:** Note that the above operation is not possible while a user-defined function (page 203) is open.

---

## Using Text Files

- Running a text file from the Program Loader window displays the contents of the file in the Text File Contents window.
- Inserting a text file name followed by “()” inside a program causes the contents of the text file to be displayed in the Text File Contents window when execution reaches the name.

**Example:**

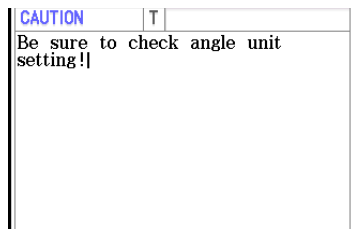

```
CAUTION | T
Be sure to check angle unit
setting!
```

File Name: “CAUTION”

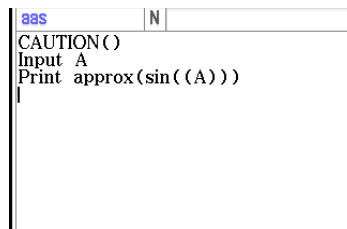

```
BAS | N
CAUTION()
Input A
Print approx(sin((A)))
```

Program that displays contents of “CAUTION” file

---

## Converting a Text File to a Program File

You can convert a text file created on the ClassPad to a program file. You also can transfer a text file created on your computer to a ClassPad unit, and then convert it to a program file.

### • To change a text file to a program file

While a text file is open, tap [Edit], [Mode Change], and then [►Normal].

#### **Tip**

- Note that the above operation is not possible while a user-defined function (page 203) is open.
- For information about transferring data between a computer and a ClassPad unit, see Chapter 19 of this manual.

---

## Converting a Program File to an Executable File

You can use the procedure below to change a program file (PRGM file type) to an executable file (EXE file type).

- An EXE file is about half the size as its corresponding PRGM file.
- An EXE file can only be executed. It cannot be edited. Because of this, converting a PRGM file to an EXE file also generates an editable PRGM file as a backup.

### • To convert a program file (PRGM) to an executable file (EXE)

1. Open the PRGM file that you want to convert and display it in the Program Editor window.
2. Tap [Edit] and then [Compress].
  - This displays a dialog box for inputting the backup file name.
3. Enter the backup file name and then tap [OK].
  - This saves two copies of the file. One is an EXE file under the name of the original PRGM file. The other is a backup file, which is created under the name you specify here.

Original File:           OCTA (type: PRGM)

Specified File Name: OCTA2

Resulting Files:       OCTA (type: EXE), OCTA2 (type: PRGM)

## 12-2 Debugging a Program

A programming error that causes a program to behave in a manner not intended by the writer of the program is called a “bug”. Finding and eliminating such errors is called “debugging the program”. Any of the following conditions can indicate that your program has a bug and requires debugging.

- If an error message appears when you try to save the program
- If an error message appears when you try to run the program
- If a program produces some abnormal or unexpected result

---

### Debugging After an Error Message Appears

When an error occurs, a dialog box appears to explain the cause of the error. Carefully read the text of the error message and then tap its [OK] button. This closes the dialog box, opens the Program Editor window, and positions the cursor at the location where the error occurred. Make the necessary corrections in accordance with the explanation provided by the error message.

**Tip:** EXE type files (page 201) cannot be edited. Tapping the [OK] button on the error dialog box will simply close the dialog box without displaying the Program Editor window. Open the backup PRGM file that was generated when you created the EXE file by converting it from a PRGM file, and use it for debugging.

---



### Debugging a Program Following Unexpected Results

If execution of a program produces unexpected or abnormal results, carefully read through the program and correct errors as required.

---

### Editing a Program

#### • To edit a program

1. On the Program Loader window, tap , or tap [Edit] and then [Open File].
2. On the dialog box that appears, select the program you want to edit, as described below.
  - Tap the [Type] down arrow button and then select “Program(Normal)”.
  - Tap the [Folder] down arrow button and then select the folder that contains the program you want to edit.
  - Tap the [Name] down arrow button, and then select the name of the program you want to edit.
3. Tap [OK].
4. Edit expressions and commands as required.
5. To overwrite the currently saved program with the edited version tap , or tap [Edit], [Save File] and then [Save].
  - To save the edited version of the program as a different program, use [Edit] - [Save File] - [Save As].

#### • To rename or delete a program

Programs are saved as variables, so you can rename and delete them using Variable Manager. For details, see “Using Variable Manager” (page 29).

## 12-3 User-defined Functions

ClassPad lets you configure calculation operations as user-defined functions, which can then be used inside of numeric expressions just like its built-in functions. User-defined functions can also be called up in other applications.

### Note

- User-defined functions are stored in ClassPad memory as “FUNC” (Function) type variables. Naming, storage, and folder rules are identical to those for user variables.
- A user-defined function can contain only a single mathematical expression.
- A user-defined function cannot contain any command.

---

### Creating a New User-defined Function



You can use either of the methods below to create user-defined functions.

- Using the Program application’s Program Editor window.
- Using the Main application’s Define command.

#### • To create and save a new user-defined function using the Program Editor window

**Example:** To create a user-defined function named “f4” that calculates the following:

$$x \times (x + 1) \times (x - 2)$$

1. On the Program Loader or Program Editor window, tap .
2. On the dialog box that appears, configure the settings for the new file as described below.
  - Tap the [Type] down arrow button and then select “Function”.
  - Tap the [Folder] down arrow button and then select the folder where you want to save the user-defined function.
  - In the [Name] box, input up to eight bytes for the user-defined function name. Here, we will input “f4”.
3. Tap [OK]. This displays a blank Program Editor window.
4. Input user-defined function arguments into the parameter variable box. Here, we will input “x”.
5. Input the expression you want. Here, we will input “ $x \times (x + 1) \times (x - 2)$ ”.
6. After the function is the way you want, tap , or tap [Edit], [Save File] and then [Save] to save it.

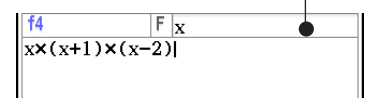

Parameter variable box



#### • To create a user-defined function using the Define command

**Example:** To create a user-defined function named “f2” that calculates the following:

$$2x + 3y + 1$$

1. On the Program Loader window, tap , or tap , [Window] and then [Main] to display the Main application window.
  - You could also tap  on the icon panel to start up the Main application.
2. Tap [Interactive] and then [Define].
3. On the dialog box that appears, input the following.
  - [Func name]: “f2”
  - [Variable/s]: “x, y”
  - [Expression]:  $2x + 3y + 1$

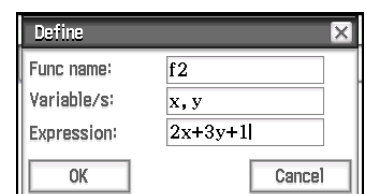

4. Tap [OK].

- This will cause the Define command to be executed in accordance with your specifications, which will save user-defined function “f2”.

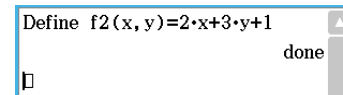

**Tip:** For information about the syntax of the Define command, see “Define” in the “Command List” (page 208).

---

## Executing a User-defined Function

**Example:** To use the Main application to execute user-defined functions “f4” and “f2” that were created under “Creating a New User-defined Function”

As shown in the nearby screenshot, input the required arguments for each variable name and then press **EXE** to execute.

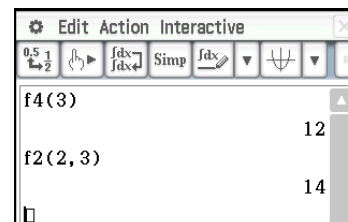



**Tip:** User-defined functions are displayed on the catalog keyboard. You can change the keyboard view to show only user-defined functions by tapping the catalog keyboard [Form] down arrow button and then selecting [User].

---

## Editing a User-defined Function

### • To edit a user-defined function

1. On the Program Loader window, tap , or tap [Edit] and then [Open File].
2. On the dialog box that appears, select the function you want to edit, as described below.
  - Tap the [Type] down arrow button and then select “Function”.
  - Tap the [Folder] down arrow button and then select the folder that contains the function you want to edit.
  - Tap the [Name] down arrow button, and then select the name of the function you want to edit.
3. Tap [OK].
4. Edit the expression and/or parameter variables as required.
5. To overwrite the currently saved function with the edited version tap , or tap [Edit], [Save File] and then [Save].
  - To save the edited version of the function as a different program, use [Edit] - [Save File] - [Save As].

### • To rename or delete a user-defined function

User-defined functions are saved as variables, so you can rename and delete them using Variable Manager. For details, see “Using Variable Manager” (page 29).

# 12-4 Program Command Reference

## Using This Reference

- This reference lists ClassPad commands in alphabetical order. Commands that do not use alphabetic characters (such as ⇒ and #) are at the top of the list.
- To the right of each command name is shown the Program Editor window menu sequence that you need to use to input the command. For example, to input the “Break” command you would tap [Ctrl], then [Control], then [Break].



If a command has **Keyboard** to the right, it means that the command can be input from the soft keyboard only.

- Command names inside of explanation text are shown in bold.

## Syntax Conventions

The table below explains each of the symbols that are used inside of command syntax.

Symbol	Meaning
□	This indicates a space. Always make sure you input one space between a command and its parameters. Example: GetKey□<variable name>
{ }	You need to select one of the multiple options enclosed inside the braces ({ }). Example: {On ; Off ; Number} When inputting the command, do not include the braces or semicolons.
[ ]	Anything inside brackets ([ ]) is optional. You can input the item inside the brackets or omit it. When inputting the command, do not include the brackets.
...	The term to the left of ellipsis (...) can be input more than once or repeated.
" "	Characters inside of parentheses (" ") are a character string.
< >	You should input what is described inside the angle brackets (< >). When inputting the command, do not include the angle brackets. Example: <variable>, <variable name>, <expression>, <integer from 0 to 9>

---

## Command List

### Symbols

#### **(Carriage Return)** Keyboard

Function: Performs a carriage return operation.

Description: In Program Editor, press the **[EXE]** key to input a carriage return.

- The carriage return can be used in a user program. It cannot, however, be used in a manual calculation performed in the Main application.

#### **: (Multi-statement Command)** Ctrl

Function: Use this command to link a series of statements into a multi-statement (on a single line).

Description: The multi-statement command can be used in a user program. It cannot, however, be used in a manual calculation performed in the Main application.

#### **⇒** Ctrl

Syntax 1: {<expression> ; "<string>"} ⇒ <variable name>

Syntax 2: {<expression> ; "<string>"} ⇒ <list element>

Syntax 3: <expression> ⇒ <matrix element>

Function: The content of the expression on the left is evaluated, and the result is assigned to the item on the right.

#### **' (Comment)** Ctrl - Misc

Function: Any text following this symbol is not executed. You can use this command to include comment text in your program.

Description: Any line that starts with the comment symbol (') is treated as comment text, which is skipped during program execution.

#### **" (quotation mark)** Ctrl - Misc

Function: Any text inside of quotation marks is treated as a string.

#### **=** Ctrl - Logic

Syntax: <expression 1> = <expression 2>

Function: Returns true when <expression 1> and <expression 2> are equal, and returns false when they are not.

#### **≠** Ctrl - Logic

Syntax: <expression 1> ≠ <expression 2>

Function: Returns true when <expression 1> and <expression 2> are not equal, and returns false when they are.

#### **<** Ctrl - Logic

Syntax: <expression 1> < <expression 2>

Function: Returns true when <expression 1> is less than <expression 2>, and returns false when <expression 1> is equal to or greater than <expression 2>.

#### **>** Ctrl - Logic

Syntax: <expression 1> > <expression 2>

Function: Returns true when <expression 1> is greater than <expression 2>, and returns false when <expression 1> is equal to or less than <expression 2>.

#### **≤** Ctrl - Logic

Syntax: <expression 1> ≤ <expression 2>

Function: Returns true when <expression 1> is less than or equal to <expression 2>, and returns false when <expression 1> is greater than <expression 2>.

#### **≥** Ctrl - Logic

Syntax: <expression 1> ≥ <expression 2>

Function: Returns true when <expression 1> is greater than or equal to <expression 2>, and returns false when <expression 1> is less than <expression 2>.

#### **#** Misc - String(2)

Syntax: # <string variable name>

Function: This command specifies a string variable whose string is a variable name.

Example 1: When the content of variable *exp1* is  $\pi$  and the content of variable *str1* is "exp1",  $\sin(\#str1)$  calculates  $\sin(\pi)$ .

Example 2: To cause a folder to be created during program execution:

InputStr□name, "Foldername" : NewFolder□#name

### A

#### **abExpReg (abExpR)** Misc - Statistics(1) - Regression

Syntax: abExpReg□xList, yList[, [FreqList (or 1)] [, [*yn*] [, {On ; Off}]]]

Function: Performs  $y = a \cdot b^x$  regression.

Description: See **SinReg**.

#### **and** Ctrl - Logic

See "Bitwise Operations" (page 60).

### B

#### **BinomialPD** Keyboard

Syntax: BinomialPD□x value, Numtrial value, *pos* value

Function: See "Binomial Distribution Probability" (page 152).

**BinomialCD** Keyboard

Syntax: BinomialCD  $\square$  Lower value, Upper value, Numtrial value, *pos* value

Function: See “Binomial Cumulative Distribution” (page 152).

**Break** Ctrl - Control

Syntax: Break

Function: This command terminates a loop and causes execution to advance to the next command following the loop process.

Description:

- **Break** terminates a loop and causes execution to advance to the next command following the loop process.
- **Break** can be used inside of a **For**, **Do**, **While**, or **Switch** process.

**Broken** Misc - Statistics(1) - Graph

Function: Used as a **StatGraph** command argument to specify an option. See **StatGraph**.

**C****CallUndef** Misc - Graph&Table(1)

Function: Used as a **ViewWindow** command argument to specify an option. See **ViewWindow**.

**Case** Ctrl - Switch

See **Switch~Case~Default~SwitchEnd**.

**ChiCD** Keyboard

Syntax: ChiCD  $\square$  Lower value, Upper value, *df* value

Function: See “ $\chi^2$  Cumulative Distribution” (page 152).

**ChiPD** Keyboard

Syntax: ChiPD  $\square$  *x* value, *df* value

Function: See “ $\chi^2$  Probability Density” (page 152).

**ChiGOFTest** Keyboard

Syntax: ChiGOFTest  $\square$  <Observed list name>, <Expected list name>, *df* value

Function: See “ $\chi^2$  GOF Test” (page 148).

**ChiTest** Keyboard

Syntax: ChiTest  $\square$  <Observed matrix name>

Function: See “ $\chi^2$  Test” (page 148).

**ChrToNum** Misc - String(1)

Syntax: ChrToNum  $\square$  "<string>", <storage variable name>[,*n*]

Function: Converts the characters up to the *n*th character of a string to their character code values and assigns the string to the specified variable.

Description: Omitting “*n*” starts conversion from the first character of the string. For information about character codes, see “Character Code Table” on page 295.

**Circle** I/O - Sketch

Syntax: Circle  $\square$  <center *x*-coordinate>, <center *y*-coordinate>, radius[,<color command>]

Function: Draws a circle.

**Clear\_a\_z** Misc - Variable

Syntax: Clear\_a\_z  $\square$  [<folder name>]

Function: Deletes all single letter lower-case named variables from *a* through *z* from the specified folder.

Description:

- If you don't specify a folder name, the variables of the current folder are cleared.
- Deletes all variables from *a* through *z*, regardless of type (program, etc.). See **GetType** for information about variable types.
- Keep in mind that this command clears all data types, including programs, functions, etc.

**ClearSheet** Misc - Graph&Table(1) - Sheet

Syntax: ClearSheet [{<sheet number> ; "<sheet name>"}]

Function: Deletes the sheet name and expressions on the sheet, and returns its settings to their default values. Omitting the argument causes all sheets to be cleared.

**CloseComPort38k** I/O - Communication

Syntax: CloseComPort38k

Function: Closes the 3-pin COM port.

**ClrGraph** I/O - Clear

Syntax: ClrGraph

Function: Clears the Graph window and returns View Window parameters to their initial default settings.

**ClrPict** Misc - Graph&Table(2)

Syntax: ClrPict

Function: Clears an image recalled by the RclPict command.

**ClrText** I/O - Clear

Syntax: ClrText

Function: Clears text from the Program Output window.

**Cls** I/O - Clear

Syntax: Cls

Function: Clears sketch elements (lines and other figures sketched on the Graph window), and graphs drawn using drag and drop.

**ColorBlack, ColorBlue, ColorRed, ColorMagenta, ColorGreen, ColorCyan, ColorYellow** I/O - Color

Function: Used as arguments of certain commands to specify colors.

Description: The following commands use these arguments: **DrawShade, DrawGraph, TangentLine, NormalLine, Inverse, Plot, PlotOn, PlotChg, Line, Circle, Vertical, Horizontal, Text, PxlOn, PxlChg, Print, Locate, SetGraphColor, SetSketchColor**

Example: Text 10, 10, "CASIO", ColorBlue

**CopyVar** Misc - Variable

Syntax: CopyVar□<source variable name>, <copy destination variable name>

Function:

- Copies the contents of a variable to another variable.
- If the copy destination variable has the same name as the source variable name, the destination variable is replaced with the source variable.

**Cross** Misc - Statistics(2)

Function: Used as a **StatGraph** command argument to specify an option. See **StatGraph**.

**CubicReg (CubicR)** Misc - Statistics(1) - Regression

Syntax: CubicReg□xList, yList[, [FreqList (or 1)] [, [<yn>][, {On ; Off}]]]

Function: Performs  $y = a \cdot x^3 + b \cdot x^2 + c \cdot x + d$  regression.

Description: See **SinReg**.

## D

**DateMode360** Keyboard

Syntax: DateMode360

Function: Specifies a 360-day year for financial calculations.

**DateMode365** Keyboard

Syntax: DateMode365

Function: Specifies a 365-day year for financial calculations.

**Default** Ctrl - Switch

See **Switch~Case~Default~SwitchEnd**.

**DefaultListEditor** Misc - Statistics(2)

Syntax: DefaultListEditor

Function: Initializes the sort sequence and display contents of the list on the Stat Editor window (list1 to list6).

**DefaultSetup** Misc - Setup(1)

Syntax: DefaultSetup

Function: Initializes all setup data settings.

**Define** Ctrl - Misc

Syntax: Define□[<folder name>\ ]<function name> ([<variable name>[, <variable name>...]]) =<expression>

- If you do not specify a folder name, the function is stored in the current folder.

Function: Creates a user-defined function.

Description: See "To create a user-defined function using the Define command" on page 203.

**DelFolder** Misc - Variable - Folder

Syntax: DelFolder□<folder name>

Function: Deletes a folder.

**DelVar** Misc - Variable

Syntax: DelVar□<variable name>, <variable name> ...

Function: Deletes a variable.

Description: Deletes all variables, regardless of type (program, etc.), that have the specified variable name. See **GetType** for information about variable types.

**DispDfrTbl** I/O - Display

Syntax: DispDfrTbl

Function: Creates and displays an arithmetic sequence table.

**DispDQTbl** I/O - Display

Syntax: DispDQTbl

Function: Creates and displays a progression of difference table.

**DispFibTbl** I/O - Display

Syntax: DispFibTbl

Function: Creates and displays a Fibonacci sequence table.

**DispFTable** I/O - Display

Syntax: DispFTable

Function: Creates and displays a function table.

**DispListEditor** I/O - Display

Syntax: DispListEditor

Function: Displays the Stat Editor window.

**DispQutTbl** I/O - Display

Syntax: DispQutTbl

Function: Creates and displays a geometric sequence table.

**DispSeqTbl** I/O - Display

Syntax: DispSeqTbl

Function: Creates and displays a recursion table.

**DispSmryTbl** I/O - Display

Syntax: DispSmryTbl

Function: Creates and displays a summary table.



**DispStat** I/O - Display

Syntax: DispStat

Function: Displays previous statistical calculation results.

**DispText** I/O - Display

Syntax: DispText

Function: This command displays the Program Output window.

Description: You can use this command to re-display the Program Output window following display of the Graph window, Table window, or other window.

Example: To re-display the Program Output window after it has been cleared by a graphing operation or some other operation

GraphType "y=": Define  $y_1(x) = \sqrt{x}$ : GTSelOn 1

ViewWindow : 0⇒FStart : 10⇒FEnd : 1⇒FStep

ClrText ← *Initializes the Program Output window.*

Print " $y_1(x) = \sqrt{x}$ " ← *Displays the graph expression on the Program Output window.*

Print "Tap Continue button." ← *Tells user what to do to continue program execution after reading the message.*

Pause ← *Pauses program execution to allow user to read Program Output window message.*

DrawGraph ← *Draws the graph.*

DispFTable ← *Displays the table.*

Pause ← *Pauses program execution to allow for graph and table editing. Program Output window is not displayed at this time.*

DispText ← *Re-displays the Program Output window.*

Pause ← *Pauses program execution to allow user to read Program Output window message.*

**Distance** I/O - Sketch

Syntax: Distance□<x-coordinate 1>, <y-coordinate 1>, <x-coordinate 2>, <y-coordinate 2>

Function: Determines the distance between two points.

Description: Executing this command makes the Graph window active, displays pointers at the locations of coordinates 1 and 2, and displays the distance between the pointers.

**Tip:** An error occurs if <x-coordinate> or <y-coordinate> is outside of the current Graph window.

**Do~LpWhile** Ctrl - Do

Syntax: Do : [<statement>] ... : LpWhile□<expression>

- <expression> is a condition that evaluates to true or false.

Function: The specified statements are repeated as long as the condition is true.

Description:

- The statements between **Do~LpWhile** are repeated as long as the condition is true. When the condition becomes false, execution jumps to the next command after the **LpWhile** command.
- Since the condition comes after **LpWhile**, the condition is not evaluated until the end of the loop is reached.
- You can use a multi-statement command (:) in place of the carriage return to separate statements.
- Do not use the **Goto** command to exit a **Do~LpWhile** loop.

**Dot** Misc - Statistics(2)

Function: Used as a **StatGraph** command argument to specify an option. See **StatGraph**.

**DrawConics** I/O - Draw

Syntax: DrawConics

Function: Draws a conics graph based on the data registered on the Conics Editor window.

**DrawFTGCon, DrawFTGPlot** I/O - Draw

Syntax: DrawFTGCon  
DrawFTGPlot

Function: Graphs a function using a generated number table, in accordance with the conditions of each command.

Description: FTG stands for "Function Table Graph". **DrawFTGCon** draws a connect type graph, while **DrawFTGPlot** draws a plot type graph.

**DrawGraph** I/O - Draw

Syntax: DrawGraph□[<expression>][,<color command>]

Function: Graphs the selected expression or an expression specified as a parameter.

Description: <expression> has a y= type expression on the right side. Graphing of any other type of expression is not supported by this command.

**DrawSeqCon, DrawSeqPlt** I/O - Draw

Syntax: DrawSeqCon  
DrawSeqPlt

Function: Graphs a recursion expression whose vertical axis is  $a_n$  ( $b_n$  or  $c_n$ ) and whose horizontal axis is  $n$  using a generated number table, in accordance with the conditions of each command.

Description: **DrawSeqCon** draws a connect type graph, while **DrawSeqPlt** draws a plot type graph.

**DrawSeqEtrCon, DrawSeqEtrPlt** I/O - Draw

Syntax: DrawSeqEtrCon  
DrawSeqEtrPlt

Function: Graphs a recursion expression whose vertical axis is  $\Sigma a_n$  ( $\Sigma b_n$  or  $\Sigma c_n$ ) and whose horizontal axis is  $n$  using a generated number table, in accordance with the conditions of each command.

Description: **DrawSeqEtrCon** draws a connect type graph, while **DrawSeqEtrPlt** draws a plot type graph.

**DrawShade** I/O - Draw

Syntax: DrawShade□<expression 1>, <expression 2>[, <number 1>, <number 2>][,<color command>]

Function: Shades the area between expression 1 (lower curve) and expression 2 (upper curve) from  $x$ -values of number 1 to number 2.

Description: Expression 1 and expression 2 have a  $y=$  type expression on the right side. Graphing of any other type of expression is not supported by this command.

**DrawStat** I/O - Draw

Syntax: DrawStat

Function: Draws a statistical graph.

**E****Else** Ctrl - If

See **If~Then~Else~Else~IfEnd**.

**Elseif** Ctrl - If

See **If~Then~Elseif~Else~IfEnd**.

**ExpReg (ExpR)** Misc - Statistics(1) - Regression

Syntax: ExpReg□ $x$ List,  $y$ List[, [FreqList (or 1)]], [< $yn$ >] [, {On ; Off}]

Function: Performs  $y = a \cdot e^{b \cdot x}$  regression.

Description: See **SinReg**.

**ExpToStr** Misc - String(1)

Syntax: ExpToStr□<expression>, <storage variable name>

Function: Converts the result of an input expression to a string and assigns the string to the specified variable.

**F****FCD** Keyboard

Syntax: FCD□Lower value, Upper value,  $n:df$  value,  $d:df$  value

Function: See “ $F$  Cumulative Distribution” (page 152).

**FPD** Keyboard

Syntax: FPD□ $x$  value,  $n:df$  value,  $d:df$  value

Function: See “ $F$  Probability Density” (page 152).

**For~To~(Step~)Next** Ctrl - For

Syntax:

For□<expression 1>=><control variable name>□

To□<expression 2> [Step□<expression 3>]

[<statement>] ... : Next

- <expression 1> is the initial value, <expression 2> is the end value, and <expression 3> is the step.

Function: Anything between the **For** command and the **Next** command is repeated for a count starting with the initial value of the control variable and ending when the control variable reaches the end value.

Each pass causes the value of the control variable to be changed by the value specified by the step value.

The loop is terminated whenever the control variable value exceeds the end value.

Description:

- 1 is used for the step if a step value is not specified.
- The initial value can be less than the end value, as long as a positive value is specified for the step. In this case, the value of the control value is increased by the step with each pass.
- The initial value can be greater than the end value, as long as a negative value is specified for the step. In this case, the value of the control value is decreased by the step with each pass.
- You can use a multi-statement command (:) in place of the carriage return to separate statements.
- Do not use the **Goto** command to exit a **For~Next** loop.

**G****GeoCD** Keyboard

Syntax: GeoCD□Lower value, Upper value,  $pos$  value

Function: See “Geometric Cumulative Distribution” (page 153).

**GeoPD** Keyboard

Syntax: GeoPD□ $x$  value,  $pos$  value

Function: See “Geometric Distribution Probability” (page 153).

**GetFolder** Misc - Variable - Folder

Syntax: GetFolder□<storage variable name>

Function: Gets the current folder name and assigns it to a variable as a text string.

**GetKey** I/O - Input

Syntax: GetKey□<variable name>

Function: This command assigns the code number of the last key pressed to the specified variable.

Description:

- This command assigns the code number of the last key pressed to the specified variable. The following shows a list of available code numbers.

Key	Code	Key	Code	Key	Code
0	48	+	43	^	94
1	49	=	45	EXE	13
2	50	X	60944	▲	28
3	51	÷	47	▼	29
4	52	=	61	◀	30
5	53	(	40	▶	31
6	54	)	41	Keyboard	144
7	55	,	44	←	145
8	56	(-)	45	Shift	8
9	57	x	60856	Clear	12
.	46	y	60857		
EXP	147	z	60858		

- 0 is assigned to the variable if no key was pressed.

**GetPen** I/O - Input

Syntax: GetPen□<variable name 1>, <variable name 2>

Function: This command assigns the coordinates of the point tapped on the screen to a specified variable.

Description: This command assigns the *x*-coordinate (horizontal axis) to <variable 1> and the *y*-coordinate (vertical axis) to <variable 2>. The coordinates at the point in the upper left corner of the screen are (1, 1), and coordinate values are specified in the range of 1 to 320 for the *x*-coordinate and 1 to 528 for the *y*-coordinate.

**GetType** Misc - Variable

Syntax: GetType□<variable name>, <storage variable name>

Function: Gets the type of the specified variable and assigns it to a storage variable as a text string.

Description: The following is a list of variable types.

- NUM\*<sup>1</sup>
- MAT
- FUNC
- MEM
- EXPR\*<sup>2</sup>
- PRGM
- PICT
- OTHR
- STR
- EXE
- GMEM
- NONE\*<sup>3</sup>
- LIST
- TEXT
- GEO

\*1 Real number \*2 Expression

\*3 No applicable variable

For details about each type, see "Main Memory Data Types" (page 28).

**GetVar38k** I/O - Communication

Syntax: GetVar38k□<variable name>

Function: Receives variable names and variable contents.

Description:

- The **OpenComPort38k** command must be executed before this command is executed.
- The **CloseComPort38k** command must be executed after this command is executed.

**Goto~Lbl** Ctrl - Jump

Syntax: Goto□<label name> : Lbl□<label name>

Function: This command causes program execution to jump to a specific location.

Description:

- <label name> is a text string that is subject to the same rules as variable names.
- **Goto** and **Lbl** are used in pairs. Program execution jumps from **Goto** to the **Lbl** with the same label name. A single **Lbl** can be used as the jump destination of multiple **Goto** commands.
- This command can be used to loop back to the beginning of a program or to jump to any location within the program.
- An error occurs if ClassPad is unable to find a **Lbl** with the same label as **Goto**.
- Note that the # command cannot be used in a label name.

**GraphType** Misc - Graph&Table(1)

Syntax: GraphType□"y=" ; "r=" ; "xt=" ; "x=" ; "y>" ; "y<" ; "y≥" ; "y≤" ; "x>" ; "x<" ; "x≥" ; "x≤"

Function: Specifies the graph expression input type.

**GTSelOff** Misc - Graph&Table(1)

Syntax: GTSelOff□<graph number>

Function: Deselects a graph expression.

Description: Graph number range: 1 to 100

**GTSelOn** Misc - Graph&Table(1)

Syntax: GTSelOn□<graph number>

Function: Selects a graph expression.

Description: Graph number range: 1 to 100

**H****Histogram** Misc - Statistics(1) - Graph

Function: Used as a **StatGraph** command argument to specify an option. See **StatGraph**.

**Horizontal** I/O - Sketch

Syntax: Horizontal□<y-coordinate>[, <color command>]

Function: Draws a horizontal line.

## HypergeoCD

Keyboard

Syntax: HypergeoCD  $\square$  Lower value, Upper value,  $n$  value,  $M$  value,  $N$  value

Function: See "Hypergeometric Cumulative Distribution" (page 153).

## HypergeoPD

Keyboard

Syntax: HypergeoPD  $\square$   $x$  value,  $n$  value,  $M$  value,  $N$  value

Function: See "Hypergeometric Distribution Probability" (page 153).

/

## If~Then~Else~Else~IfEnd

Ctrl - If

Syntax 1: If  $\square$  <expression> : Then : [<statement>] ... : IfEnd

Function 1:

- If the expression is true, the statement in the **Then** block is executed. After that, execution advances to the next statement after **IfEnd**.
- If the expression is false, execution advances to the next statement after **IfEnd**, without executing the statement in the **Then** block.

Syntax 2: If  $\square$  <expression> : Then : [<statement>] ... : Else : [<statement>] ... : IfEnd

Function 2:

- If the expression is true, the statement in the **Then** block is executed. After that, execution advances to the next statement after **IfEnd**.
- If the expression is false, the statement in the **Else** block is executed instead of the **Then** block. After that, execution advances to the next statement after **IfEnd**.

Syntax 3: If  $\square$  <expression> : Then : [<statement>] ... : Elseif  $\square$  <expression> : Then : [<statement>] ... : IfEnd

Function 3:

- If the expression is true, the statement in the **If Then** block is executed. After that, execution advances to the next statement after **IfEnd**.
- If the **If** command expression is false, the **Elseif** command expression is tested. If it is true, the statement in the **Elseif Then** block is executed. After that, execution advances to the next statement after **IfEnd**. If it is false, execution advances to the next statement after **IfEnd**.

Syntax 4: If  $\square$  <expression> : Then : [<statement>] ... : Elseif  $\square$  <expression> : Then : [<statement>] ... : Else : [<statement>] ... : IfEnd

Function 4:

- If the expression is true, the statement in the **If Then** block is executed. After that, execution advances to the next statement after **IfEnd**.
- If the **If** command expression is false, the **Elseif** command expression is tested. If it is true, the statement in the **Elseif Then** block is executed. After that, execution advances to the next statement after **IfEnd**. If it is false, the **Else** block statement is

executed. After that, execution advances to the next statement after **IfEnd**.

Description:

- With all four of the syntaxes described above, you can use a multi-statement command (:) in place of the carriage return to separate **Then** block statements.
- The **If~IfEnd** command can be nested.
- The **If~IfEnd** loop can be exited using the **Break** command or **Return** command.
- Do not use the **Goto** command to exit an **If~IfEnd** loop.

## IfEnd

Ctrl - If

See **If~Then~Else~Else~IfEnd**.

## Input

I/O - Input

Syntax: Input  $\square$  <variable name>[, "<string 1>"[, "<string 2>"]]

Function: When program execution reaches the **Input** command, the user is prompted for input of a value, which is assigned to the specified variable.

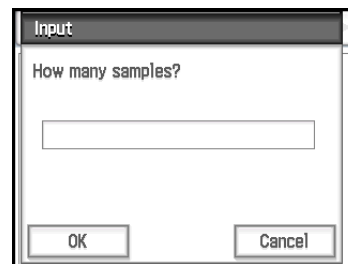

Description:

- If you do not specify anything for "<string 1>", the prompt "<variable name>?" appears by default.
- The text specified for "<string 2>" is used as the input dialog box title.
- This command pauses program execution and displays a dialog box that contains the text string indicated by "<string 1>" and an input box. A text string enclosed within quotation marks (") or a variable name can be specified for "<string 1>".
- Specifying a long text string can cause part of it to be cut off when it is displayed in the dialog box.
- When the dialog box appears, input a value into the input box and then tap [OK]. This closes the dialog box, assigns the input value to the applicable variable and resumes program execution.
- Tapping [Cancel] on the dialog box terminates program execution.

Note:

- During execution of the **Input** command, program execution is paused for input of data. While a program is paused, you can input individual mathematical expressions only. You cannot input commands or a series of statements joined by colons (:).

**InputFunc** I/O - Input

Syntax: InputFunc□<user-defined function name> (<argument >[,<argument >...]) [, "<string 1>"[, "<string 2>"]]

Function: When program execution reaches the **InputFunc** command, the user is prompted to input the contents of the user-defined function.

Example: InputFunc v(v0, t), "To define function v0(m/s), t(sec)", "define function"

Description: See **Input**.

**InputStr** I/O - Input

Syntax: InputStr□<variable name>[, "<string 1>"[, "<string 2>"]]

Function: When program execution reaches the **InputStr** command, the user is prompted for input of a string, which is assigned to a variable.

Description: See **Input**.

**Intersection** Misc - Graph&Table(1)

Function: Used as a **SetInequalityPlot** command argument to specify an option. See **SetInequalityPlot**.

**InvBinomialCD** Keyboard

Syntax: InvBinomialCD□*prob* value, Numtrial value, *pos* value

Function: See "Inverse Binomial Cumulative Distribution" (page 152).

**InvChiCD** Keyboard

Syntax: InvChiCD□*prob* value, *df* value

Function: See "Inverse  $\chi^2$  Cumulative Distribution" (page 152).

**Inverse** I/O - Sketch

Syntax: Inverse□<*y* or *x* graph number>[, <color command>]

Function: Graphs the inverse of a function.

Description: Graph number range: 1 to 100

**InvFCD** Keyboard

Syntax: InvFCD□*prob* value, *n:df* value, *d:df* value

Function: See "Inverse *F* Cumulative Distribution" (page 152).

**InvGeoCD** Keyboard

Syntax: InvGeoCD□*prob* value, *pos* value

Function: See "Inverse Geometric Cumulative Distribution" (page 153).

**InvHypergeoCD** Keyboard

Syntax: InvHypergeoCD□*prob* value, *n* value, *M* value, *N* value

Function: See "Inverse Hypergeometric Cumulative Distribution" (page 153).

**InvNormCD** Keyboard

Syntax: {InvNormCD□ ; InvNorm□}"Tail setting", Area value,  $\sigma$  value,  $\mu$  value

Function: See "Inverse Normal Cumulative Distribution" (page 151).

**InvPoissonCD** Keyboard

Syntax: InvPoissonCD□*prob* value,  $\lambda$  value

Function: See "Inverse Poisson Cumulative Distribution" (page 153).

**InvTCD** Keyboard

Syntax: InvTCD□*prob* value, *df* value

Function: See "Inverse Student's *t* Cumulative Distribution" (page 152).

**L****Lbl** Ctrl - Jump

See **Goto~Lbl**.

**Ldot** Misc - Statistics(2)

Function: Used as a **StatGraph** command argument to specify an option. See **StatGraph**.

**Line** I/O - Sketch

Syntax: Line□<start point *x*-coordinate>, <start point *y*-coordinate>, <end point *x*-coordinate>, <end point *y*-coordinate>[, <color command>]

Function: Draws a line between two specified coordinates.

**Tip:** The line is not drawn if a start point coordinate or end point coordinate is outside of the current Graph window.

**LinearReg (LinearR)** Misc - Statistics(1) - Regression

Syntax: LinearReg□*xList*, *yList*[, {FreqList (or 1)}] [, {<yn>}[, {On ; Off}]]]

Function: Performs  $y = a \cdot x + b$  regression.

Description: See **SinReg**.

**LineType** Misc - Setup(2)

Function: Used as a **SetGrid** command argument to specify an option. See **SetGrid**.

**LinRegTTest** Keyboard

Syntax: LinRegTTest□" $\beta$  &  $\rho$  condition", *XList*, *YList*[, {Freq ; 1}]

Function: See "Linear Regression *t* Test" (page 147).

**Local** **Misc - Variable**

Syntax: Local□<variable name>, <variable name> ...  
[,<color command>]

Function: Defines a local variable.

Description: The following are the merits of local variables.

- Since local variables are deleted automatically, use of local variables for temporary storage avoids unnecessary use of available memory.
- Since local variables do not affect general (user) variables, you can name local variables without worrying about whether the name you are using is already used by another variable.

**Locate** **I/O - Output**

Syntax 1: Locate□<x-coordinate>, <y-coordinate>, <expression>

Syntax 2: Locate□<x-coordinate>, <y-coordinate>, "<string>"

Function: This command displays the result of the specified expression or the specified text string at the specified coordinates on the display screen.

Description:

- The coordinates of the point at the upper left corner of the effective area of the Locate command are (1, 1), and coordinate values can be specified in the range of 1 to 580 for the *x*-coordinate and 1 to 580 for the *y*-coordinate. Note, however, that the actual dot count of the ClassPad screen is 320 × 528.
- An expression result is displayed as a single line.

**Lock** **Misc - Variable**

Syntax: Lock□<variable name>, <variable name> ...

Function: Locks variables.

**LockFolder** **Misc - Variable - Folder**

Syntax: LockFolder□<folder name>

Function: Locks the specified folder and all the files currently inside of it.

**LogisticReg (LogisticR)** **Misc - Statistics(1) - Regression**

Syntax: LogisticReg□*x*List, *y*List[,<yn>][, {On ; Off}]]

Function: Performs  $y = c/(1 + a \cdot e^{-bx})$  regression.

Description: See **SinReg**.

**LogP** **Misc - Graph&Table(1)**

Function: Used as a **ViewWindow** command argument to specify an option. See **ViewWindow**.

**LogReg (LogR)** **Misc - Statistics(1) - Regression**

Syntax: LogReg□*x*List, *y*List[,<FreqList (or 1)>][, {<yn>}[, {On ; Off}]]

Function: Performs  $y = a + b \cdot \ln(x)$  regression.

Description: See **SinReg**.

**LpWhile** **Ctrl - Do**

See **Do~LpWhile**.

**M****MedBox** **Misc - Statistics(1) - Graph**

Function: Used as a **StatGraph** command argument to specify an option. See **StatGraph**.

**MedMedLine (MedMed)** **Misc - Statistics(1) - Regression**

Syntax: MedMedLine□*x*List, *y*List[,<FreqList (or 1)>][, {<yn>}[, {On ; Off}]]

Function: Performs  $y = a \cdot x + b$  Med-Med calculation.

Description: See **SinReg**.

**Message** **I/O - Output**

Syntax: Message□"<string 1>" [, "<string 2>"]

Function: This command pauses program execution and displays a dialog box containing the text specified by "<string 1>".



The text is positioned flush top left. The text specified for "<string 2>" is used as the dialog box title.

Description:

- Text strings enclosed within quotation marks (" ") or variable names can be specified for "<string 1>" and "<string 2>".
- Tapping [OK] closes the dialog box and resumes program execution.
- Tapping [Cancel] terminates program execution.

**ModBox** **Misc - Statistics(1) - Graph**

Function: Used as a **StatGraph** command argument to specify an option. See **StatGraph**.

**MoveVar** **Misc - Variable**

Syntax: MoveVar□<variable name>, <current folder name>, <destination folder name>

Function: Moves a variable to the specified folder.

**MultiSortA** **Keyboard**

Syntax 1: MultiSortA□<list name>

Syntax 2: MultiSortA□<base list name>, <subordinate list name>, <subordinate list name>, ...

Function: Sorts a statistical list in ascending order.

Description:

- Syntax 1 performs a simple list sort.
- Syntax 2 sorts multiple lists on the base list. Up to five subordinate lists can be specified.

**MultiSortD** Keyboard

Syntax 1: MultiSortD□<list name>

Syntax 2: MultiSortD□<base list name>, <subordinate list name>, <subordinate list name>, ...

Function: Sorts a statistical list in descending order.

Description: See **MultiSortA**.

**N****NDist** Misc - Statistics(1) - Graph

Function: Used as a **StatGraph** command argument to specify an option. See **StatGraph**.

**NewFolder** Misc - Variable - Folder

Syntax: NewFolder□<folder name>

Function: Creates a new folder.

**Next** Ctrl - For

See **For~To~(Step~)Next**.

**NormCD** Keyboard

Syntax: NormCD□Lower value, Upper value,  $\sigma$  value,  $\mu$  value

Function: See “Normal Cumulative Distribution” (page 151).

**NormPD** Keyboard

Syntax: NormPD□ $x$  value,  $\sigma$  value,  $\mu$  value

Function: See “Normal Probability Density” (page 151).

**NormalLine** I/O - Sketch

Syntax: NormalLine□<graph number>, < $x$ -coordinate>[,<color command>]

Function: Draws a normal line.

Description: Draws a line normal to the graph at the specified  $x$ -value.

**not** Ctrl - Logic

See “Bitwise Operations” (page 60).

**NPPlot** Misc - Statistics(1) - Graph

Function: Used as a **StatGraph** command argument to specify an option. See **StatGraph**.

**NumToChr** Misc - String(1)

Syntax: NumToChr□ $n$ ,<storage variable name>

Function: Converts numeric value  $n$  to the corresponding text character(s) in accordance with the character code table, and assigns the character(s) as a string to the specified variable. For information about character codes, see “Character Code Table” on page 295.

**NumToStr** Misc - String(1)

Syntax: NumToStr□<value>, {"Fix <integer from 0 to 9>" ; "Sci <integer from 0 to 9>"}, <storage variable name>

Function: Converts a numeric value to a string of the specified format, and assigns the resulting string to the specified variable.

**O****Off** Misc - Setup(1)

Function: Used as the argument of Setup type commands to turn off the setting.

**On** Misc - Setup(1)

Function: Used as the argument of Setup type commands to turn on the setting.

**OnePropZTest** Keyboard

Syntax: OnePropZTest□"Prop condition",  $p_0$  value,  $x$  value,  $n$  value

Function: See “1-Proportion  $Z$  Test” (page 147).

**OnePropZInt** Keyboard

Syntax: OnePropZInt□C-Level value,  $x$  value,  $n$  value

Function: See “1-Proportion  $Z$  Interval” (page 150).

**OneSampleTInt** Keyboard

Syntax 1: OneSampleTInt□C-Level value, List [, {Freq ; 1}]

Syntax 2: OneSampleTInt□C-Level value,  $\bar{x}$  value,  $s_x$  value,  $n$  value

Function: See “1-Sample  $t$  Interval” (page 150).

**OneSampleTTest** Keyboard

Syntax 1: OneSampleTTest□" $\mu$  condition",  $\mu_0$  value, List[, {Freq ; 1}]

Syntax 2: OneSampleTTest□" $\mu$  condition",  $\mu_0$  value,  $\bar{x}$  value,  $s_x$  value,  $n$  value

Function: See “1-Sample  $t$  Test” (page 147).

**OneSampleZInt** Keyboard

Syntax 1: OneSampleZInt□C-Level value,  $\sigma$  value, List[, {Freq ; 1}]

Syntax 2: OneSampleZInt□C-Level value,  $\sigma$  value,  $\bar{x}$  value,  $n$  value

Function: See “1-Sample  $Z$  Interval ” (page 150).

**OneSampleZTest** Keyboard

Syntax 1: OneSampleZTest□" $\mu$  condition",  $\mu_0$  value,  $\sigma$  value, List[, {Freq ; 1}]

Syntax 2: OneSampleZTest□" $\mu$  condition",  $\mu_0$  value,  $\sigma$  value,  $\bar{x}$  value,  $n$  value

Function: See “1-Sample  $Z$  Test” (page 146).

**OneVariable** Keyboard

Syntax: OneVariable  $\square$  xList [,FreqList (or 1)]

Function: Single variable statistics calculation

Description:

xList: Name of list for storing  $x$ -axis data

FreqList: Name of list for storing frequency of "xList" data

- "FreqList" can be omitted. Doing so sets "1" for "FreqList".

**OneWayANOVA** Keyboard

Syntax: OneWayANOVA  $\square$  FactorList(A),  
DependentList

Function: See "One-Way ANOVA" (page 148).

**OpenComPort38k** I/O - Communication

Syntax: OpenComPort38k

Function: Opens the 3-pin COM port.

**or** Ctrl - Logic

See "Bitwise Operations" (page 60).

**P****Pause** Ctrl - Control

Syntax: Pause

Function: Pauses program execution and displays a pause indicator on the right side of the status bar.

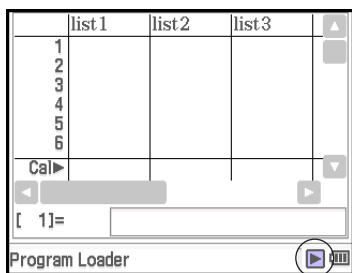

Description:

- You can perform manual operations on the ClassPad display screen while program execution is paused by the **Pause** command.
- Program execution remains paused until you tap the  button on the status bar, or until six minutes pass (after which program execution resumes automatically).

**PeriodsAnnual** Keyboard

Syntax: PeriodsAnnual

Function: Specifies annual for the bond calculation payment periods

**PeriodsSemi** Keyboard

Syntax: PeriodsSemi

Function: Specifies semiannual for the bond calculation payment periods

**Plot** I/O - Sketch - Plot

Syntax: Plot  $\square$  <x-coordinate>, <y-coordinate>[,<color command>]

Function: Displays a pointer at the location specified by the coordinates and plots a point there.

**PlotChg** I/O - Sketch - Plot

Syntax: PlotChg  $\square$  <x-coordinate>, <y-coordinate>[,<color command>]

Function: If there is a plot at the specified coordinates, the plot within a 3x3-dot area centered on those coordinates are deleted. If there is no plot at the specified coordinates, a point is plotted within a 3x3-dot area centered on those coordinates.

**PlotOff** I/O - Sketch - Plot

Syntax: PlotOff  $\square$  <x-coordinate>, <y-coordinate>

Function: Deletes the plot within a 3x3-dot area centered on the specified coordinates.

**PlotOn** I/O - Sketch - Plot

Syntax: PlotOn  $\square$  <x-coordinate>, <y-coordinate>[,<color command>]

Function: Plots a point within a 3x3-dot area centered on the specified coordinates.

**plotTest()** I/O - Sketch - Plot

Syntax: plotTest(<x-coordinate>, <y-coordinate>)

Function: If a dot is present at the specified pixel, returns a value that corresponds to the color of the dot (Black: 1, Blue: 2, Red: 3, Magenta: 4, Green: 5, Cyan: 6, Yellow: 7). Returns 0 if no dot is present at the specified pixel.

Description: Only dots within the screen are valid.

**PmtBgn** Keyboard

Syntax: PmtBgn

Function: Specifies beginning of period for the financial calculation payment date.

**PmtEnd** Keyboard

Syntax: PmtEnd

Function: Specifies end of period for the financial calculation payment date.

**PoissonCD** Keyboard

Syntax: PoissonCD  $\square$  Lower value, Upper value,  $\lambda$  value

Function: See "Poisson Cumulative Distribution" (page 153).

**PoissonPD** Keyboard

Syntax: PoissonPD  $\square$   $x$  value,  $\lambda$  value

Function: See "Poisson Distribution Probability" (page 152).



**PowerReg (PowerR)****Misc - Statistics(1) - Regression**

Syntax: PowerReg□*x*List, *y*List,[FreqList (or 1)]  
[, [*yn*] [, {On ; Off}]]

Function: Performs  $y = a \cdot x^b$  regression.

Description: See **SinReg**.

**Print** I/O - Output

Syntax 1: Print□<expression>[, <color command>]

Syntax 2: Print□"<string>"

Function: Displays the result of the specified expression or the specified text string.

Description: An expression result is displayed as a single line. When the result is a long expression, fraction, or string, it may not fit on the display. In such a case, use the **PrintNatural** command instead.

**PrintNatural** I/O - Output

Syntax: PrintNatural□<expression>[, "<string>"]

Function: Pauses program execution and displays the result of the specified expression in natural format.

Description:

- A text string enclosed within quotation marks (" ") or a variable name can be specified for "<string>".
- Tapping [OK] closes the dialog box and resumes program execution. Tapping [Cancel] terminates program execution.

**PTBrokenThck** Misc - Graph&Table(1) - Plot Type

Syntax: PTBrokenThck□<graph number>

Function: Specifies "Broken Thick" as the graph line type.

Description: Graph number range: 1 to 100

**PTDot** Misc - Graph&Table(1) - Plot Type

Syntax: PTDot□<graph number>

Function: Specifies "Dot Plot" as the graph line type.

Description: Graph number range: 1 to 100

**PTNormal** Misc - Graph&Table(1) - Plot Type

Syntax: PTNormal□<graph number>

Function: Specifies "Normal" as the graph line type.

Description: Graph number range: 1 to 100

**PTThick** Misc - Graph&Table(1) - Plot Type

Syntax: PTThick□<graph number>

Function: Specifies "Thick" as the graph line type.

Description: Graph number range: 1 to 100

**PTThin** Misc - Graph&Table(1) - Plot Type

Syntax: PTThin□<graph number>

Function: Specifies "Thin" as the graph line type.

Description: Graph number range: 1 to 100

**PxlChg** I/O - Sketch - Pixel

Syntax: PxlChg□<*x*-dot>, <*y*-dot>[, <color command>]

Function: Toggles display of the specified pixel on or off.

**PxlOff** I/O - Sketch - Pixel

Syntax: PxlOff□<*x*-dot>, <*y*-dot>

Function: Turns off display of the specified pixel.

**PxlOn** I/O - Sketch - Pixel

Syntax: PxlOn□<*x*-dot>, <*y*-dot>[, <color command>]

Function: Turns on display of the specified pixel.

**pxlTest(** I/O - Sketch - Pixel

Syntax: pxlTest (<*x*-dot>, <*y*-dot>)

Function: If a dot is present at the specified pixel, returns a value that corresponds to the color of the dot (Black: 1, Blue: 2, Red: 3, Magenta: 4, Green: 5, Cyan: 6, Yellow: 7). Returns 0 if no dot is present at the specified pixel.

**Q****QuadReg (QuadR)****Misc - Statistics(1) - Regression**

Syntax: QuadReg□*x*List, *y*List,[FreqList (or 1)]  
[, [*yn*] [, {On ; Off}]]

Function: Performs  $y = a \cdot x^2 + b \cdot x + c$  regression.

Description: See **SinReg**.

**QuartReg (QuartR)****Misc - Statistics(1) - Regression**

Syntax: QuartReg□*x*List, *y*List,[FreqList (or 1)]  
[, [*yn*] [, {On ; Off}]]

Function: Performs  $y = a \cdot x^4 + b \cdot x^3 + c \cdot x^2 + d \cdot x + e$  regression.

Description: See **SinReg**.

**R****RclGMem** Misc - Graph&Table(2)

Syntax: RclGMem□{<variable name> ; <folder name>  
file name>}

Function: Recalls GMem data (graph expression and related information), which was previously saved under the specified name.

Description: A folder path can be specified only up to one level.

**RclPict** Misc - Graph&Table(2)

Syntax: RclPict□<picture name>

Function: Recalls a Pict image, which was previously saved under the specified name.

**RclVWin** **Misc - Graph&Table(2)**

Syntax: RclVWin□{<variable name> ; <folder name\ file name>}

Function: Recalls View Window values, which were previously saved under the specified name.

Description: A folder path can be specified only up to one level.

**Receive38k** **I/O - Communication**

Syntax: Receive38k□<variable name>

Function: Receives Data Logger data.

Description:

- The **OpenComPort38k** command must be executed before this command is executed.
- The **CloseComPort38k** command must be executed after this command is executed.
- For details about using this command, see the user documentation that comes with the EA-200.
- Note that you need to replace all instances of the **Receive** command in the examples provided in the EA-200 user documentation with the command **Receive38k**. You should also adjust the other commands in the EA-200 examples so they conform to the ClassPad command syntax and usage as described in this manual.

**Rename** **Misc - Variable**

Syntax: Rename□<current variable name>, <new variable name>

Function: Renames a variable.

**Return** **Ctrl - Control**

Syntax: Return□{<variable>}

Function 1 (Main Program): Terminates program execution.

Function 2 (Subroutine Program): Returns from a subroutine.

**Tip**

- The **Return** command can be executed during an **If**, **For**, **Do**, **While**, or **Switch** process.
- Appending a <variable> to the **Return** command in the Main application and executing the command will cause the variable to be displayed when the program is complete.

**S****Scatter** **Misc - Statistics(1) - Graph**

Function: Used as a **StatGraph** command argument to specify an option. See **StatGraph**.

**Send38k** **I/O - Communication**

Syntax: Send38k□<variable name>

Function: Sends Data Logger data.

Description:

- The **OpenComPort38k** command must be executed before this command is executed.
- The **CloseComPort38k** command must be executed after this command is executed.
- For details about using this command, see the user documentation that comes with the EA-200.
- Note that you need to replace all instances of the **Send** command in the examples provided in the EA-200 user documentation with the command **Send38k**. You should also adjust the other commands in the EA-200 examples so they conform to the ClassPad command syntax and usage as described in this manual.
- <variable name> must be a variable that contains a real number or a list. Anything else results in an error.

**SendVar38k** **I/O - Communication**

Syntax: SendVar38k□<variable name>

Function: Sends variable names and variable contents.

Description:

- The **OpenComPort38k** command must be executed before this command is executed.
- The **CloseComPort38k** command must be executed after this command is executed.

**SeqSelOff** **Misc - Sequence**

Syntax: SeqSelOff□{ $a_{n+1}$  ;  $a_{n+2}$  ;  $b_{n+1}$  ;  $b_{n+2}$  ;  $c_{n+1}$  ;  $c_{n+2}$  ;  $a_nE$  ;  $b_nE$  ;  $c_nE$ }

Function: Deselects the specified sequence expression. Specifying " $a_nE$ ", " $b_nE$ ", or " $c_nE$ " as the argument activates [Explicit]. Specifying any other argument activates [Recursive].

**SeqSelOn** **Misc - Sequence**

Syntax: SeqSelOn□{ $a_{n+1}$  ;  $a_{n+2}$  ;  $b_{n+1}$  ;  $b_{n+2}$  ;  $c_{n+1}$  ;  $c_{n+2}$  ;  $a_nE$  ;  $b_nE$  ;  $c_nE$ }

Function: Selects the specified sequence expression. Specifying " $a_nE$ ", " $b_nE$ ", or " $c_nE$ " as the argument activates [Explicit]. Specifying any other argument activates [Recursive].

**SeqType** **Misc - Sequence**

Syntax: SeqType□{" $n$ " ; " $a_{n+1}a_0$ " ; " $a_{n+1}a_1$ " ; " $a_{n+2}a_0$ " ; " $a_{n+2}a_1$ "}

Function: Specifies the recursion type.

Description: Specifying " $n$ " as the argument activates [Explicit]. Specifying any other argument activates [Recursive].

**SetAxes** **Misc - Setup(2)**

Syntax: SetAxes□{On ; Off ; Number}

Function: Specifies the axis display mode as show Graph window axes only (On), hide axes and scale (Off), or show axes and scale (Number).

**SetCellWidth** **Misc - Setup(4)**

Syntax: SetCellWidth□{2 ; 3 ; 4}

Function: Specifies the number of rows displayed on the Stat Editor and data table windows.

**SetComplex** **Misc - Setup(1)**

Syntax: SetComplex

Function: Specifies the Complex mode (to perform complex number calculations).

**SetCoord** **Misc - Setup(2)**

Syntax: SetCoord□{On ; Off}

Function: Turns display of Graph window pointer coordinates on or off.

**SetDecimal** **Misc - Setup(1)**

Syntax: SetDecimal

Function: Specifies the Decimal mode (displays results in decimal format).

**SetDegree** **Misc - Setup(1)**

Syntax: SetDegree

Function: Specifies “Degree” for the angle unit.

**SetDeriv** **Misc - Setup(3)**

Syntax: SetDeriv□{On ; Off}

Function: Turns display of Graph window pointer coordinates and ordered pair table derivative on or off.

**SetDispGCon** **Misc - Setup(2)**

Syntax: SetDispGCon□{On ; Off}

Function: Turns display of graph controller arrows during graphing on or off.

**SetDrawCon** **Misc - Setup(2)**

Syntax: SetDrawCon

Function: Specifies graphing by connecting plotting points with lines.

**SetDrawPlt** **Misc - Setup(2)**

Syntax: SetDrawPlt

Function: Specifies graphing by plotting points only.

**SetFix** **Misc - Setup(2)**

Syntax: SetFix□<integer from 0 to 9>

Function: Specifies the fixed number of decimal places.

**SetFolder** **Misc - Variable - Folder**

Syntax: SetFolder□<folder name> [, <storage variable name>]

Function:

- Makes the specified folder the current folder. Including a variable name at the end of this command assigns the name of the previous current folder to the variable as a text string.
- If the specified folder does not exist, this command creates a new folder with the specified name, and makes it the current folder.

**SetFunc** **Misc - Setup(3)**

Syntax: SetFunc□{On ; Off}

Function: Turns display of graph function name and function on or off.

**SetGraphColor** **Misc - Setup(4)**

Syntax: SetGraphColor□<graph number>, <color command>

Function: Specifies the graph color.

Description: The graph number range is 1 to 100.

**SetGrad** **Misc - Setup(1)**

Syntax: SetGrad

Function: Specifies “Grad” for the angle unit.

**SetGrid** **Misc - Setup(2)**

Syntax: SetGrid□{On ; Off ; LineType}

Function: Specifies the Graph window grid type display mode as show as dots (**On**), hide grid (**Off**), and show as grid lines (**LineType**).

**SetInequalityPlot** **Misc - Setup(4)**

Syntax: SetInequalityPlot□{Intersection ; Union}

Function: When graphing multiple inequalities, fills areas where all inequality conditions are satisfied (**Intersection**) or fills areas where each inequality condition is satisfied (**Union**).

**SetLabel** **Misc - Setup(2)**

Syntax: SetLabel□{On ; Off}

Function: Turns display of Graph window axis labels on or off.

**SetLeadCursor** **Misc - Setup(3)**

Syntax: SetLeadCursor□{On ; Off}

Function: Turns display of the leading cursor during graphing on or off.

**SetNormal** **Misc - Setup(2)**

Syntax: SetNormal□{1 ; 2}

Function: Specifies Normal 1 or Normal 2 as the auto exponential display setting for values.

**SetRadian** **Misc - Setup(1)**

Syntax: SetRadian

Function: Specifies “Radian” for the angle unit.

**SetReal** Misc - Setup(1)

Syntax: SetReal

Function: Specifies the Real mode (to perform real number calculations).

**SetSci** Misc - Setup(2)

Syntax: SetSci  $\square$  {integer from 0 to 9}

Function: Specifies the fixed number of significant digits.

**SetSequence** Misc - Setup(4)

Syntax: SetSequence  $\square$  {On ; Off ; StepDisp}

Function: Turns display of expressions created after graphing on or off or specifies "step display" (**StepDisp**).

Description: When **StepDisp** is selected, the expression does not appear until you press **[EXE]**.

**SetSimulGraph** Misc - Setup(2)

Syntax: SetSimulGraph  $\square$  {On ; Off}

Function: Turns simultaneous drawing of multiple graphs on or off.

**SetSketchColor** Misc - Setup(4)

Syntax: SetSketchColor [, <color command>]

Function: Specifies the color of an object drawn with the Sketch function.

**SetSmryTable** Misc - Setup(3)

Syntax: SetSmryTable  $\square$  {<list name> ; VWin}

Function: Specifies whether summary table generation is View Window dependent or List dependent. Using **VWin** specifies View Window dependent.

**SetSmryTableQD** Misc - Setup(3)

Syntax: SetSmryTableQD  $\square$  {On ; Off}

Function: Specifies whether the second derivative will appear in summary tables.

**SetStandard** Misc - Setup(1)

Syntax: SetStandard

Function: Specifies the Standard mode (to leave calculation results as expressions).

**SetStatWinAuto** Misc - Setup(4)

Syntax: SetStatWinAuto  $\square$  {On ; Off}

Function: Turns automatic setup of Statistics application View Window on or off.

**SetTVariable** Misc - Setup(3)

Syntax: SetTVariable  $\square$  {<list name> ; TableInput}

Function: Specifies the variable reference location for table generation.

Description: Use **TableInput** to specify a range and generate a table.

**Set $\Sigma$ disp** Misc - Setup(4)

Syntax: Set $\Sigma$ disp  $\square$  {On ; Off}

Function: Turns display of subtotals for tables on or off.

**SheetActive** Misc - Graph&Table(1) - Sheet

Syntax: SheetActive  $\square$  {<sheet number> ; "<sheet name>"}

Function: Selects the sheet that contains the expression to be graphed.

Description: Even after a sheet is renamed, it can still be specified using its previous sheet number.

**SheetName** Misc - Graph&Table(1) - Sheet

Syntax: SheetName  $\square$  "<sheet name string>", <sheet number>

Function: Assigns a name to a sheet

Description:

- A sheet name can be up to eight characters long.
- Sheet number range: 1 to 5

**SinReg (SinR)** Misc - Statistics(1) - Regression

Syntax: SinReg  $\square$  xList, yList[, [<yn>][, {On ; Off}]]

Function: Performs  $y = a \cdot \sin(b \cdot x + c) + d$  regression.

Description:

xList: Name of list for storing  $x$ -axis data

yList: Name of list for storing  $y$ -axis data

- "yn" is the Graph Editor name (y1, y2, ...) that is the copy destination of the regression expression. Copy is not performed when "yn" is skipped.
- "On/Off" turns residual calculation on or off. Residual calculation is turned off when this setting is skipped.

**Skip** Ctrl - Control

Syntax: Skip

Function: Causes execution to jump to the statement at the beginning of a loop.

Description:

- **Skip** causes execution to jump to the statement at the beginning of a loop.
- **Skip** can be used inside of a **For**, **Do**, or **While** process.

**SmryTselOn** Misc - Graph&Table(1)

Syntax: SmryTselOn  $\square$  <expression number>

Function: Deselects all currently selected expressions and then selects only the specified summary table expression.

**Square** Misc - Statistics(2)

Function: Used as a **StatGraph** command argument to specify an option. See **StatGraph**.

**StatGraph** **Misc - Statistics(1)**

Syntax 1: StatGraph□<StatGraph number 1 to 9>, {On ; Off}, Graph Type 1, xList, yList, FreqList (or 1), Plot Type

Syntax 2: StatGraph□<StatGraph number 1 to 9>, {On ; Off}, Graph Type 2, xList, yList, FreqList (or 1)

Syntax 3: StatGraph□<StatGraph number 1 to 9>, {On ; Off}, Graph Type 3, xList, yList

Syntax 4: StatGraph□<StatGraph number 1 to 9>, {On ; Off}, Graph Type 4, xList, FreqList (or 1)

Syntax 5: StatGraph□<StatGraph number 1 to 9>, {On ; Off}, Graph Type 5, xList, Plot Type

Function: Configures statistical graph settings.

Description:

xList: Name of list for storing *x*-axis data

yList: Name of list for storing *y*-axis data

FreqList: Name of list for storing frequency of “xList” and “yList” data

Graph Type 1: **Scatter**, **xyLine**

Graph Type 2: **LinearR**, **MedMed**, **QuadR**, **CubicR**, **QuartR**, **LogR**, **ExpR**, **abExpR**, **PowerR**

Graph Type 3: **SinR**, **LogisticR**

Graph Type 4: **Histogram**, **MedBox**, **ModBox**, **NDist**, **Broken**

Graph Type 5: **NPPlot**

Plot Type: **Square**, **Cross**, **Dot**, **Ldot**

**StatGraphSel** **Misc - Statistics(1)**

Syntax: StatGraphSel□{On ; Off} {"Reg," ; "Graph"}

Function: Turns statistical graphing on or off.

Description:

- “Reg” selects Previous Reg.
- “Graph” selects Graph Function.
- Skipping “Reg” and “Graph” turns StatGraph, Previous Reg, and Graph Function on or off.

**Step** **Ctrl - For**

See **For~To~(Step~)Next**.

**StepDisp** **Misc - Setup(4)**

Function: Used as a **SetSequence** command argument to specify an option. See **SetSequence**.

**StoGMem** **Misc - Graph&Table(2)**

Syntax: StoGMem□{<variable name> ; <folder name\ file name>}

Function: Assigns a name to GMem data (graph expression and related information) and stores it.

Description: A folder path can be specified only up to one level.

**Stop** **Ctrl - Control**

Syntax: Stop

Function: Terminates program execution.

Description: This command terminates all program execution, including that of the main program when a subroutine program is running.

**StoPict** **Misc - Graph&Table(2)**

Syntax: StoPict□<picture name>

Function: Assigns a name to a Pict image and stores it.

**StoVWin** **Misc - Graph&Table(2)**

Syntax: StoVWin□{<variable name> ; <folder name\ file name>}

Function: Assigns a name to View Window values and stores them.

Description: A folder path can be specified only up to one level.

**StrCmp** **Misc - String(1)**

Syntax: StrCmp□"<string 1>", "<string 2>", <storage variable name>

Function: Compares "<string 1>" and "<string 2>" (character code comparison) and assigns the resulting value to the specified variable.

Description:

- Returns 0 when "<string 1>" = "<string 2>".
- Returns 1 when "<string 1>" > "<string 2>".
- Returns -1 when "<string 1>" < "<string 2>".

**StrInv** **Misc - String(1)**

Syntax: StrInv□"<string>", <storage variable name>

Function: Inverts the sequence of a string and assigns the resulting string to a variable.

**StrJoin** **Misc - String(1)**

Syntax: StrJoin□"<string 1>", "<string 2>", <storage variable name>

Function: Joins "<string 1>" and "<string 2>" and then assigns the resulting string to the specified variable.

**StrLeft** **Misc - String(1)**

Syntax: StrLeft□"<string>", *n*, <storage variable name>

Function: Copies a string up to the *n*th character from the left, and assigns the resulting string to the specified variable.

**StrLen** **Misc - String(1)**

Syntax: StrLen□"<string>", <storage variable name>

Function: Determines the length of a string (the number of its characters) and assigns the resulting value to the specified variable.

**StrLwr** Misc - String(2)

Syntax: StrLwr□"<string>", <storage variable name>

Function: Converts all the characters of a string to lower case and assigns the resulting string to the specified variable.

**StrMid** Misc - String(2)

Syntax: StrMid□"<string>", *n*, <storage variable name> [, <number of characters>]

Function: Copies a specific number of characters of a string, starting from the *n*th character, and assigns the resulting string to the specified variable.

Description: Omitting the number of characters causes the string to be copied up to the end.

**StrRight** Misc - String(2)

Syntax: StrRight□"<string>", *n*, <storage variable name>

Function: Copies a string up to the *n*th character from the right, and assigns the resulting string to the specified variable.

**StrRotate** Misc - String(2)

Syntax: StrRotate□"<string>", <storage variable name> [, *n*]

Function: Rotates the left side part and right side part of a string at the *n*th character, and assigns the resulting string to the specified variable.

Description: Rotation is to the left when "*n*" is positive, and to the right when "*n*" is negative. Omitting "*n*" uses a default value of +1.

**StrShift** Misc - String(2)

Syntax: StrShift□"<string>", <storage variable name> [, *n*]

Function: Shifts a string left or right *n* characters, and assigns the resulting string to the specified variable.

Description: Shift is to the left when "*n*" is positive, and to the right when "*n*" is negative. Omitting "*n*" uses a default value of +1.

**StrSrc** Misc - String(2)

Syntax: StrSrc□"<string 1>", "<string 2>", <storage variable name> [, <search start location>]

Function: Searches "<string 1>" starting from the specified point (*n*th character from beginning of string) to determine if it contains the data specified by "<string 2>". If the data is found, this command returns the location of the first character of "<string 2>", starting from the beginning of "<string 1>".

Description: Omitting the start point causes the search to start from the beginning of "<string 1>".

**strToExp** Misc - String(2)

Syntax: strToExp("<string>")

Function: Converts a string to an expression, and executes the expression.

**StrUpr** Misc - String(2)

Syntax: StrUpr□"<string>", <storage variable name>

Function: Converts all the characters of a string to upper case and assigns the resulting string to the specified variable.

**Switch~Case~Default~SwitchEnd** Ctrl - Switch

Syntax:

```
Switch□<expression 1> : Case□<expression 2> :
[<statement>] ... : Break : Case□<expression 3> ... :
[<statement>] ... : Break : ... : Case□<expression n> :
[<statement>] ... : Break : Default : [<statement>] ... :
SwitchEnd
```

- <expression 1> through <expression n> should be expressions that produce real numbers.

Function: Executes one of a series of processes based on the value of <expression>.

Description:

- This command executes the statement following the **Case** expression that matches the **Switch** expression.
- If there is no matching **Case** expression, the statement following **Default** is executed. If there is no **Default** specified, a non-match jumps to the statement following **SwitchEnd**.
- You can use a multi-statement command (:) in place of the carriage return to separate statements.
- **Switch~SwitchEnd** can be exited using the **Break** command, **Return** command, or **Goto** command.

**SwitchEnd** Ctrl - Switch

See **Switch~Case~Default~SwitchEnd**.

**T****TableInput** Misc - Setup(3)

Function: Used as a **SetTVariable** command argument to specify an option. See **SetTVariable**.

**TangentLine** I/O - Sketch

Syntax: TangentLine□<graph number>, <*x*-coordinate> [, <color command>]

Function: Draws a line tangent to the graph at the specified *x*-value.

**TCD** Keyboard

Syntax: TCD□Lower value, Upper value, *df* value

Function: See "Student's *t* Cumulative Distribution" (page 151).

**Text** I/O - Sketch

Syntax: Text□<horizontal pixel value>, <vertical pixel value>, {<numeric value> ; "<string>" ; <variable>} [, <color command>]

Function: Displays the specified text on the Graph window.

**Then** Ctrl - If

See **If~Then~Else~IfEnd**.

**To** **Ctrl - For**

See **For~To~(Step~)Next**.

**TPD** Keyboard

Syntax: TPD  $\square$   $x$  value,  $df$  value

Function: See “Student’s  $t$  Probability Density” (page 151).

**TwoPropZInt** Keyboard

Syntax: TwoPropZInt  $\square$  C-Level value,  $x_1$  value,  $n_1$  value,  $x_2$  value,  $n_2$  value

Function: See “2-Proportion Z Interval” (page 150).

**TwoPropZTest** Keyboard

Syntax: TwoPropZTest  $\square$  “ $p_1$  condition”,  $x_1$  value,  $n_1$  value,  $x_2$  value,  $n_2$  value

Function: See “2-Proportion Z Test” (page 147).

**TwoSampleFTest** Keyboard

Syntax 1: TwoSampleFTest  $\square$  “ $\sigma_1$  condition”, List(1), List(2)[, {Freq(1) ; 1}, {Freq(2) ; 1}]

Syntax 2: TwoSampleFTest  $\square$  “ $\sigma_1$  condition”,  $s_{x_1}$  value,  $n_1$  value,  $s_{x_2}$  value,  $n_2$  value

Function: See “2-Sample  $F$  Test” (page 148).

**TwoSampleTInt** Keyboard

Syntax 1: TwoSampleTInt  $\square$  C-Level value, List(1), List(2)[, {Freq(1) ; 1}, {Freq(2) ; 1}, {On ; Off}]

Syntax 2: TwoSampleTInt  $\square$  C-Level value,  $\bar{x}_1$  value,  $s_{x_1}$  value,  $n_1$  value,  $\bar{x}_2$  value,  $s_{x_2}$  value,  $n_2$  value[, {On ; Off}]

- “On ; Off” turns Pooled condition on or off (turned off when this setting is skipped).

Function: See “2-Sample  $t$  Interval” (page 150).

**TwoSampleTTest** Keyboard

Syntax 1: TwoSampleTTest  $\square$  “ $\mu_1$  condition”, List(1), List(2)[, {Freq(1) ; 1}, {Freq(2) ; 1}, {On ; Off}]

Syntax 2: TwoSampleTTest  $\square$  “ $\mu_1$  condition”,  $\bar{x}_1$  value,  $s_{x_1}$  value,  $n_1$  value,  $\bar{x}_2$  value,  $s_{x_2}$  value,  $n_2$  value[, {On ; Off}]

- “On ; Off” turns Pooled condition on or off (turned off when this setting is skipped).

Function: See “2-Sample  $t$  Test” (page 147).

**TwoSampleZInt** Keyboard

Syntax 1: TwoSampleZInt  $\square$  C-Level value,  $\sigma_1$  value,  $\sigma_2$  value, List(1), List(2)[, {Freq(1) ; 1}, {Freq(2) ; 1}]

Syntax 2: TwoSampleZInt  $\square$  C-Level value,  $\sigma_1$  value,  $\sigma_2$  value,  $\bar{x}_1$  value,  $n_1$  value,  $\bar{x}_2$  value,  $n_2$  value

Function: See “2-Sample Z Interval” (page 150).

**TwoSampleZTest** Keyboard

Syntax 1: TwoSampleZTest  $\square$  “ $\mu_1$  condition”,  $\sigma_1$  value,  $\sigma_2$  value, List(1), List(2)[, {Freq(1) ; 1}, {Freq(2) ; 1}]

Syntax 2: TwoSampleZTest  $\square$  “ $\mu_1$  condition”,  $\sigma_1$  value,  $\sigma_2$  value,  $\bar{x}_1$  value,  $n_1$  value,  $\bar{x}_2$  value,  $n_2$  value

Function: See “2-Sample Z Test” (page 147).

**TwoVariable** Keyboard

Syntax: TwoVariable  $\square$   $x$ List,  $y$ List[, FreqList (or 1)]

Function: Performs paired-variable statistical calculation.

Description:

$x$ List: Name of list for storing  $x$ -axis data

$y$ List: Name of list for storing  $y$ -axis data

FreqList: Name of list for storing frequency of “ $x$ List” and “ $y$ List” data

- “FreqList” can be omitted. Doing so sets “1” for “FreqList”.

**TwoWayANOVA** Keyboard

Syntax: TwoWayANOVA  $\square$  FactorList(A), FactorList(B), DependentList

Function: See “Two-Way ANOVA” (page 149).

**U****Union** Misc - Graph&Table(1)

Function: Used as a **SetInequalityPlot** command argument to specify an option. See **SetInequalityPlot**.

**Unlock** Misc - Variable

Syntax: Unlock  $\square$  <variable name>, <variable name> ...

Function: Unlocks variables.

**UnlockFolder** Misc - Variable - Folder

Syntax: UnlockFolder  $\square$  <folder name>

Function: Unlocks the specified folder and all the files currently inside of it.

**V****Vertical** I/O - Sketch

Syntax: Vertical  $\square$  < $x$ -coordinate>[, <color command>]

Function: Draws a vertical line passing through the  $x$ -coordinate value.

**ViewWindow** Misc - Graph&Table(1)

Syntax 1: ViewWindow  $\square$  [LogP  $\square$  { $x$  ;  $y$  ;  $xy$ }, { $x$ min value}, { $x$ max value}, { $x$ scale value}, { $y$ min value}, { $y$ max value}, { $y$ scale value}, { $t\theta$ min value}, { $t\theta$ max value}, { $t\theta$ step value}]

Syntax 2: ViewWindow CallUndef

Syntax 3: ViewWindow

Function:

Syntax 1: Specifies View Window values.

Syntax 2: Makes all View Window values “Undefined”.

Syntax 3: Initializes View Window settings.

Description:

- **LogP** specifies logarithmic settings for the  $x$ -coordinate and  $y$ -coordinate.
- **LogP** and **CallUndef** are reserved words.
- Skipping values after  $x$ min causes values previously set for each item to be used.

**VWin** **Misc - Setup(3)**

Function: Used as a **SetSmryTable** command argument to specify an option. See **SetSmryTable**.

**W****Wait** **Ctrl - Control**

Syntax: Wait□[<expression>]

Function: Pauses program execution, and then restarts it after the number of seconds specified by the expression passes.

Description:

- If you do not specify any expression, program execution is paused until you tap the screen, or press a key.
- The maximum valid specification for <expression> is 360 seconds (six minutes). Specifying a value greater than 360 causes program execution to resume after 360 seconds, regardless of the specified value.
- The ClassPad's Auto Power Off function is disabled during a pause caused by the **Wait** command.
- If the Auto Power Off trigger time is reached during the pause, program execution resumes.

**While~WhileEnd** **Ctrl - While**

Syntax:

While□<expression> : [<statement>] ... : WhileEnd

- <expression> is a condition that evaluates to true or false.

Function: Repeats the specified statements as long as the condition is true.

Description:

- The statements between **While~WhileEnd** are repeated as long as the condition is true. When the condition becomes false, execution jumps to the next command after the **WhileEnd** command.
- Since the condition comes after **While**, the condition is evaluated before the loop is started.
- You can use a multi-statement command (:) in place of the carriage return to separate statements.
- Do not use the **Goto** command to exit a **While~WhileEnd** loop.

**WhileEnd** **Ctrl - While**

See **While~WhileEnd**.

**X****xor** **Ctrl - Logic**

See "Bitwise Operations" (page 60).

**xyLine** **Misc - Statistics(1) - Graph**

Function: Used as a **StatGraph** command argument to specify an option. See **StatGraph**.

**Z****ZAuto** **Misc - Graph&Table(1) - Zoom**

Syntax: ZAuto

Function: Performs Auto Zoom.

**ZFactor** **Misc - Graph&Table(1) - Zoom**

Syntax: ZFactor□<xfactor value>, <yfactor value>

Function: Specifies the Factor Zoom Factor value.



## 12-5 Including ClassPad Functions in Programs

This section provides actual examples that use graph drawing, statistical calculations and other ClassPad functions.

---

### Including Graphing Functions in a Program

**1201** To register  $y > \sin(x)$  as Graph Editor y1, and  $y < -x/12$  as Graph Editor y2 and then draw the inequality graph for the two expressions. On the resulting graph, only areas where the conditions of all of the graphed inequalities are satisfied will be filled in.

**1202** To graph  $(x - A)^2/3^2 + (y - B)^2/4^2$ . Make A and B the parameter variables and specify A=1 and B=2 when the program is run.

---

### Including Table & Graph Functions in a Program

**1203** To register  $y = 3x^2 - 2$  as Graph Editor y1 and then generate a number table based on the following:  $x$  start value: 0, end value: 6, step value: 1. Next, use the number table to display a connect type graph.

---

### Including Recursion Table and Recursion Graph Functions in a Program

**1204** To register the recursion formula  $a_{n+1} = -3 \times a_n^2 + 2 \times a_n$ ,  $a_0 = 0.01$  on the Sequence Editor window and then generate a number table based on the following:  $n$  start value: 1, end value: 6. Next, use the number table to display a connect type graph.

---

### Including Statistical Graphing and Calculation Functions in a Program

**1205** To input {0.5,1.2,2.4,4,5.2} for list1 and {-2.1,0.3,1.5,2,2.4} for list2, and then plot a scatter plot

**1206** To graph the logarithmic regression of the list1 and list2 data in Example **1205**

**1207** To graph the sinusoidal regression of the list1 and list2 data in Example **1205**

**1208** To plot the scatter plot of the list1 and list2 data in Example **1205**. Next, use the list1 and list2 data to calculate logarithmic regression and then display the calculation results and regression graph on the same screen.

**1209** To execute the One-Way ANOVA test program in Example **0706** (page 148)

**1210** To execute the Two-Way ANOVA test program in Example **0707** (page 149)

**1211** To specify  $\mu \neq 0$ ,  $\sigma = 3$  for  $n$  (sample size) = 48,  $\bar{x}$  (sample mean) = 24.5 data and perform a 1-Sample Z Test

---

### Including Financial Calculation Functions in a Program

**1212** To calculate the number of days from July 4, 1976 to another specified date. Calculate based on a 365-day year.

**1213** To execute the bond calculation program in Example **1108** (page 189)

# Chapter 13: Spreadsheet Application

The Spreadsheet application provides you with powerful, take-along-anywhere spreadsheet capabilities including graphing and statistical calculations on your ClassPad. A spreadsheet has 999 rows and 64 columns (A1 to BL999).

The Spreadsheet window shows a screen of cells and their contents. Each cell can contain a value, expression, text, or a formula. Formulas can contain a reference to a specific cell or a range of cells.

## Example Spreadsheet application windows



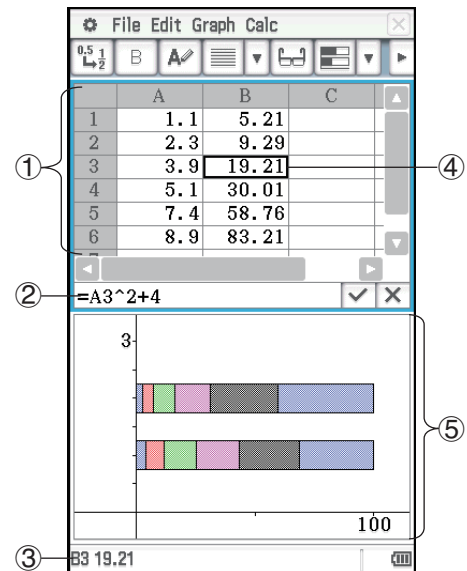













- ① Spreadsheet window
- ② Edit box ... Shows the contents of the current cell as they were input. You can tap the edit box and edit its contents.
- ③ Status bar ... Shows the location (or range) of the current cell. When a single cell is selected, the value of the cell is also shown.
- ④ Cell cursor ... Indicates the currently selected cell(s).
- ⑤ Spreadsheet Graph window



## Spreadsheet Window-Specific Menus and Buttons

The menus and buttons of the Spreadsheet window are described below. For information about the menus and buttons of the Spreadsheet Graph window, see “13-2 Graphing”.

- Transfer data between a spreadsheet and CSV files ..... File - CSV
  - Import variable data to spreadsheet .....File - Import
  - Export spreadsheet data to a variable ..... File - Export
  - Recalculate the contents of the cell(s) on the spreadsheet ..... File - Recalculate
- 
- Display a dialog box for specifying the color of the text in the cell and the cell fill color ..... Edit - Style
  - Toggle linking between text color and graph color on or off .....Edit - Format - Color Link
  - Display the Options dialog box (see “Option Settings” on page 228) ..... Edit - Format - Options
  - Automatically resize columns to fit the data into the selected cells .....Edit - Format - AutoFit Selection
  - Display a dialog box for specifying column width..... Edit - Format - Column Width
  - Display a dialog box for specifying the number format (page 36) of the selected cell(s) .....Edit - Format - Number Format
  - Display or hide the Cell Viewer window ..... Edit - Format - Cell Viewer or
  - Display a dialog box for specifying a cell to jump to ..... Edit - Select - Goto Cell
  - Display a dialog box for specifying a range of cells to select.....Edit - Select - Select Range
  - Insert row(s)/column(s) ..... Edit - Insert - Rows or / Edit - Insert - Columns or
  - Delete the currently selected row(s)/column(s) .. Edit - Delete - Rows or / Edit - Delete - Columns or

- Delete the contents of the currently selected cells..... Edit - Delete - Cells
  - Display a dialog box for specifying cell contents and a range of cells to fill..... Edit - Fill - Fill Range
  - Display a dialog box for specifying a sequence to fill a range of cells ..... Edit - Fill - Fill Sequence
  - Sort the range of selected cells on the spreadsheet..... Edit - Sort/Search - Sort,  or 
  - Search for strings in the cell(s) on the spreadsheet..... Edit - Sort/Search - Search or 
  - Search for strings in the cell(s) on the spreadsheet again..... Edit - Sort/Search - Search Again or 
- 
- Graph the data in the selected range of cells (pages 239 through 241)  
..... From Graph - Line () to Graph - Box Whisker ()
  - When graphing, treat each row/each column of the  
selected range of cells as a data pair (page 237) ..... Graph - Row Series / Graph - Column Series
- 
- Perform statistical calculations using the data  
in the selected range of cells (page 244) ..... From Calc - One-Variable to Calc - Inv. Distribution
  - Display the results of the last statistical calculation performed (page 248) ..... Calc - DispStat
  - Input a mathematical function into the currently  
selected cell (page 249) ..... From Calc - Cell-Calculation to Calc - List-Calculation
- 
- Toggle the selected cell(s) between decimal (floating point) and exact display\* .....  / 
  - Toggle the selected cell(s) between bold and normal.....  / 
  - Toggle the data type of the selected cell(s) between text and calculation.....  / 
  - Specify left-justified text and right-justified values for selected cell(s) (default) ..... 
  - Specify left-justified, centered, or right-justified for selected cell(s) ..... , , 
- \* When cell(s) are calculation data types.

## Changing the Width of a Column

You can use any one of the following methods to adjust the column width.

### • Using the stylus

Use the stylus to drag the edge of a column header left or right until the column is the desired width.

### • Using the Column Width command

1. Tap any cell in the column whose width you want to change.
  - You could also drag the stylus to select multiple columns, if you want.
2. On the [Edit] menu, tap [Format] and then [Column Width].
3. On the dialog box that appears, enter a value in the [Width] box to specify the desired width of the column in pixels.
4. Tap [OK] to change the column width.

### • Using the AutoFit Selection command

1. Select the cell you want to auto fit.
  - You can also select any range of cells. In this case, the column width is adjusted to fit the largest data value in each of the columns within the selected range of cells.
2. On the [Edit] menu, tap [Format] and then [AutoFit Selection].
  - This causes the column width to be adjusted automatically so the entire value can be displayed.
  - Note that [AutoFit Selection] also will reduce the width of a column, if applicable.

---

## Option Settings

You can use the Options dialog box to show or hide scrollbars, and specify what the cell cursor does when you register input data.

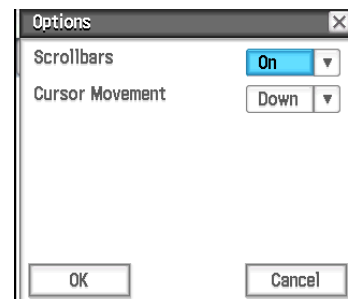

### • To change option settings

1. Tap [Edit] - [Format] - [Options] and then use the Options dialog box that appears to perform the operation described below.

To do this:	Select this:
Show the scrollbars	Scrollbars - On
Hide the scrollbars	Scrollbars - Off
Have the cell cursor remain at the current cell when you register input	Cursor Movement - Off
Have the cell cursor move to the next row below the current cell when you register input	Cursor Movement - Down
Have the cell cursor move to the next column to the right of the current cell when you register input	Cursor Movement - Right

2. After the setting is the way you want, tap [OK].

---

## 13-1 Inputting and Editing Cell Contents

### Selecting Cells

Before performing any operation on a cell, you must first select it. You can select a single cell, a range of cells, all the cells in a row or column, or all of the cells in the spreadsheet.

To select this:	Do this:
A single cell	Simply tap it with the stylus. When a single cell is selected, you can use the cursor key to move the cell cursor up, down, left, or right.
A range of cells	Drag the stylus across them. If you drag to the edge of the screen, it will scroll automatically, until you remove the stylus from the screen.
Two non-contiguous columns* <sup>1</sup>	Tap the header of one of the columns and then tap the header of the other column. For example, to select columns A and C, tap the header of column A and then the header of column C.
Two non-contiguous rows* <sup>1</sup>	Tap the header of one of the rows and then tap the header of the other row. For example, to select rows 3 and 6, tap the header of row 3 and then the header of row 6.
All the cells in a row or column	Tap a column heading to select the column, or tap a row heading to select the row.
All of the cells in the spreadsheet	Tap the box above row heading 1 (to the left of column heading A).

\*<sup>1</sup> This selection method can be used only to specify a range of data for graphing. For details about graphing, see "13-2 Graphing".

## Note

- Selection of non-contiguous rows and columns can be used for selection of up to two rows or two columns only. You cannot select more than two non-contiguous rows or columns.
- These operations are not supported when selecting rows or columns for non-graphing operations, such as statistical calculations, etc. Attempting these operations for a non-graphing operation will cause an error.

---

## Inputting Data into a Cell

The following are the basic steps you need to perform whenever inputting or editing cell data.

### • ClassPad Operation

1. Tap a cell and then tap the edit box.

- This will change the toolbar to a data input toolbar like the one shown in the nearby screenshot.

2. Input the data you want.

- You can input data using the keypad, the soft keyboard, the [Calc] menu, and the data input toolbar. See the following sections for more information.

3. After you are finished, tap the  button next to the edit box or press the **[EXE]** key.

- This causes the entire spreadsheet to be re-calculated.
- If you want to cancel data input without saving your changes, tap the  button next to the edit box or tap **Esc** on the icon panel.

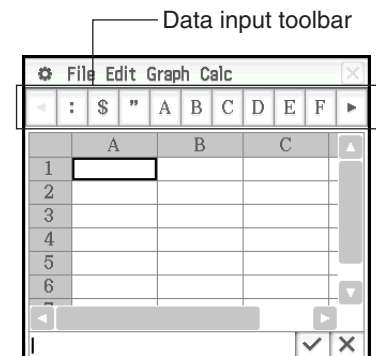

---

## Inputting a Formula

A formula is an expression that the Spreadsheet application calculates and evaluates when you input it, when data related to the formula is changed, etc. A formula always starts with an equals sign (=), and can contain values, mathematical expressions, cell references, and functions.

The screenshot to the right shows a simple example where a formula in cell B5 calculates the mean of the values in cells B1 through B3. Formulas are calculated dynamically whenever related values are changed, and the latest result is always displayed in the spreadsheet.

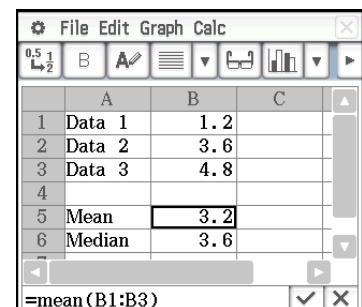

### • To input formula “=mean(B1:B3)” in cell B5

1. Tap cell B5 to select it.

2. On the [Calc] menu, tap [List-Statistics] and then [mean].

- This will cause “=mean(” to be input into the edit box.

3. Drag from cell B1 to cell B3.

- This will input “B1:B3”.

4. Tap the  button next to the edit box or press the **[EXE]** key. This will finalize input of “=mean(B1:B3)”.

- If you do not input the closing parenthesis ( ) it will be input automatically.

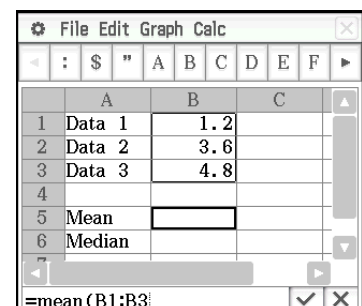
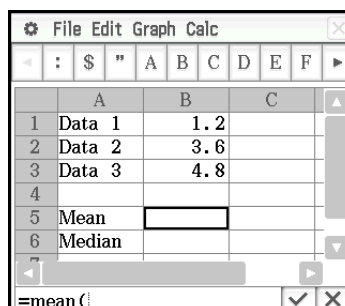

**Tip:** As in the example shown above, tapping another cell while the first character in the edit box is an equals sign (=) inserts a reference to the tapped cell into the edit box. Dragging across a range of cells will input a reference to the selected range.

---

## Inputting a Cell Reference

A cell reference is a symbol that references the value of one cell for use by another cell. If you input “=A1 + B1” into cell C2, for example, Spreadsheet will add the current value of cell A1 to the current value of cell B1, and display the result in cell C2.

There are two types of cell references: *relative* and *absolute*.

### Relative Cell Reference

A relative cell reference is one that changes according to its location on the spreadsheet. The cell reference “=A1” in cell C2, for example, is a reference to the cell located “two columns to the left and one cell up” from the current cell (C2, in this case). Because of this, if we copy or cut the contents of cell C2 and paste them into cell D12, for example, the cell reference will change automatically to “=B11”, because B11 is two columns to the left and one cell up from cell D12.

Be sure to remember that relative cell references always change dynamically in this way whenever you move them using cut and paste, or drag and drop.

However, when you cut or copy a relative cell reference from the edit box, it is copied to the clipboard as text and pasted “as-is” without changing it. If “=A1” is in cell C2 and you copy “=A1” from the edit box and paste it into cell D12, for example, D12 will also be “=A1”.

### Absolute Cell References

An absolute cell reference is one that does not change, regardless of where it is located or where it is copied to or moved to. You can make both the row and column of a cell reference absolute, or you can make only the row or only the column of a cell reference absolute, as described below.

This cell reference:	Does this:
\$A\$1	Always refers to column A, row 1.
\$A1	Always refers to column A, but the row changes dynamically when moved, as with a relative cell reference.
A\$1	Always refers to row 1, but the column changes dynamically when moved, as with a relative cell reference.

Let’s say, for example, that a reference to cell A1 is in cell C1. The following shows what each of the above cell references would become if the contents of cell C1 were copied to cell D12.

\$A\$1 → \$A\$1	\$A1 → \$A12	A\$1 → B\$1
-----------------	--------------	-------------



#### • To input a cell reference “=A1” in cell B1





1. Tap cell B1 to select it, and then input “=”.
2. Tap cell A1 or use the data input toolbar and keypad to input [A] [1].
3. Tap the  button next to the edit box or press the **[EXE]** key.









**Tip:** If you want to input an absolute cell reference, use the stylus or cursor keys to move the editing cursor to the appropriate location, and then use the editing toolbar to input a dollar (\$) symbol.

---

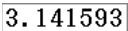

## Cell Data Types (Text Data and Calculation Data)

When a single cell is selected, the toolbar will show  when it is a text data type cell, or  if it is a calculation data type cell. When you create a new spreadsheet, all of the cells are initially text data type.

- With a text data type cell, any text or variable that does not have an equals sign (=) at the beginning is treated as text. A single value is treated as a constant value.
- With a calculation data type cell, a formula or variable that does not have an equals sign (=) at the beginning is treated as a constant value. Inputting     in a calculation data type cell, for example, will cause the value 8 (the calculation result) to appear in the cell.

When this data type is specified:	Inputting this into the cell:	Causes this to be displayed:
Text 	2	 (treated as a constant value)
	$\pi$	 (treated as text)
	2^3	 (treated as text)
Calculation 	2	 (treated as a constant value)
	$\pi$	 (treated as a constant value)
	2^3	 (treated as a constant value)

### • To specify text or calculation as the data type for a particular cell

Select the cell(s) whose data type you want to specify, and then tap the third button from the left ( / ) to toggle the data type between text and calculation.





---

## Inputting a Constant into a Calculation Data Type Cell

You can use any one of the procedures below to input constants into calculation data type cells.

- Direct input of a value or expression
- Input of the same value into all of the cells in a specific range (Fill Range)
- Input of a numeric sequence generated by a single-variable formula into a column of cells

### • To input a value or expression into a calculation data type cell

1. Tap the cell where you want to input data.
2. If  is displayed on the toolbar, tap to toggle it to .
3. Input the value or expression without inputting an equals sign (=) at the beginning.
  - You can input an expression that returns a value as a calculation result.
4. Tap the  button next to the edit box or press the  key.
  - The value you input or the calculation result of the expression you input appears in the cell.
  - “#ERR” will appear in the cell if the expression cannot be executed or if there is a syntax error.

• **To fill a range of cells with the same value (Fill Range)**

1. Select the range of cells where you want to input the same value.
  - Actually, you could skip this step and start with step 2, below.
2. On the [Edit] menu, tap [Fill] and then [Fill Range].
3. On the dialog box that appears, input the value or expression into the “Formula” box. You can also use the dialog box’s “Range” box to specify the range of cells.
4. Tap [OK].
  - The specified range of cells will automatically change to calculation data type cells, containing the value you input in step 3.

• **To fill a column of cells with a numeric sequence (Fill Sequence)**

1. Tap the cell from which you want input of the numeric sequence to start.
  - Actually, you could skip this step and start with step 2, below.
2. On the [Edit] menu, tap [Fill] and then [Fill Sequence].
3. Use the dialog box that appears to configure the Fill Sequence operation as described below.

Parameter	Description
Expr.	Input the expression whose results you want to input.
Var.	Specify the name of the variable whose value will change with each step.
Low/High	Specify the smallest/greatest value to be assigned to the variable.
Step	Specify the value that should be added to the variable value with each step.
Start	Specify the starting cell from which the results of the expression should be inserted.

4. After everything is the way you want, tap [OK].
  - This performs all the required calculations according to your settings, and inserts the results into the spreadsheet.

**Example:**

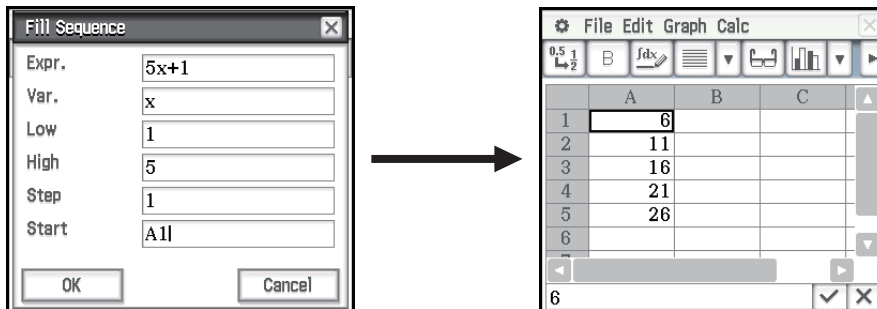



## Using the Cell Viewer Window

The Cell Viewer window lets you view both the formula contained in a cell, as well as the current value produced by the formula.

### • To view or hide the Cell Viewer window

On the Spreadsheet toolbar, tap . Or, on the Spreadsheet [Edit] menu, select [Format] - [Cell Viewer].

- The above operation toggles display of the Cell Viewer window on or off.
- On the Cell Viewer window, you can select or clear its check boxes to toggle display of the value and/or formula on or off.
- You can select a value or formula on the Cell Viewer window and then drag it to another cell, or tap [Edit] - [Copy] to place it onto the clipboard.

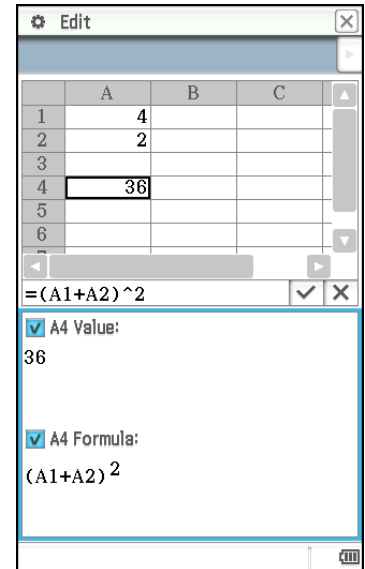

## Changing the Text Color and Fill Color of Specific Cells

For each cell, you can specify the text color and cell color.

### • ClassPad Operation

1. Select the range of cells whose text color and fill color settings you want to change.
2. On the [Edit] menu, tap [Style].
  - This displays the Style Settings dialog box.



3. Configure the above dialog box with the following settings.

To specify this:	Perform this operation:
Text color	Tap "Character Color" to display the Color Settings dialog box. Next, select the text color you want and then tap [OK].
Cell color	Tap "Area Color" to display the Color Settings dialog box. Next, select the fill color you want and then tap [OK].

4. To apply the settings you configure, return to the Style Settings dialog box and then tap [OK].

---

## Copying or Cutting Cells and Pasting Them to Another Location

Use the procedures below to copy or cut one cell or multiple cells, and then paste them to another cell or cells. For information about what happens when you copy or cut cells that include cell references and paste them to another location, see “Relative Cell Reference” (page 230).

### • To copy or cut a single cell and paste it to another cell or cells

1. Tap the cell that you want to copy or cut.
2. Tap [Edit] - [Copy] (or [Cut]).
3. Tap the cell (or drag across the range of cells) to which you want to paste the cell you copied or cut.
4. Tap [Edit] - [Paste].
  - This will paste content of the cell your copied or cut, including formatting (bold, calculation/text data type, text color, fill color).
  - If you selected a range of cells in step 3, the same content will be pasted to all of the selected cells. Note, however that if the cell you copied or cut included a relative cell reference (such as “A1”, “B2”), the content of the pasted cells will change in accordance with their relative positions.

**Tip:** You can also copy to a single cell by selecting a cell (with the cell cursor), and then dragging it to the copy destination. If the destination cell already contains data, it is replaced with the newly dropped data.

### • To copy or cut a range of cells and paste them to another location in the spreadsheet

1. Tap the range of cells that you want to copy or cut.
2. Tap [Edit] - [Copy] (or [Cut]).
3. Tap the cell that is the upper left corner of the range of paste destination cells.
4. Tap [Edit] - [Paste].
  - This will paste the contents, including formatting, of the range of cells you copied.

**Tip:** In place of the steps from step 2 of the above procedure, you could also copy the selected cells by dragging them to the copy destination. If the destination cells already contain data, it is replaced with the newly dropped data.

---

## Recalculating Spreadsheet Expressions

Recalculate is executed automatically whenever you switch to the Spreadsheet application from another application, and whenever you open a spreadsheet file.

However, you need to recalculate manually in cases like that shown in the example below.

**Example:** To plot a scatter graph using random numbers

1. Input “=rand()” into cell A1, and then copy the contents of A1 to cells A2 through A5.
2. Select cells A1:A5 and then tap [Graph] - [Scatter] to plot the scatter graph.
3. Tap the Spreadsheet window to make it active, and then tap [File] - [Recalculate].
  - Each time you tap [File] - [Recalculate], random numbers are regenerated and the graph is updated accordingly.

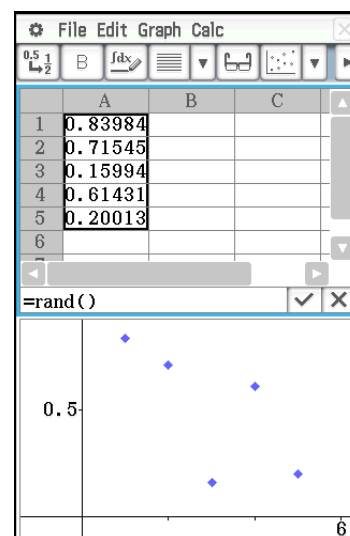

---

## Transferring Data between a Spreadsheet and CSV Files

You can import the contents of a CSV file stored with the ClassPad or transferred from a computer into a spreadsheet. You also can save the contents of a spreadsheet as a CSV file.

### • To import the contents of a CSV file to a spreadsheet

1. Prepare the CSV file you want to import.
  - See “Import CSV File Requirements” on page 134.
2. Tap [File] - [CSV] - [Open CSV].
  - Tapping [Open] in the next step will overwrite all of the data on the spreadsheet with the CSV file data.
3. On the dialog box that appears, select the CSV file you want to import and then tap [Open].

### **Important!**

Attempting to import a CSV file that has more than 64 columns or 999 rows will cause an “Invalid Data Size” error.

### • To save spreadsheet contents as a CSV file

1. If required, tap [File] - [Recalculate] to recalculate the spreadsheet contents.
  - Note that recalculation is not performed automatically when you save spreadsheet contents to a CSV file. Be sure to perform recalculation if the spreadsheet contains a formula, which starts with an equals symbol (=).
  - Formulas are not saved to the CSV file. Only calculation results are saved.
  - All ERROR cell data on the spreadsheet is saved as blank data.
2. Tap [File] - [CSV] - [Save CSV].
3. On the dialog box that appears, specify the export destination folder and then input a name for the export file.
4. Tap [Save].

### • To specify the CSV file separator and decimal symbol

Tap [File] - [CSV] - [CSV Format] to display the CSV format setting screen. Next, perform the procedure from step 2 under “To specify the CSV file separator and decimal symbol” (page 135).

---

## Importing and Exporting Variable Values

You can import LIST (list), MAT (matrix), EXPR (expression), and STR (string) variables\* into a spreadsheet. LIST, MAT, and EXPR type variable in spreadsheet data also can be exported.

\* For information about variable types, see “Main Memory Data Types” (page 28).

### • To import the data assigned to a variable

1. In a spreadsheet, tap a single cell to specify it as the import destination of the variable data.
  - If the variable you are importing is an EXPR or STR type, tapping the cell will input the variable data. For a LIST or MAT type variable, data is input as shown in examples below when cell A1 is tapped.

LIST variable “{1,2,3}”		MAT variable “[[1,2][3,4]]”*	
1	1	1	2
2	2	3	4
3	3		

\* Same as  $\begin{bmatrix} 1 & 2 \\ 3 & 4 \end{bmatrix}$

- If any of the cells within the range where variable data is being input already contain data, the existing data will be overwritten with the imported data.
  - The data type of the cells to which data is imported will automatically change to calculation data type (LIST, MAT, EXPR) or text data type (STR) in accordance with the type of variable imported into each cell.
2. On the [File] menu, tap [Import].
    - This displays the Import dialog box along with a soft keyboard.
  3. Type the variable name into the [Variable] box.
    - Tapping the  icon on the Import dialog box will display the Variable Manager, which you can use to select the variable you want. See “Using Variable Manager” (page 29) for more information.
  4. To import the specified variable data into the spreadsheet, tap [OK].

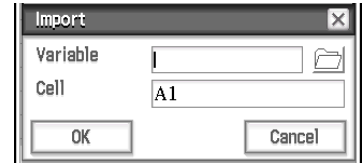

### • To export spreadsheet data to an EXPR variable

1. Select a single cell that contains the data you want to export to an EXPR variable.
  - It makes no difference whether the cell you select contains a value, expression, or string. Note that string data exported from a cell is exported as EXPR type data, not STR type data.
2. On the [File] menu, tap [Export].
  - This displays the Export dialog box along with a soft keyboard. In this case, “EXPR” will be automatically selected in the [Type] box.
3. Type the variable name into the [Variable] box.
4. After confirming that everything is the way you want, tap [OK].



### • To export spreadsheet data to a LIST or MAT (matrix) variable

1. Select the range of cells that contains the data you want to export to a LIST or MAT variable.
2. On the [File] menu, tap [Export].
3. On the dialog box that appears, tap the [Type] box down arrow button, and then select “LIST” or “MATRIX” from the list of variable types that appears.
4. Type the variable name into the [Variable] box, and then tap [OK].
  - The data in the range of cells you select in step 1 is exported as shown below, in accordance with the variable type (“LIST” or “MATRIX”) you select in step 3.

When these cells are selected in step 1:	When this is selected in step 3:	Data is exported as:												
<table border="1"> <tr><td></td><td>A</td><td>B</td></tr> <tr><td>1</td><td>1</td><td>2</td></tr> <tr><td>2</td><td>3</td><td>4</td></tr> <tr><td>3</td><td>5</td><td>6</td></tr> </table>		A	B	1	1	2	2	3	4	3	5	6	Type: LIST	{1,3,5}
	A	B												
1	1	2												
2	3	4												
3	5	6												
	Type: MATRIX	[[1][3][5]]												
<table border="1"> <tr><td></td><td>A</td><td>B</td></tr> <tr><td>1</td><td>1</td><td>2</td></tr> <tr><td>2</td><td>3</td><td>4</td></tr> <tr><td>3</td><td>5</td><td>6</td></tr> </table>		A	B	1	1	2	2	3	4	3	5	6	Type: LIST	{1,3,5,2,4,6}
	A	B												
1	1	2												
2	3	4												
3	5	6												
	Type: MATRIX	[[1,2][3,4][5,6]]												

## 13-2 Graphing

The Spreadsheet application lets you draw a variety of different graphs for analyzing data.

### Basic Graphing Steps

The following are the basic steps for graphing spreadsheet data.

#### • ClassPad Operation

1. Input the data you want to graph into the spreadsheet.
2. Select the cells that contain the data you want to graph.
3. On the [Graph] menu, tap [Column Series] to graph the data by column, or tap [Row Series] to graph the data by row.
  - For more information, see “Column Series and Row Series” below.
4. On the [Graph] menu, select the type of graph you want to draw. Or you can tap the applicable icon on the toolbar.
  - This will open the Spreadsheet Graph window in the lower half of the display and draw the selected type of graph. See “Graph Menu and Graph Examples” (page 239) for examples of the different types of graphs that are available.

**Tip:** After the graph is drawn on the Spreadsheet Graph window, you can change to another type of graph at any time by selecting the graph type you want on the [Type] menu. Or you can tap the applicable icon on the toolbar.

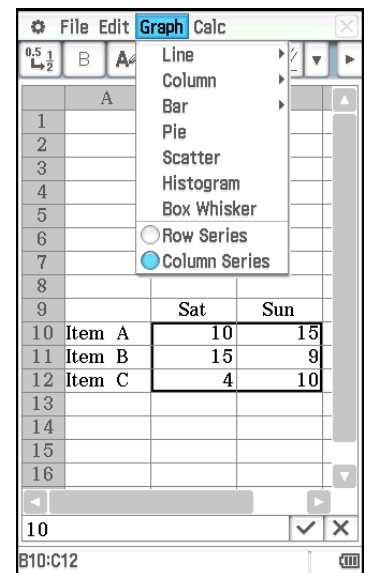

### Column Series and Row Series

For example, the nearby screenshot shows sales results for items A, B, and C during Saturday and Sunday. Let's say we select the column series and row series and draw a stacked bar graph ([Graph] - [Bar] - [Stacked]).

	A	B	C
9		Sat	Sun
10	Item A	10	15
11	Item B	15	9
12	Item C	4	10

- When [Graph] - [Column Series] is selected, each column is treated as one set of data. Since this is a stacked graph, the first set of Sat data (blue) and the second set of Sun data (red) are cumulative, and there are three bars, one for each of the three items. This lets you see the cumulative sales for each item.

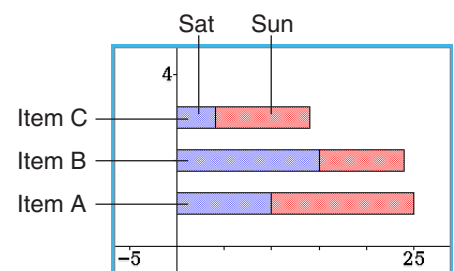

- When [Graph] - [Row Series] is selected, each row is treated as one set of data. Item A data (blue), Item B data (red), and Item C data (green) are cumulative, and there are two bars, one for each of the two days of the week. This lets you see the cumulative sales for each day.

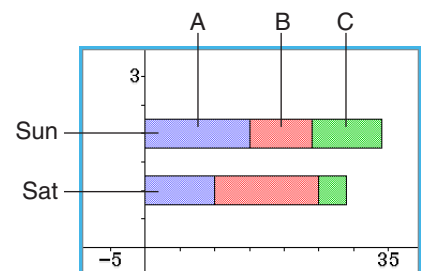

**Tip:** You can switch an existing graph between column series and row series by tapping [Type] - [Column Series] or [Type] - [Row Series].

---

## Graph Colors and Color Link

Enabling Color Link (so there is a check mark next to it) on the Edit menu will cause the text color of the data being graphed to be used when the data is graphed. Conversely, a color specified on the Graph window will be applied as the text color of the corresponding data.

When Color Link is disabled (so there is no check mark next to it on the [Edit] - [Format] menu), graphing is performed using default colors.

### • To use text colors as graph colors

**Example:** To draw a stacked line graph using the data in the nearby screenshot, which is the same we graphed under “Column Series and Row Series” (page 237)

	A	B	C
9		Sat	Sun
10	Item A	10	15
11	Item B	15	9
12	Item C	4	10
13			
14			
15			
16			
17			
18			
19			
20			
21			
22			
23			
24			
25			
26			
27			
28			
29			
30			

1. Configure text color settings for each cell as shown in the nearby screenshot.
  - For information about color settings, see “Changing the Text Color and Fill Color of Specific Cells” (page 233).
2. Tap [Graph] - [Column Series].
3. Tap [Edit] - [Format] - [Color Link] so there is a check mark next to [Color Link].
4. Tap [Graph] - [Line] - [Stacked].
  - This will draw a stacked line graph using the data colors.
5. Tap [Type] - [Row Series].
  - This switches to a row series graph. For a line graph, the color of each data’s first character (first row character in the case of Column Series, first column character in the case of Row Series) is applied as the line color.

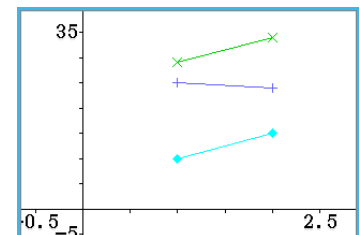
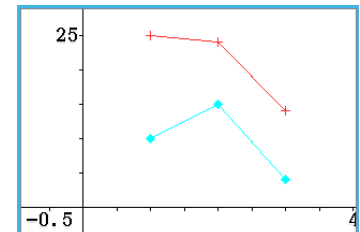

### • To specify the graph drawing color on the Graph window

**Example:** To continue with the operation in the previous example and change the drawing color on the Graph window

1. On the Graph window, select the point whose color you want to change by tapping it.
  - Note that you cannot select a line. Line colors are always the same as the rightmost end point.
2. On the [Edit] menu, tap [Style].
  - This displays the Style Settings dialog box.
3. Select the color you want and then tap [OK].
  - This will change the point to the color you selected.
  - Since there is a check mark next to [Color Link] on the [Edit] - [Format] menu, the corresponding data on the Spreadsheet window will also change to the selected color.

### Tip

- Changing the [Color Link] setting to either enabled (check mark next to it on the [Edit] - [Format] menu) or disabled (no check mark) while a graph is displayed will cause the graph to be redrawn in accordance with the newly selected enabled/disabled setting.
- When Color Link is enabled, the relationship between data text color and the graph color is as described below for each type of graph.











**Line Graph, Column graph, Bar graph:** The color of each data's first character (first row character in the case of Column Series, first column character in the case of Row Series) is applied as the color of the applicable portion (line, column, bar) of graph.



**Scatter graph:** When plotting a scatter graph of multiple different data series, the text color of the *y*-value of each data pair is used as the color of points plotted for the *y*-value. The text colors of *x*-values are ignored. When plotting a scatter graph of a single data series (selecting [Graph] - [Column Series] to graph a single column of data or [Graph] - [Row Series] to graph a single row of data) a point plotted on the graph will be the same color as the character color of the corresponding data item. When the [Lines] item of the [View] menu is enabled (indicated by a check mark next to it) on the Graph window, the color of a line is the same as the final rightmost point.

**Histogram, Box Whisker:** Histograms and box whiskers are always drawn using colors selected by ClassPad, regardless of the current Color Link enabled/disabled setting.

**Pie graph:** The text color of each data item is used as the color of the pie piece that represents the data on the graph.

## Spreadsheet Graph Window-Specific Menus and Buttons

- Change the color of a graph part selected on the Graph window ..... Edit - Style
  - Deleted the regression graph selected on the Graph window ..... Edit - Delete
  - Clear all regression graphs on the Graph window  
(except for graphs drawn using the [Graph] menu) ..... Edit - Clear All
- 
- Change the function of the stylus so it can be used to select  
and move points on the displayed graph ..... View - Select or 
  - Pan the graph window ..... View - Pan or 
  - Adjust the size of the display image so it fills the display ..... View - Zoom to Fit or 
  - Toggle display of axes and coordinate values on or off ..... View - Toggle Axes or 
  - Toggle line graph and scatter graph plot markers on or off ..... View - Markers
  - Toggle line graph and scatter graph connecting lines on or off ..... View - Lines
- 
- Change the graph type (pages 239 through 241) ..... From Type - Line () to Type - Box Whisker ()
  - Switch between row and column for handling one group of graphed data (page 237)  
..... Type - Row Series / Type - Column Series
  - Draw a regression graph and display regression calculation results (page 242)  
..... From Calc - Regression - Linear Reg () to Calc - Regression - Logistic Reg ()
  - Show or hide (check box) of calculation results  
when the regression graph draw command is selected ..... Calc - DispStat
  - Convert the data of the selected column to a line graph ..... Calc - Line or 
  - Convert the data of the selected line to a column graph ..... Calc - Column or 
  - Set bin width for a histogram ..... Calc - Bin Width
  - Show outlying data for box whisker graph ..... Calc - Show Outliers

**Tip:** The View menu Zoom Box () , Zoom In () , and Zoom Out () commands are the same as the Graph & Table application Box, Zoom In, and Zoom Out commands on the Zoom menu. For more information about these commands, see “Chapter 3: Graph & Table Application”.



## Graph Menu and Graph Examples

The following explains each of the [Graph] menu commands, and shows examples of what happens to the Graph window when you execute a command. Each command is followed by a button to show the graph toolbar button that performs the same action as the command.

**Tip:** The contents of the Spreadsheet window [Graph] menu and the Graph window [Type] menu are identical. On the Graph window, you can use the [Type] menu or the applicable icon on the toolbar to change the graph type after a graph is drawn.

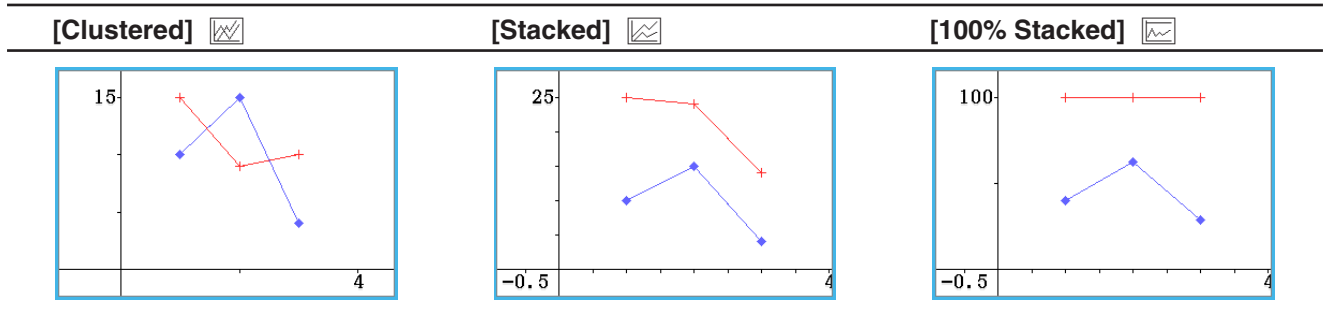

**[Graph] - [Line] -**

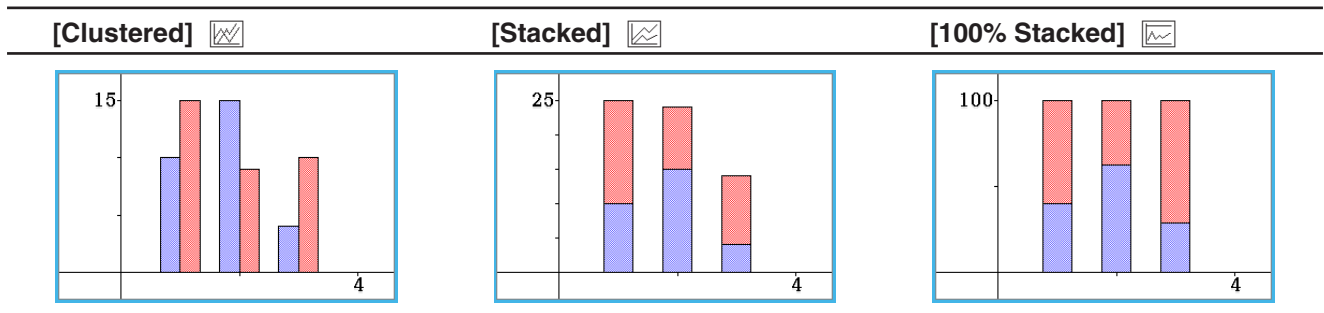

- After drawing a clustered line graph, you can change a line in the graph to a column graph. To do this, tap any data point on the line you wish to change to a column graph, and then tap [Column] on the [Calc] menu or tap . You can change a column graph back to a line graph by selecting one of its columns and tapping  or [Line] on the [Calc] menu.

**[Graph] - [Column] -**



- After drawing a clustered Column graph, you can change a column in the graph to a line graph. To do this, tap any one of the columns you wish to change to a line graph, and then tap [Column] on the [Calc] menu or tap . You can change a line graph back to a column graph by selecting one of its data points and tapping  or [Column] on the [Calc] menu.

**[Graph] - [Bar] -**

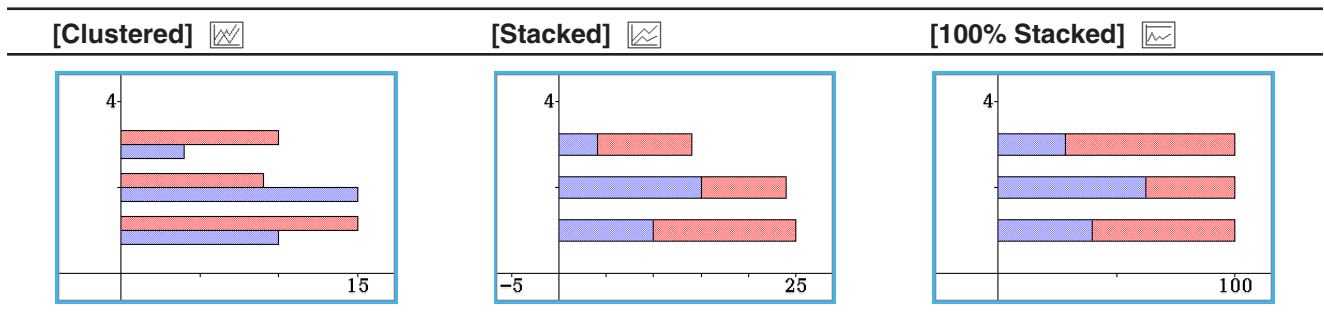

**[Graph] - [Pie] **

- When you select a pie chart, only the first series (column or row) of the selected data is used.
- Tapping any of the sections of a pie graph causes three values to appear at the bottom of the screen: the cell location, a data value for the section, and a percent value that indicates the portion of the total data that the data value represents.

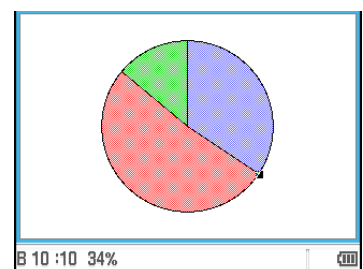



### [Graph] - [Scatter]

- When plotting a scatter graph of multiple different data series, the first series (column or row) of selected values is used as the  $x$ -values for all plots. The other selected values are used as the  $y$ -value for each of the plots. This means if you select three columns of data (like Columns A, B, and C), for example, there will be two different plot point types: (A, B) and (A, C).
- When plotting a scatter graph of a single data series (selecting [Graph] - [Column Series] to graph a single column of data or [Graph] - [Row Series] to graph a single row of data),  $x$ -axis data numbers (1, 2, 3...) are fixed and each data item is plotted on the  $y$ -axis.
- Scatter graphs initially have plotted points only. You can add lines by selecting [Lines] on the [View] menu.

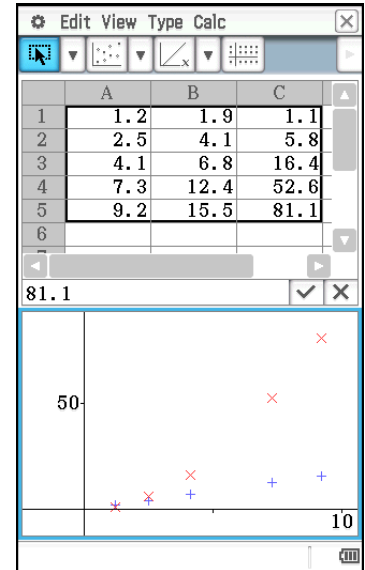

### [Graph] - [Histogram]

- When you select a histogram graph, only the first series (column or row) of the selected data is used.
- Tapping any of the bins of a histogram graph causes three values to appear at the bottom of the screen. The first two values (from the left) indicate the range of the selected bin, while the third value indicates the quantity of the selected bin.
- You can specify the bin width after drawing a histogram graph. On the Spreadsheet Graph window that shows the histogram, tap [Bin Width] on the [Calc] menu.

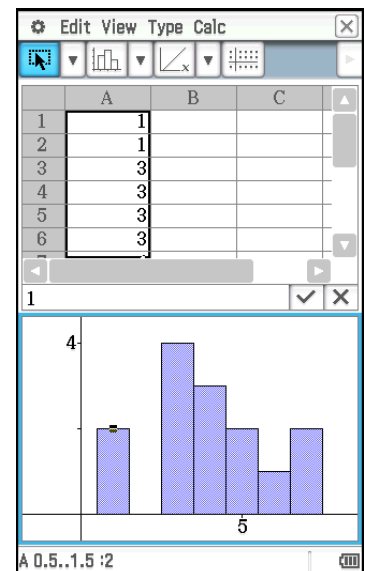

### [Graph] - [Box Whisker]

This type of graph lets you see how a large number of data items are grouped within specific ranges. The lines from Min to  $Q_1$ , and from  $Q_3$  to Max are called “whiskers”. If [Calc] - [Show Outliers] box is checked on the Spreadsheet Graph window, “outlier” circular symbols are shown instead of “whisker” lines where a data value is relatively large or small compared to the other data values.

- When you select a box whisker graph, each column will be displayed as a separate box whisker.
- Tapping the  $Q_1$ ,  $Q_3$ , Med, Min, or Max location of a box whisker graph will cause the applicable value to appear at the bottom of the screen.

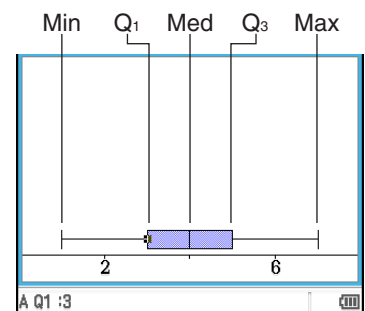













## Regression Graph Operations (Curve Fitting)

After plotting a scatter graph using paired-variable ( $x, y$ ) data on the spreadsheet, you can draw a regression graph that approximates the scatter graph and determine the regression formula.

### • To plot a scatter graph and then draw its regression graph

1. Enter the paired-variable data into the spreadsheet, and then select the range of cells where it is located.
  - For information about how data is treated based on the range of cells that are selected, see “[Graph] - [Scatter]” (page 241) under “Graph Menu and Graph Examples”.
2. Tap [Graph] and then [Scatter].
  - This will open the Graph window in the lower half of the display and plot the scatter graph.
3. When plotting a scatter graph with multiple  $y$ -values, select one of the  $y$ -value plots that you want to use for drawing the regression graph by tapping it.
4. On the Graph window, perform the following steps.

To draw this:	Select this [Calc] menu item:	Or tap this:
Linear regression curve	Linear Reg	
Med-Med graph	MedMed Line	
Quadratic regression curve	Quadratic Reg	
Cubic regression curve	Cubic Reg	
Quartic regression curve	Quartic Reg	
Quintic regression curve	Quintic Reg	
Logarithmic regression curve	Logarithmic Reg	
Exponential $a \cdot e^{bx}$ regression curve	Exponential Reg	
Exponential $a \cdot b^x$ regression curve	abExponential Reg	
Power regression curve	Power Reg	
Sinusoidal regression curve	Sinusoidal Reg	
Logistic regression curve	Logistic Reg	

- This superimposes the regression graph on the scatter graph. Also, the regression calculation result window will appear in the upper half of the display (except for Quintic Reg).
  - Here, you can add another regression graph by selecting a different [Calc] menu item. Also, you can repeat step 3 to overlay a regression graph for a different  $y$ -value.
5. To clear all regression graphs, tap [Edit] - [Clear All].
    - You can also delete a particular regression graph by tapping to select it, and then tapping [Edit] - [Delete].

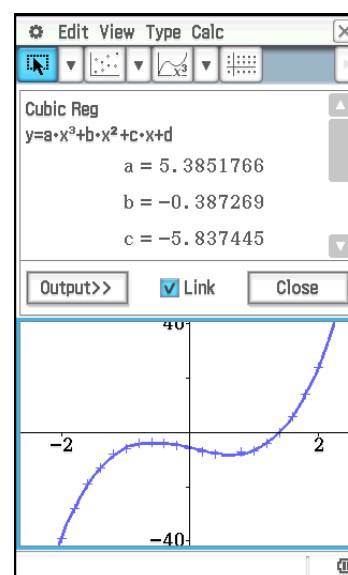

## Tip

- Regression graphs are normally drawn in blue, but you can change the color after drawing is complete. To change the color after drawing is complete, tap the graph and then tap [Edit] - [Style] to display the Style Settings dialog box. Perform the procedure under “To specify the graph drawing color on the Graph window” (page 238) to change the color.
- Exponential and abExponential regression curves ignore negative values when calculating the curve. A message appears in the status bar to let you know when negative values are ignored.
- On the Graph window, after tapping a regression graph to select it you can drag it to the Spreadsheet window and drop it into a cell to paste the function of the regression graph into the cell. You can also achieve the same result by tapping the regression graph, tapping [Edit] - [Copy] (or [Edit] - [Cut]), tapping a cell in the Spreadsheet window, and then tapping [Edit] - [Paste]. Note that if you perform an [Edit] - [Cut] operation, the regression graph will be deleted from the Graph window.
- For details about how to use the Link check box and [Output>>] button on the regression calculation result window, see “To execute a regression calculation and paste the results into the spreadsheet” (page 245).

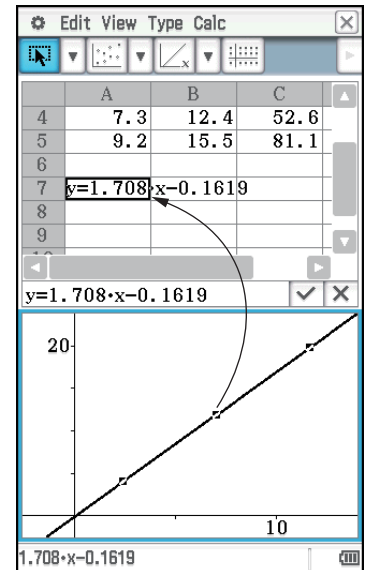

## Other Graph Window Operations

This section provides more details about the types of operations you can perform while the Graph window is on the display.

### • To change the appearance of a graph by dragging a point

While a graph is on the Graph window, use the stylus to drag any one of its data points to change the configuration of the graph.

- You can change curves, make bars or columns longer or shorter, or change the size of pie graph sections.
- Changing a graph automatically changes the graph's data on the Spreadsheet window.

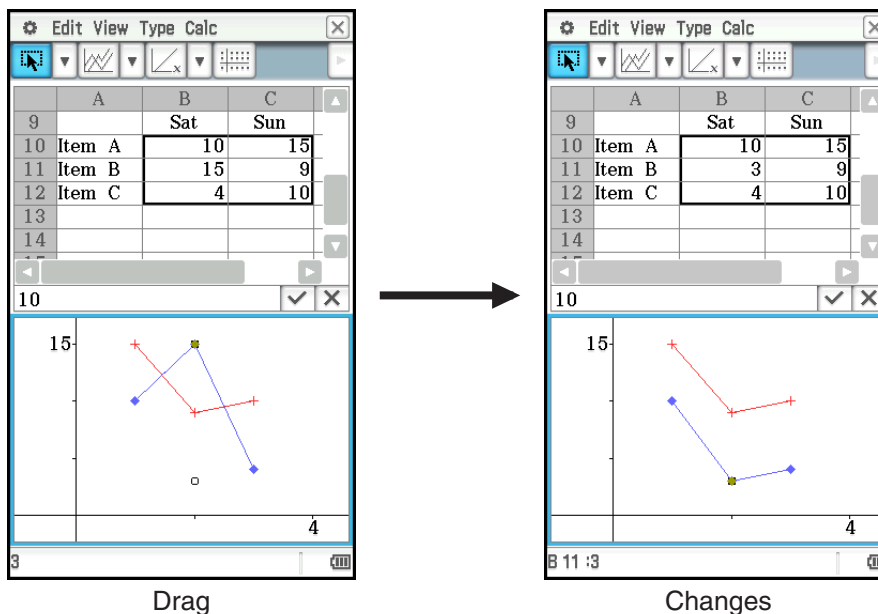

- If a regression curve is displayed for the data whose graph is being changed by dragging, the regression curve also changes automatically in accordance with the drag changes.
- When you edit data in the spreadsheet and press **[EXE]**, your graph will update automatically.

**Important!**

- You can drag a point only if it corresponds to a fixed value on the spreadsheet. You cannot drag a point if it corresponds to a formula.
- You may encounter the message “Insufficient System Memory to Run...” if you are using a large amount of data and formulas.

**• To use drag and drop to obtain the data of a graph**

While a graph is on the Graph window, you can select a part of the graph (point, bar, etc.) and drop it into a Spreadsheet window cell. This will import the graph data into the spreadsheet. The data that is imported depends on the graph type.

<b>Dragging this to a cell in the spreadsheet window:</b>	<b>Creates a table containing these values starting from the cell where you dropped the data:</b>
A point of a line graph, a column of a column graph, or a bar of a bar graph	All of the values in the series associated with the point, column, or bar
A point of a scatter graph	All (x, y) values of the series associated with the point
A pieces of a pie graph	A percentage value relative to the entire pie graph
Any of the bins of a histogram graph	The values of the histogram graph
Any of the Q <sub>1</sub> , Q <sub>3</sub> , Med, Min, or Max location of a box whisker graph	The graph's values (Min, Q <sub>1</sub> , Median, Q <sub>3</sub> , Max)

**• To show or hide lines and markers for a line graph or a scatter graph**

1. While a line graph or a scatter graph is on the Graph window, tap the [View] menu.
2. Tap the [Markers] or [Lines] item to toggle it between show (check box selected) and hide (check box cleared).
  - Line and scatter graphs can have markers only, lines only, or both markers and lines. You cannot turn off both markers and lines at the same time.

## 13-3 Statistical Calculations

The upper part of the [Calc] menu includes the same menu items as the Statistics Application [Calc] menu.

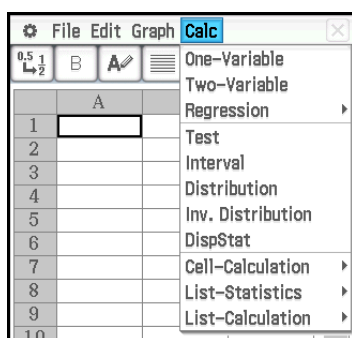

Spreadsheet Application

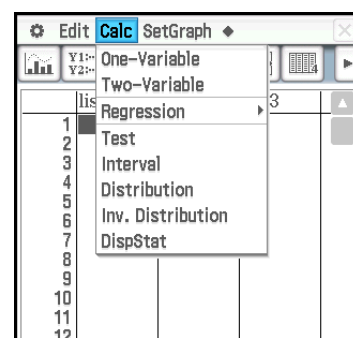

Statistics Application

Menu items with the same name perform the same functions, but there are some differences between the Statistics Application and Spreadsheet Application in terms of operation procedures, calculation result display, etc. This section explains statistical operations and functions that are peculiar to the Spreadsheet Application.

## Single-variable, Paired-variable and Regression Calculations

When performing these calculations, you need to prepare data of one of the formats shown below.

(a)

X1
X2
X3
⋮

Single-variable Data

(b)

X1	Freq 1
X2	Freq 2
X3	Freq 3
⋮	⋮

Single-variable Data  
with Frequencies

(c)

X1	Y1
X2	Y2
X3	Y3
⋮	⋮

Paired-variable Data

(d)

X1	Y1	Freq 1
X2	Y2	Freq 2
X3	Y3	Freq 3
⋮	⋮	⋮

Paired-variable Data  
with Frequencies

To perform this type of calculation:	Prepare this type of data:
Single-variable calculations	(a) or (b)
Paired-variable and regression calculations	(c) or (d)

For any of the above calculations, selecting a command displays a wizard screen. The example below shows how to perform a regression calculation.

### • To execute a regression calculation and paste the results into the spreadsheet

- Enter the paired-variable data into the spreadsheet, and then select the range of cells where it is located.
- On the menu bar, tap [Calc] and then [Regression]. Next, on the submenu that appears, tap the desired regression type.
  - This displays a window which shows calculation results along with the model formula for the selected regression type in the lower half of the display.
  - For details about each regression type, see “Regression types” (page 138). For information about calculation results other than model formula coefficients, ( $r$ ,  $MSe$ , etc.), see “To view regression calculation results” (page 143).
- On the calculation result window, tap the [Output>>] button.
  - You can use this screen to specify the data to be output to the spreadsheet. Under initial default settings, the Labels and Results check boxes are selected. Select the check boxes of the items you want to output.
- On the output window, tap [Paste].
  - This pastes a table of system variable labels to which regression calculation results are assigned, the regression calculation results, and residual values (items whose check boxes are selected).

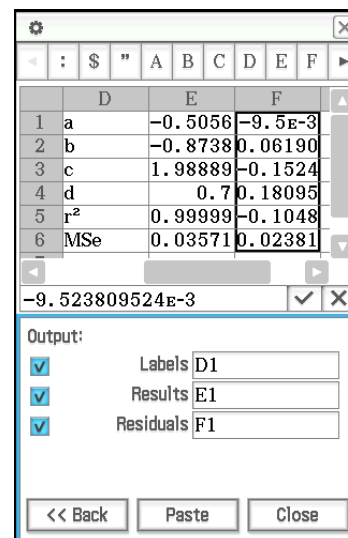
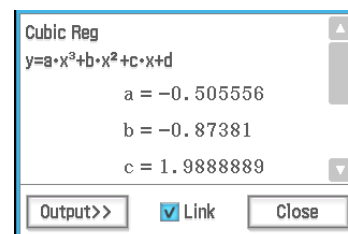

#### Link check box

Changing the range of data you selected on the Spreadsheet window in step 1 above will cause the regression calculation results displayed on the calculation result window to be updated automatically. You can disable automatic updating (if you feel that updating is taking too long or for any other reason) by clearing the Link check box on the calculation result window.

**Tip:** For information about regression graphing, see “Regression Graph Operations (Curve Fitting)” (page 242).

---

## Test and Interval Calculations

These calculations use the exact same wizard as the Statistics application.

For details about each calculation, see “Tests” (page 146) and “Confidence Intervals” (page 149) in “7-4 Performing Advanced Statistical Calculations”. For information about command syntax, see “12-4 Program Command Reference”.

The following are the differences between these calculations and the Statistics application.

- For the Linear Regression  $t$  Test,  $\chi^2$  Test,  $\chi^2$  GOF Test, One-Way ANOVA, and Two-Way ANOVA commands, you need to input data to be used in the calculation into the spreadsheet beforehand.
- The other commands are always executed using a variable type syntax. Values can be input directly on the wizard screen, or they can be input into a spreadsheet and referenced from there. One line of spreadsheet data is used for one calculation execution, so calculations can be batch executed by providing the required number of data lines. For an actual execution example, see “Z Tests,  $t$  Tests, Two-Sample  $F$  Test, and Interval Calculations” below.
- After the calculation result window is displayed, an output window can be displayed for outputting calculation result data to the spreadsheet.

### Formats of Data Used for Calculation and Example Calculation

This section specifies the data formats for the data input in the spreadsheet for each type of calculation, and shows an example of an actual calculation.  $m$  and  $n$  used in the explanation text below represent any two natural numbers.

### Z Tests, $t$ Tests, Two-Sample $F$ Test, and Interval Calculations

- Operation when inputting values directly on the wizard screen and performing the calculation is identical to that when “Variable” is elected on the Statistics operation wizard screen.
- When the number of numeric input fields on the wizard screen is  $m$ , prepare  $n$  rows and  $m$  columns of data. For example, in the case of the 1-Sample Z Test, there are four numeric input fields as shown in the nearby screenshot. In this case, selecting 2 rows  $\times$  4 columns of data (A1:D2) on the spreadsheet and running the wizard will automatically input cell references into each field as shown in the nearby screenshot. Increasing the number of rows causes batch calculation of each line to be performed.

#### Important!

When you want to batch execute multiple calculations, be sure to input a set of data for each calculation in each line. Calculation cannot be performed on the wizard screen when data is grouped by columns.

**Example:** To prepare the data shown in the nearby screenshot, select the range A2:D4, and execute the 1-Sample Z Test. In this case, the  $\mu$  condition is  $\neq$  ( $\mu \neq 0$ ).

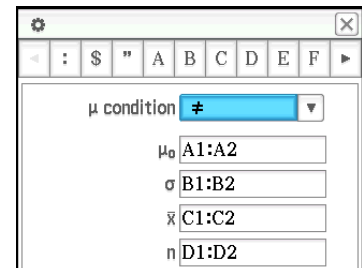

	A	B	C	D	
1	$\mu_0$	$\sigma$	$\bar{x}$	n	
2	0	3	24	48	
3	0	3	24.5	48	
4	0	3	25	48	

1. On the Spreadsheet window, input the data and then select input range cells A2:D4.
2. Tap [Calc] - [Test] - [One-Sample Z-Test], and then tap [Next>>].
3. This will automatically insert the cell references into the fields as shown in the nearby screenshot (lower half).
  - You can also directly input reference cell ranges for each field. If you do, however, you can specify in the column direction (such as A1:A3). Specifying in the row direction (such as A1:C1) will cause an error.

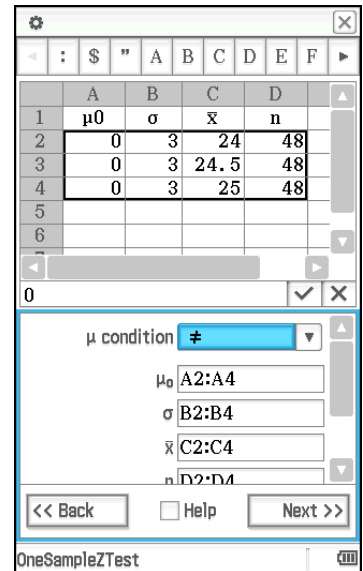

4. Tap [Next>>].
  - A calculation is executed for each line of input data, which obtains three results for  $z$  value. The calculation results for each line can be displayed by tapping the down arrow button ( $\nabla$ ) of each field on the calculation result window.

z	55.425626
	55.425626
	56.580326
	57.735027

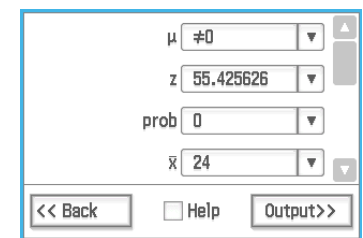

5. To graph the calculation results as a normal distribution graph, tap  $\Psi$ .

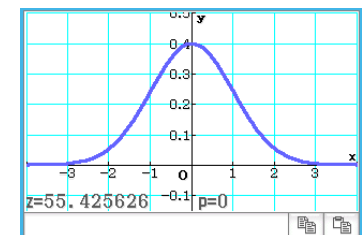

## Linear Regression $t$ Test

In a spreadsheet, input paired-variable data (page 245 (c) or (d)) as test data.

**1301** To perform a Linear Regression  $t$  Test on the paired-variable data shown in the nearby screenshot

	A	B	C
1	38	41	10
2	56	63	11
3	59	70	10
4	64	72	10
5	74	84	12

## $\chi^2$ Test

For test data, input data of at least one row and two columns (observed matrix) into the spreadsheet. You can see an actual example (**0704**) of how this is done using the Statistics application in Chapter 7 of this manual.

## $\chi^2$ GOF Test

For test data, input two lists (observed list and expected list) into the spreadsheet. This is equivalent to inputting two rows of data of  $n$  lines. You can see an actual example (**0705**) of how this is done using the Statistics application in Chapter 7 of this manual.

## One-Way ANOVA

For test data, input data (Factor A) into the spreadsheet that is  $n$  rows  $\times$  2 columns up to  $n \times 6$  columns. You can see an actual example (**0706**) of how this is done using the Statistics application in Chapter 7 of this manual.

## Two-Way ANOVA

When (Factor A count)  $\times$  (Factor B count) =  $m$ , prepare test data that is  $n$  rows  $\times$   $m$  columns. For example, when there are Factor A items and one Factor B items, input six columns of data into the spreadsheet. For example, select A1:F3 on the spreadsheet and run the wizard. This will automatically assign the cell references shown below to each factor.

	Factor B1	Factor B2	Factor B3
Factor A1	A1:A3	B1:B3	C1:C3
Factor A2	D1:D3	E1:E3	F1:F3

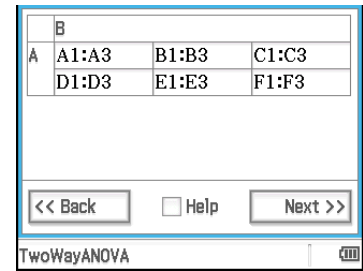

**1302** To perform the same calculation as Statistics application example **0707** using the Spreadsheet application



## Distribution Calculations

For details about the different types of distribution calculations, see “Distributions” (page 151).

### • To perform a distribution calculation and paste the results into the spreadsheet

1. Enter the single-variable or paired-variable data into the spreadsheet, and then select the range of cells where it is located.
  - The following shows the types of data that correspond to each type of distribution calculation, and the variables that will be assigned the range of selected data.

Distribution Type	Data	Variable Assignment
Probability Density	Single-variable	$x$
Cumulative Distribution	Paired-variable	Lower, Upper
Inverse Cumulative Distribution	Single-variable	$prob$

2. On the menu bar, tap [Calc] and then [Distribution].
  - The Distribution Calculation Wizard will appear in the lower half of the display.
3. Tap the  button to the right of the second item from the top and then select the desired distribution calculation from the menu that appears.
4. Tap [Next >>].
  - This will display a screen with the variable assignments for the range you selected in step 1 of this procedure entered automatically in the input fields as the initial defaults.
5. Enter values for the other variables and then tap [Next >>].
  - This displays the calculation results. If there are multiple calculation results, tap  to view them.
  - You can tap  here to display the distribution graph.
6. On the calculation result window, tap the [Output>>] button.
7. On the output window, tap [Paste].
  - This pastes the calculation results in formula format.

## About DispStat Command

Tapping [Calc] - [DispStat] displays a DispStat window that displays statistical calculation (one-variable, two-variable, regression, test, interval, distribution, or inverse distribution calculations) results after a calculation is performed.



**Tip:** The DispStat window shows statistical calculation results of the last statistical calculation that was executed using any ClassPad application (except for eActivity). For example, immediately after a calculation is executed using “NormPD” command in the Main application, that calculation result is displayed on the DispStat window, even with the Spreadsheet application. However, note that calculation results produced using a mathematical function, such as “normPDF(”, are not displayed on the DispStat window.

## 13-4 Cell and List Calculations

### Using the Cell Calculation Functions

Spreadsheet application special functions are included on the [Cell-Calculation] submenu of the [Calc] menu. Selecting a menu item on the [Cell-Calculation] submenu will input the corresponding function into the currently selected cell. This section provides explanations of the functions and input syntax of the cell calculation functions.

Function	Description
row	Function: Returns the row number of a specified cell. Syntax: row(cell)
col	Function: Returns the column number of a specified cell. Syntax: col(cell)
count	Function: Returns a count of the number of cells in the specified range. Syntax: count(start cell[:end cell])
cellif	Function: Evaluates an equality or inequality, and returns one of three different expressions based on whether the equality/inequality is true (expression 1), false (expression 2), or inconclusive (expression 3). With this function, the equality/inequality can include a string as in the following example: cellif(A1="Red", 0,1,2). Syntax: cellif(equation, expression 1, expression 2, expression 3) cellif(inequality, expression 1, expression 2, expression 3)

**1303** For each value in cells A1 through A5, to display “Big” in the neighboring B-column cell for values of 5 and greater, and “Small” for values less than 5

### Using the List Calculation Functions

The [Calc] menu functions shown in the table below are also included (with the same name) on the Main application [Action] - [List] - [Statistics] and [Action] - [List] - [Calculation] submenus.

[Calc] - [List-Statistics] submenu	min, max, mean, median, mode, Q <sub>1</sub> , Q <sub>3</sub> , percentile, stdDev, variance
[Calc] - [List-Calculation] submenu	sum, prod, cuml, ∆list, percent, polyEval, sequence, sumSeq

Selecting a menu item on the [Calc] - [List-Statistics] submenu or [Calc] - [List-Calculation] submenu will input the corresponding function into the currently selected cell. For information about the syntax and other details about each function, see “Using the List-Statistics and List-Calculation Submenus” (page 72).

**Tip:** When a range of cells on a spreadsheet is specified as the arguments of these functions, the cells are regarded of a single list of data even if the range extends over multiple columns. For example, in the case of the nearby screenshot (where the range A1:B3 is selected), the data is treated as the following list data: {1,3,5,2,4,6}.

	A	B
1	1	2
2	3	4
3	5	6

**1304** To determine the mean of the values in the block whose upper left corner is located at A1 and whose lower right corner is located at C3, and input the result in cell C5

	A	B
1	1	5
2	2	4
3	3	6

**1305** When Column A is data and Column B is frequency, to totalize the data input in A1 through B3 in the nearby screenshot and input the total into cell B5

# Chapter 14: 3D Graph Application

The 3D Graph application lets you draw a 3-dimensional graph of an equation in the form  $z = f(x, y)$  or of a parametric equation.

The 3D Graph application has a 3D Graph Editor window (①) and a 3D Graph window (②). Functions you input on the 3D Graph Editor window are graphed on the 3D Graph window. You can select any one of the expressions on the 3D Graph Editor window and graph it on the 3D Graph window.

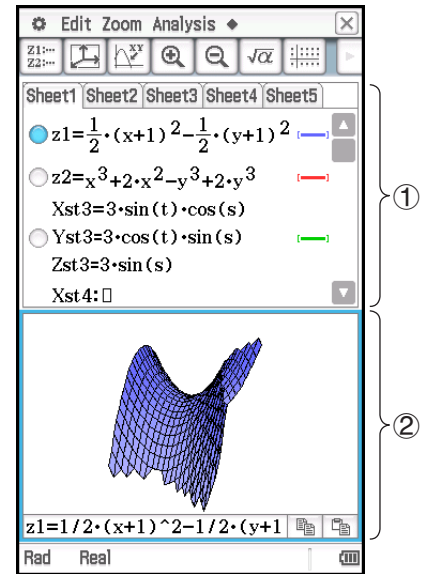

## 3D Graph Application-Specific Menus and Buttons

### 3D Graph Editor window

- Delete text in a selected area. When nothing is selected, deleted the entire line where the cursor is located. .... Edit - Delete or
- Return the current sheet to its initial default name (Sheet 1 through Sheet 5) ..... Sheet - Default Name
- Return the contents and name of the currently active sheet to their initial defaults..... Sheet - Clear Sheet
- Draw a graph .....
- Toggle the equation type between  $z = f(x, y)$  and a parametric equation ..... Xst / Z=
- Insert variable  $s$  or  $t$  into a parametric equation ..... s / t

### 3D Graph window

- View the displayed graph from the  $x$ -axis,  $y$ -axis, or  $z$ -axis..... Zoom - View- $x$ , View- $y$ , View- $z$
- Return View Window settings and zoom settings to their initial defaults .....Zoom - View-Init
- Make the 3D Graph Editor window active.....
- Display the coordinates at a particular point on a 3D graph .....Analysis - Trace or
- Write text on the Graph window ..... Analysis - Sketch - Text
- Clear text on the Graph window.....Analysis - Sketch - Cls
- Calculate a  $z$ -value for given  $x$ - and  $y$ -values, or  $s$ - and  $t$ -values, on the displayed graph..... Analysis -  $z$ -Cal
- Automatically rotate a graph in the specified direction (Left  $\rightarrow$  Right, Right  $\rightarrow$  Left, Top  $\rightarrow$  Bottom, Bottom  $\rightarrow$  Top) for about 30 seconds ..... - Rotating
- Re-draw a graph ..... - ReDraw
- Show/hide axes and labels .....

### 3D Graph Editor window and 3D Graph window

- Display the View Window dialog box to configure 3D Graph window settings ..... 
- Display the Main application work area window ..... 

## 14-1 Inputting an Expression

Use the 3D Graph Editor window to input 3D Graph application expressions.

### Using 3D Graph Editor Sheets

3D Graph Editor sheet operations are similar to the sheet operations of the Graph & Table application. For more information, see “Using Graph Editor Sheets” on page 99.

**Note:** The Graph & Table application allows simultaneous graphing of multiple functions, as long as they are on the same sheet. With the 3D Graph application, however, you can graph only one function at a time.

### Storing a Function

To input an expression, tap a blank line on the 3D Graph Editor window and then perform the operations described below.

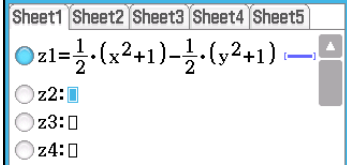
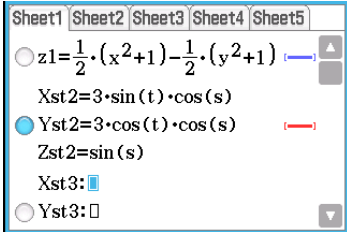
To input this type of expression:	Do this:	
$z = f(x, y)$ expression	<ol style="list-style-type: none"> <li>1. If <math>\overline{Xst}</math> is displayed on the toolbar, tap to toggle it to <math>\overline{Z=}</math>.</li> <li>2. Input a formula that includes the variables <math>x</math> and <math>y</math> (such as <math>\frac{1}{2}(x^2 + 1) - \frac{1}{2}(y^2 + 1)</math>) and then press <math>\overline{EXE}</math>.</li> </ol>	
Parametric expressions	<ol style="list-style-type: none"> <li>1. If <math>\overline{Z=}</math> is displayed on the toolbar, tap to toggle it to <math>\overline{Xst}</math>.</li> <li>2. In the Xst =, Yst =, and Zst = lines, input expressions that each contain <math>s</math> and/or <math>t</math> (such as: <math>3\sin(t)\cos(s)</math>), and then press <math>\overline{EXE}</math>.</li> </ol>	

## Graphing a Stored Function

### • To graph a specified function

1. Tap the tab of the sheet that contains the function you want to graph to make it active.
2. Tap the button to the left of the formula you want to graph so it changes from  to .
3. Change the graph line color and area color as desired.
  - See “To specify the graph line color and area color” below.
4. Tap  to graph.

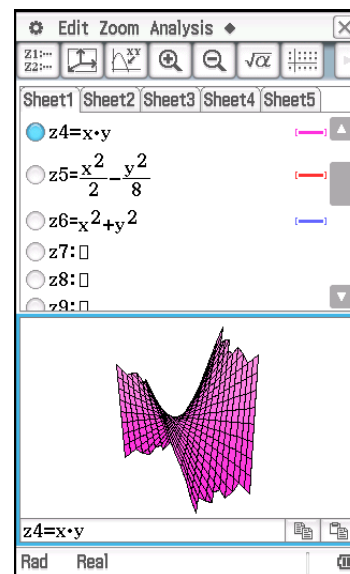

**Tip:** You can also use drag and drop to input an expression displayed on the Main application work area into the 3D Graph Editor window. To do this, perform the same steps as those for the Graph & Table application. For more information, see “To graph a function by dragging it from the work area to the Graph window” on page 92.

### • To specify the graph line color and area color

1. Tap the style area next to the function whose line style and color you want to specify. This displays the Style Settings dialog box.
2. Configure the dialog box with the following settings.

To specify this:	Perform this operation:
Line color	Tap “Line Color” and then tap the desired color.
Area color	Tap “Area Color” and then tap the desired area color.

- “Clear” cannot be specified for both the “Line color” and “Area color” at the same time.
3. To apply the settings, return to the dialog box in step 2 of this procedure and then tap [OK].
  4. To redraw the graph with the new settings, tap .

### Graph examples using different settings

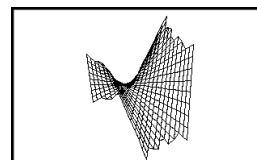
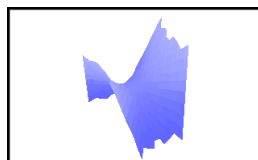
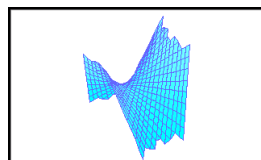
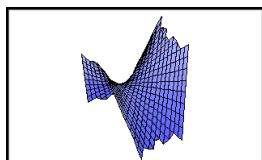

Line Color:            Black  
Area Color:            Blue

Line Color:            Blue  
Area Color:            Cyan

Line Color:            Clear  
Area Color:            Blue

Line Color:            Black  
Area Color:            Clear

## 14-2 Using the 3D Graph Window

This section explains 3D Graph window operations, including configuring display settings, changing the angle of a graph, rotating a graph, and more.



### Configuring 3D Graph View Window Parameters

Use the 3D Graph View Window to specify maximum and minimum values for the  $x$ -axis,  $y$ -axis,  $z$ -axis,  $s$ -variable, and  $t$ -variable.

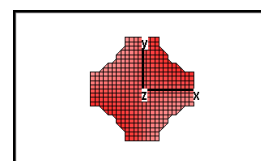
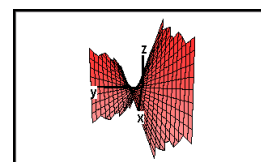
You can also specify the number of lines you would like for drawing the grid. For the  $xgrid$  enter the number of lines you would like drawn within the interval from  $xmin$  to  $xmax$ . For example, if  $xmin = -3$ ,  $xmax = 3$  and  $xgrid = 15$ , 15 almost vertical lines will be used to display your graph. The  $ygrid$  lines will be almost horizontal.



#### • To configure View Window parameters

1. Tap , or tap  and then [View Window] to display the View Window dialog box.
2. Configure View Window parameters required for the type of graph you want to draw.

Use this item:	To configure this View Window parameter:	Initial default
$xmin/ymin/zmin$	Minimum $x$ -axis/ $y$ -axis/ $z$ -axis value	-3
$xmax/ymax/zmax$	Maximum $x$ -axis/ $y$ -axis/ $z$ -axis value	3
$xgrid/ygrid$	Number of grid lines used for $x$ -axis/ $y$ -axis direction	25
angle $\theta$	Clockwise angle of $x$ -axis	20
angle $\phi$	Eye position relative to the plane created by the $x$ -axis and $y$ -axis, and the angle of the $z$ -axis	70
$smin/tmin$	Minimum $s$ -variable/ $t$ -variable value	-3.14159265358979
$smax/tmax$	Maximum $s$ -variable/ $t$ -variable value	3.14159265358979

3. After all the parameters are the way you want, tap [OK].

- When you tap [OK] after changing View Window dialog box settings, the graph is redrawn automatically using the new View Window settings.

The following are examples of the 3D graph  $z = xy$  using a number of different 3D View Window setups.

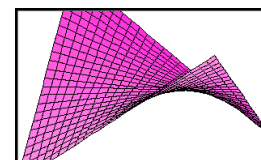
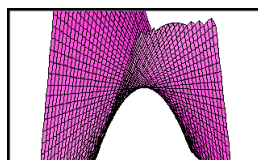
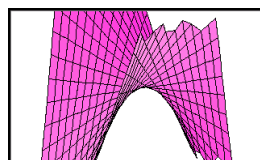
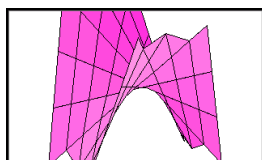

$xgrid, ygrid$	10	25	50	25
$xmin, ymin$	-3	-3	-3	-1.5
$xmax, ymax$	3	3	3	1.5



#### **Important!**

- As is evident from the above sample screenshots, the greater the  $xgrid$  and  $ygrid$  values, the more detailed the graph. Also note, however, that larger values require more calculation, which means that the graphing operation takes more time.
- Graphing may be impossible if the  $xgrid$  and  $ygrid$  values are too small.

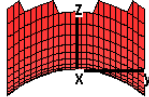
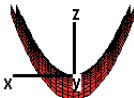
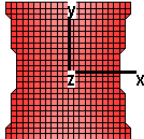
• **To switch the eye position**



To view the graph: Do this:		Display example ( $z = x^2/2 - y^2/8$ )
Facing the $x$ -axis	Tap [Zoom] and then [View- $x$ ], or press the $\boxed{x}$ key.	
Facing the $y$ -axis	Tap [Zoom] and then [View- $y$ ], or press the $\boxed{y}$ key.	
Facing the $z$ -axis	Tap [Zoom] and then [View- $z$ ], or press the $\boxed{z}$ key.	

• **To initialize the View Window settings**

1. Tap , or tap  and then [View Window] to display the View Window dialog box.
2. On the [Memory] menu select [Initial], or tap the [Default] button.
3. Tap [OK].

**Tip:** You can also initialize the View Window settings by tapping [Zoom] and then [View-Init]. Note, however, that doing so also initializes the zoom setting.

**Showing and Hiding Axes and Labels**

On the 3D Graph window, each tap of  or each press of the  key cycles the display settings of axes and labels in the sequence shown below.

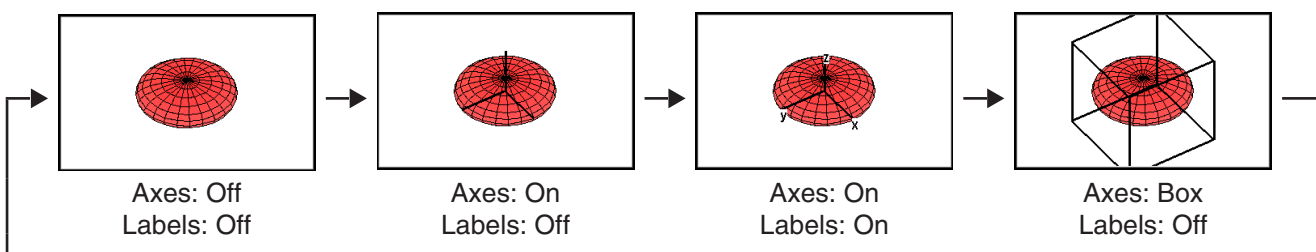

You can configure the initial startup axes and labels display setting (the setting applied each time 3D Graph Application is started up) using the [3D Format] tab of the Graph Format dialog box. For more information, see “Graph Format Dialog Box” on page 38.

---

## Rotating the Graph

A graph can be rotated manually using the touch panel or calculator keys, or it can be rotated automatically.

### • To rotate a graph manually using the stylus

Drag the stylus on the 3D Graph window in the direction you want to rotate the graph.



### • To rotate a graph manually using the cursor keys and graph controller arrows

Press the cursor key that indicates the direction you want to rotate the graph. Or you can tap the graph controller arrow that indicates the direction you want to rotate.

#### Note

- Holding down a cursor key will rotate the graph continuously.
- Display of the graph controller arrows is turned off under initial default settings. Use the “G-Controller” check box on the Graph Format dialog box to turn it on, if you want. For more information, see “Graph Format Dialog Box” on page 38.

### • To rotate a graph automatically

1. To start automatic graph rotation, tap  and then [Rotating].
2. On the submenu that appears, select the rotation direction you want: [Left → Right], [Right → Left], [Top → Bottom], or [Bottom → Top].
  - Rotation continues for about 30 seconds and then stops automatically. You can also stop automatic rotation by pressing the  key or tapping  on the icon panel.

---

## 3D Graph Example

**1401** To graph the hyperbolic paraboloid  $z = \frac{x^2}{2} - \frac{y^2}{8}$

**1402** To graph a parametric equation  $x = 3 \cdot \sin(t) \cdot \cos(s)$ ,  $y = 3 \cdot \cos(t) \cdot \cos(s)$ ,  $z = \sin(s)$

---

## Using Trace to Read Graph Coordinates

Starting the trace operation causes a crosshair pointer to appear on the graph. You can then press a cursor key or tap the graph controller arrows to move the pointer to the location you want, and read the coordinates that appear on the display. To start the trace operation and display the pointer, make the 3D Graph window active, and then tap , or tap [Analysis] and then [Trace].

- Each time you press the cursor key or tap a graph controller arrow, the pointer moves the distance specified by the [grid] value on the 3D View Window dialog box.
- Inputting a value while a trace operation is being performed displays a dialog box for inputting an  $x$ - and  $y$ -value, or an  $s$ - and  $t$ -value. Inputting values for each of the variables on this dialog box causes the pointer to jump to the corresponding location when you tap [OK].

To cancel the trace operation, tap  on the icon panel.

**Tip:** The initial default setting for the coordinate display is rectangular coordinates. With the [3D Format] tab of the Graph Format dialog box, you can specify display of polar coordinates or you can hide coordinates, if you want. For more information, see “Graph Format Dialog Box” on page 38.

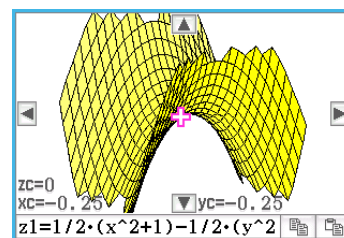

---

## Inserting Text into a 3D Graph Window

You can insert text into a 3D Graph window and delete it as required.

For more information, see “To write text on the Graph window” on page 113, and “To clear figures inserted using the Sketch menu” on page 112.

---

## Calculating a $z$ -value for Particular $x$ - and $y$ -values, or $s$ - and $t$ -values

Use the following procedure to calculate a  $z$ -value for given  $x$ - and  $y$ -values on the displayed graph.

### • ClassPad Operation

1. Draw the graph and make the 3D Graph window active.
2. Tap [Analysis], and then [z-Cal].
3. On the dialog box that appears, enter values for  $x$  and  $y$ , and then tap [OK].
  - The 3D graph window shows  $x$ ,  $y$ , and  $z$  coordinate values, which indicate the current location of the crosshair pointer. The crosshair pointer will not be visible on the graph if it is located outside of the current display area.
  - Inputting a graph value while “z-Cal” is on the display cause a dialog box to appear for specifying an  $x$ - and  $y$ -value, or an  $s$ - and  $t$ -value. You can use this dialog box to specify other  $x$ - and  $y$ -values, or  $s$ - and  $t$ -values.
4. To cancel the  $z$ -Cal operation, tap  $\text{Esc}$  on the icon panel.

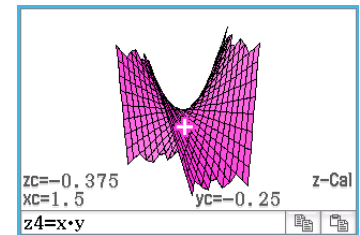



# Chapter 15: Picture Plot Application

Picture Plot is an application that lets you plot points (that represent coordinates) on a photograph, illustration, or other graphic and perform various types of analysis based on the plotted data (coordinate values).

The photograph to the right, for example, shows a uniquely curved bridge.

The plane of the frontmost edge of the bridge is treated as the  $xy$  coordinate plane, and the left side base of the bridge is treated as the origin  $(0, 0)$ . This makes it possible to express any point on along the edge of the bridge floor as a coordinate  $(x, y)$ .

The Picture Plot plot function makes it easy to plot points on a photograph such as this or some other image, and extract the coordinate values of the plots.

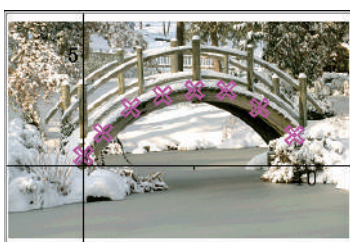

Plotting points

	x	y	t	
1	-0.0110	0.45	0	
2	0.8803	1.5	1	
3	2.118	2.65	2	
4	3.554	3.2	3	
5	4.99	3.45	4	
6	6.426	3.45	5	
7	7.912	2.65	6	
8	9.400	1.5	7	
	-0.01102			✓ X

Coordinates (Plot List window)

You can use the plots to perform the following types of operations.

- Register and graph a  $y = f(x)$  form equation and overlay it on a photograph and plot.
- Perform regression calculation based on the plotted coordinate values and draw a regression graph that overlays the plots. This makes it possible to produce the mathematical expression and graph of a path of movement.
- Add time values ( $t$ ) to the coordinate values ( $x, y$ ) and plot points on the  $t-x$  plane or  $t-y$  plane. This makes it possible to produce the mathematical expressions and graphs of the correlation between horizontal direction movement and time, and the correlation between vertical direction movement and time.



$x$ - $y$  coordinate plot  
regression graph example

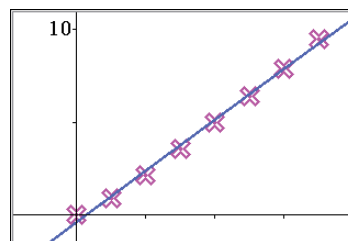









$t$ - $x$  coordinate plot  
regression graph example

---

## Picture Plot Application-Specific Menus and Buttons

### Picture Plot window

- Open the c2p or c2b file..... File - Open
- Save the c2p or c2b file being edited..... File - Save
- Adjust the lightness of an image (page 259)..... File - Fade I/O
- When the currently open image is a c2b file, sequentially display the image in the file..... File - Play
- Display a color setting dialog box for the currently selected plot ..... Edit - Style
- Start editing of plots in the c2b file ..... Edit - Edit Plot (Animation)
- Activate the select function for selecting a plot..... View - Select or 
- Activate the pan function for dragging the Picture Plot window with the stylus ..... View - Pan or 
- Show/hide axes and scale ..... View - Toggle Axes or 
- Display the Graph Editor dialog box ..... Graph - Graph Editor or 
- Display a trace cursor that can be positioned on any  $x, y$  coordinate ..... Graph - Trace or 
- Calculate the root, minimum value, maximum value or  $y$ -axis intercept of the currently selected graph ..... Graph - G-Solve
- Display the  $t$ - $y$  Plot window..... Graph - Transform Axes -  $t$ - $y$  or 
- Display the  $t$ - $x$  Plot window..... Graph - Transform Axes -  $t$ - $x$  or 
- Display/activate the Plot List window ..... 
- Enter the plot mode (for plotting points on the screen) ..... 

### $t$ - $x$ Plot window, $t$ - $y$ Plot window

- Close the  $t$ - $x$  or  $t$ - $y$  Plot window and display the Picture Plot window..... 

### Plot List window

- Clear all current plot data and background images (return all Picture Plot window and Plot List window content to its initial default state)..... File - New
- Open a Spreadsheet file as Plot List data..... File - Open Spreadsheet
- Save Plot List data as a spreadsheet ..... File - Save Spreadsheet
- Import variable data to Plot List window ..... File - Import
- Export Plot List window data to a variable ..... File - Export
- Specify the number format of values on the Plot List window..... Edit - Number Format

### Items common to the Picture Plot window, $t$ - $x$ / $t$ - $y$ Plot window, and Plot List window

- Display the Time Setting dialog box..... Graph - Time Setting
- Display a submenu (same as the one on page 242) for executing regression calculation based on plots. .... Graph - Regression
- Show/hide the regression calculation result dialog box ..... Graph - Disp Stat

## 15-1 Using the Plot Function

You can plot points on the screen, overlay them with a graph of an expression in the form  $y = f(x)$ , and draw a regression graph that approximates the plots.

---

### Starting a Picture Plot Operation

The Picture Plot application lets you use a still image (c2p file) or animation (c2b file) that contains a mathematical meaningful object or scene as a background, and plot points on the background image. Because of this, a Picture Plot operation always starts with opening of a background file.

**Tip:** c2p and c2b are special ClassPad file formats. You can use files that come preloaded on your ClassPad, or you can obtain files from the CASIO support site ([edu.casio.com](http://edu.casio.com)).



#### • To open a c2p or c2b file for use as the Picture Plot window background

1. On the application menu, tap  to start the Picture Plot application.
  - This will display a full-screen view of the Picture Plot window.
2. Tap [File] - [Open].
  - This displays the file list screen.
3. Select the c2p or c2b file you want to open and then tap [Open].
  - The file will open and its content will appear as the Picture Plot window background image.

What you should do next depends on the file type.

- c2p file: "Plotting Points on a c2p File Image" (page 259)
- c2b file: "Plotting Points on a c2b File Image" (page 260)

#### • To adjust the lightness (Fade I/O) of an image



1. While the Picture Plot screen is displayed, tap [File] and then [Fade I/O].
  - This causes a slider for adjusting image lightness to appear on the toolbar.
2. Tap  or  on the toolbar to adjust the lightness value.
3. After the setting is the way you want, tap the [OK] button on the toolbar.

---

### Plotting Points on a c2p File Image

This section explains how to plot points on a c2p file (still image) background.

#### • To plot points on a c2p file image

1. Open the c2p file whose image you want to use as the Picture Plot window background.
2. Tap  to enter the Plot mode.
3. Use the stylus to tap the points you want to plot.
  - A plot point appears at each location you tap.
  - To undo the last point you plotted, tap [Edit] - [Undo/Redo].
4. Repeat step 3 as many times as required to plot all of the points you want.
  - You can plot up to 50 points per background image.
5. To exit the Plot mode, tap .
6. To save the plot data to the c2p file, tap [File] - [Save].

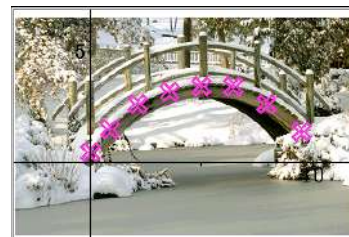

7. On the dialog box that appears, perform the required operation to save the file.
  - For details about the information saved to a file, see “15-4 Picture Plot Application Files”.

Next, perform the operations below.  
 “Editing Plots on a Background Image” (page 261), “Overlaying a Graph on Background Image Plots” (page 261).

## Plotting Points on a c2b File Image

This section explains how to plot points on a c2b file (animation image) background. The maximum number of plots allowed in a background animation (c2b) image is the same as the number of still images that make up the animation file.

### • To plot points on a c2b file image

1. Open the c2b file whose image you want to use as the Picture Plot window background.
  - This displays the first of the still images that make up the c2b file.
2. Tap  to enter the Plot mode.
3. Use the stylus to tap the point you want to plot.
  - This will display a plot point at the location you tap and advance to the next of the still images that make up the c2b file.

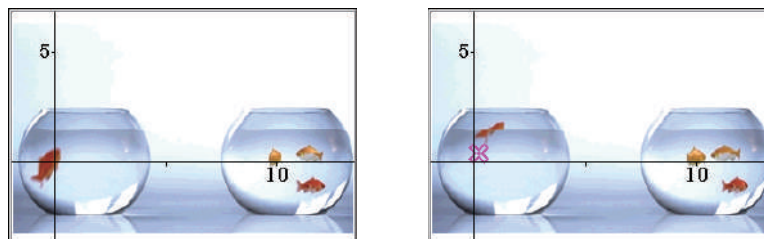

- To undo the last point you plotted, tap [Edit] - [Undo/Redo].
4. Repeat step 3 as many times as required to plot all of the points you want.

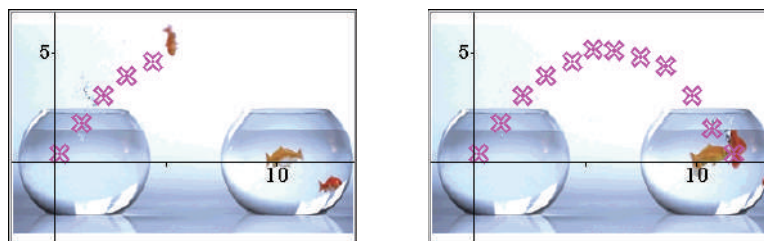

- Plotting a point on the last still image of the c2b file will cause the “Plotting is finished.” dialog box to appear. On the dialog box, tap [OK] to exit the Plot mode.
  - To exit the Plot mode before displaying the final image of a c2b file, tap .
5. To save the plot data to a c2b file, tap [File] - [Save].
  6. On the dialog box that appears, perform the required operation to save the file.
    - For details about the information saved to a file, see “15-4 Picture Plot Application Files” (page 266).

Next, perform the operations below.  
 “Editing Plots on a Background Image” (page 261), “Overlaying a Graph on Background Image Plots” (page 261).

- **To view the images that make up a c2b file**

1. With the c2b file whose images you want to view displayed as the background image of the Picture Plot window, tap [File] - [Play] - [Auto] or [File] - [Play] - [Manual].
2. To exit this operation, tap  on the toolbar.

---



## Editing Plots on a Background Image

You can use the procedures in this section to reposition individual plot points. You can also change the color of all the plots or delete all the plots from an image.

- **To reposition a point plotted on a c2p background image**

1. On the Picture Plot window, tap  or [View] - [Select].
2. Use the stylus to tap the plot point you want to reposition and then drag it to the location you want.

- **To reposition a point plotted on a c2b background image**

1. On the Picture Plot window, tap [Edit] - [Edit Plot (Animation)].
  - This enters the Edit plot mode and displays a full-screen view of the Picture Plot window.
2. On the toolbar, tap  or  to display the c2b image whose plot point you want to reposition.
3. Use the stylus to tap the plot point and then drag it to the location you want.
4. Repeat steps 2 and 3 for other plot points, if you want.
5. To exit the Edit plot mode, tap .

- **To change the color of all points plotted on a c2p or c2b background image**

1. c2p file image: On the Picture Plot window, tap  or [View] - [Select].  
c2b file image: On the Picture Plot window, tap [Edit] - [Edit Plot (Animation)].
2. Tap any one of the plot points so it is selected, and then tap [Edit] - [Style].
3. On the dialog box that appears, select the color you want and then tap [OK].

- **To delete all plots and graphs from a background image**

1. On the Picture Plot window, tap [Edit] - [Clear All].
2. On the confirmation dialog box that appears, tap [OK].

---

## Overlaying a Graph on Background Image Plots

You can use the procedures in this section to overlay a graph on points you plotted on the Picture Plot window background image.

- **To input an expression of the form  $y = f(x)$  and graph it**

1. On the Picture Plot window, tap [Graph] - [Graph Editor].
    - This displays the Graph Editor dialog box.
  2. Input a function of  $x$  (such as:  $-x^2 + 2$ ) and then press .
  - This will register the function and move the cursor to the next line. You can repeat step 2 above to register another function, if you want.
  - You can register up to five functions.
3. Select the check boxes of the registered expressions you want to graph, and clear the check boxes of expressions you do not want to graph.

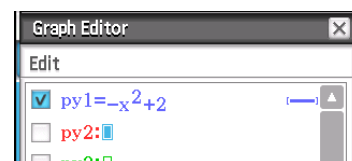

4. To graph, tap [Draw].

- This closes the dialog box and draws the graph(s) on the Picture Plot window.

**Tip:** Expressions registered on the Graph Editor dialog box above can be recalled from and graphed with the Graph & Table application, by performing the steps below.

- (1) On the Graph & Table Graph Editor window, input the line name (*py1* through *py5*) of the expression you want to recall and then input “(x)” to the right of the name.
- (2) Press **[EXE]**.
- (3) To draw the graph, tap **[Ψ]**.

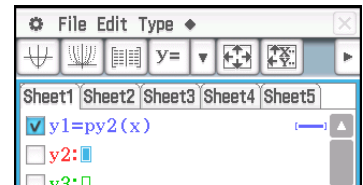

### • To use Dynamic Graph to change the parameter values of a Picture Plot window graph

1. On the Picture Plot window, tap [Graph] - [Graph Editor].

- This displays the Graph Editor dialog box.

2. Use the soft keyboard to input a function of  $x$  (such as:  $y = a \cdot x^2 - b \cdot x$ ) that includes at least one parameter, and then press **[EXE]**.

3. Select the check boxes of the functions you want to graph, and clear the check boxes of the functions you do not want to graph.

4. To graph, tap [Dynamic].

- This will display sliders for changing values assigned to parameters  $a$  and  $b$ , and will also draw a graph based on an initial value of 1 assigned to  $a$  and  $b$ .
- Use the sliders to change the values of the graph expression parameters and dynamically modify the form of the graph accordingly. For details about this operation, see step 4 under “To run Dynamic Modify” (page 116).

5. To exit the Dynamic Modify operation, tap the close button (**[X]**) in the upper right corner of the slider display box.

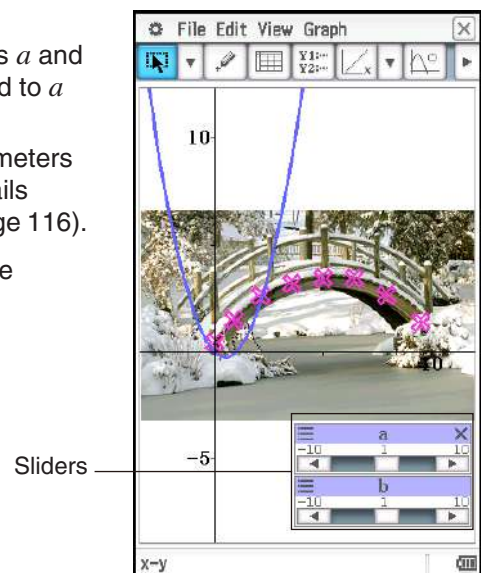

**Tip:** In place of the soft keyboard in step 2 of the above procedure, you can also tap [Edit] - [Built-In(1)] or [Built-In(2)], and then use the sub-menu of built-in functions that appears to input a function.

### • To overlay a regression graph on plotted points

1. On the Picture Plot window, tap [Graph] - [Regression].

- This displays the regression calculation type sub menu.

2. Tap the menu item that corresponds to the type of regression calculation\*1 you want to perform.

- To perform quadratic regression, for example, tap [Quadratic Reg]. This will perform regression calculations and display a Stat Calculation dialog box\*2 of calculation results like the one shown nearby.

3. If you want to register the calculation result regression formula to the Picture Plot application’s Graph Editor, perform the steps below.

(1) Tap the down arrow button (**[▽]**) on the right side of the “Copy Formula” box.

(2) On the list that appears, select regression formula registration destination (*py1* through *py5*).

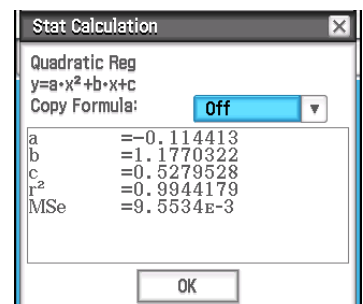

4. Tap [OK].

- This will graph the regression formula of the calculation results.

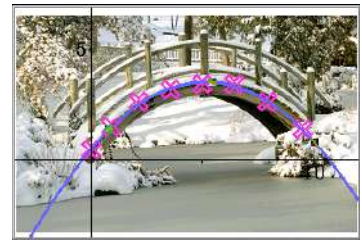

\*1 For information about regression calculation types, see “Regression types” (page 138).

\*2 This dialog box will appear when there is a check mark next to [DispStat] on the [Graph] menu. This menu item has a check mark next to it under initial default settings.

For information about the meanings of the values that appear on this dialog box, see “To view regression calculation results” (page 143).

### • To delete one of the graphs draw on the Picture Plot window

1. On the Picture Plot window, tap or View - Select.

2. Tap the graph you want to delete.

- This will cause handles (■) to appear on the graph you tap to indicate that it is selected.

3. Tap [Edit] - [Delete].

### • To view the coordinates of a specific location on a graph (Trace)

1. Tap [Graph] - [Trace] or .

- This will display in the center of the Picture Plot window.

2. You can move by tapping the location to which you want to move it.

- The coordinates at the current position of will be shown in the status bar.

- To exit the Trace operation, press Clear.

---

## G-Solve

You can use the G-Solve function to calculate the root, min, max, and y-intercept of the graph that is currently selected on the Picture Plot window. Picture Plot window G-Solve operations are the same as those with the Graph & Table application. For more information, see “3-6 Analyzing a Function Used to Draw a Graph”.

---

## Scrolling the Picture Plot Window

On the Picture Plot window, you can use the cursor keys to scroll the XY-coordinate axes up, down, left, and right. Note that the background image is fixed and does not scroll.



You also can tap View - Pan or and pan (grab-and-drag) the XY-coordinate axes.

## 15-2 Using the Plot List



Each plot on the Picture Plot window has coordinate value data. You can use the Plot List window to display and edit these coordinates.

---

### Using the Plot List Window to Edit Plots

You can use the Plot List window to edit the coordinate values of previously plotted points and plot new points by inputting coordinate values. You can also delete all of the plot data from an image.

#### • To edit plot coordinate values

1. While the Picture Plot window is displayed, tap .
  - This will display the Plot List window in the lower half of the screen.
  - The  $x$  and  $y$  values of the Plot List window show plot coordinates. The  $t$  value indicates time. (For more information about  $t$  values, see “15-3 Displaying Plots on  $t$ - $y$  or  $t$ - $x$  Coordinates”.) On this window you can edit the  $x$  and  $y$  values only.
2. Tap a cell and then edit its contents.
  - To edit cell contents, use the same operations as those for the Spreadsheet application. See “13-1 Inputting and Editing Cell Contents” for more information.
  - The maximum allowable number of editing/input rows is 50 when the background image is a c2p file. For a c2b file background image, the maximum number of rows is the same as the number of still images that make up the animation file.
  - Any change you make to a value will be reflected by the corresponding plot on the Picture Plot window. Inputting an  $x$ -value and  $y$ -value in a row that is blank will plot a new point at the applicable coordinates.
3. To save edited plot data to the c2p or c2b file, tap [File] - [Save].
  - This displays a dialog box. The current name of the file you are editing will appear by default in the file name input box.
4. To overwrite the current file with the edited version, tap [Save]. On the “Overwrite?” dialog box that appears, tap [OK] to save the file. To assign a different name to the edited version of the file, change the name in input box and then tap [Save].
  - You can also save the file after returning to the Picture Plot window, if you want.
  - For details about the information saved to a file, see “15-4 Picture Plot Application Files”.
5. To exit editing and return to the Picture Plot window, tap  or the Picture Plot window.
  - Note that the Plot List window cannot be closed while the Picture Plot application is running. To hide the Plot List window and display a full-screen view of the Picture Plot window, make the Picture Plot window active and then tap .

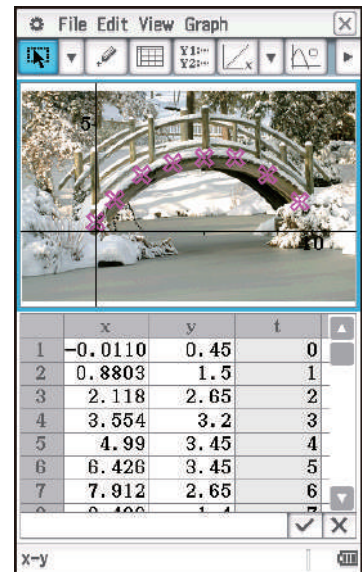

---

### Saving Data to and Importing Data from a Spreadsheet

You can save coordinate data ( $x$ -column and  $y$ -column data), including the cell format information (number format, text color, fill color), that is plotted on the Plot List window as a spreadsheet.

You can also import A-column and B-column data from a spreadsheet created with the Spreadsheet application to the  $x$ -column and  $y$ -column of the Plot List window. Cell format information that is supported by the Plot List window is also imported.



- **To save plot coordinate data as a spreadsheet**

1. On the Plot List window, tap [File] - [Save Spreadsheet].
2. On the dialog box that appears, specify the file save destination folder and input a file name.
3. Tap [Save].

- **To import a spreadsheet as plot coordinate data**

1. On the Plot List window, tap [File] - [Open Spreadsheet].
2. On the dialog box that appears, select the spreadsheet you want to import and then tap [Open].

**Note:** If the number of rows of spreadsheet you selected in step 2 of the above procedure exceeds the allowable maximum (50 for a c2p file, equal to the number of still images for a c2b file), rows are imported only up to the allowable maximum. Any spreadsheet data from Column C onwards and format information that is not supported by the Plot List window is ignored.

---

## Exporting Plot Data to and Importing Plot Data from a Variable

You can import LIST (list), MAT (matrix), and EXPR (expression) variables into the Plot List window. Data inside of cells selected on the Plot List window can be exported as at LIST, MAT, or EXPR variable. The steps of these operations are the same as those for the Spreadsheet application. For more information, see “Importing and Exporting Variable Values” (page 235).

## 15-3 Displaying Plots on $t$ - $y$ or $t$ - $x$ Coordinates

As can be seen on the Plot List window, the data for each plot includes  $x$ - and  $y$ -coordinates, as well as a time value  $t$ . On the Picture Plot screen each plot is normally displayed as coordinates  $(x, y)$  on an  $x$ - $y$  plane, but time value  $t$  can be used to display plots as coordinates  $(t, y)$  on a  $t$ - $y$  plane or as coordinates  $(t, x)$  on a  $t$ - $x$  plane.

Under initial default settings, time values are 0, 1, 2, and so on (arithmetic progression with a start value of 0 and a step value of 1), in accordance with the sequence that the points are plotted. You can change the  $t$  value assigned to each plot by changing the start value and step value.

- **To configure the time ( $t$ ) value**

1. On any Picture Plot application window, tap [Graph] - [Time Setting].
2. On the dialog box that appears, specify the start value and step value.
3. After the settings are the way you want, tap [OK].

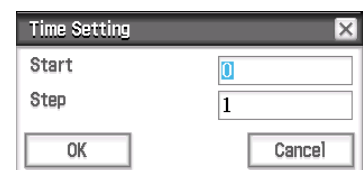

• To display plots on  $t$ - $y$  coordinates or  $t$ - $x$  coordinates

To display plots on  $t$ - $y$  coordinates, tap [Graph] - [Transform Axes] - [ $t$ - $y$ ] or tap  $\rightarrow t-y$ .

To display plots on  $t$ - $x$  coordinates, tap [Graph] - [Transform Axes] - [ $t$ - $x$ ] or tap  $\rightarrow t-x$ .

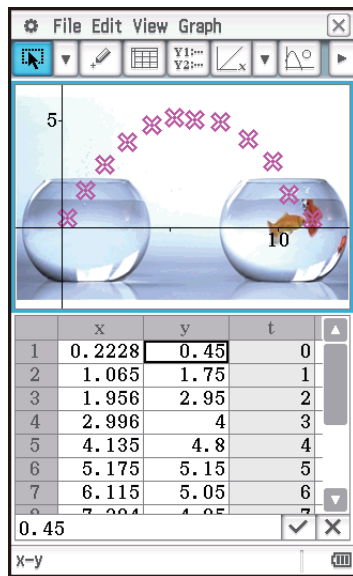

Picture Plot window  
( $x$ - $y$  coordinates)

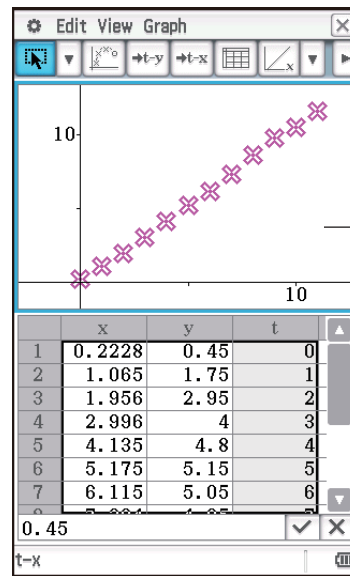

$t$ - $x$  Plot window  
( $t$ - $x$  coordinates)

**Tip:** You can tell which window (Picture Plot,  $t$ - $y$  Plot, or  $t$ - $x$  Plot) is displayed by checking the status bar.

## 15-4 Picture Plot Application Files

The Picture Plot application can be used to write plot data and/or various types of setting data directly into a c2p or c2b file that is opened as a background image. The data and setting information that can be written to a c2p or c2b file by the Picture Plot application is shown below.

- Plot data
- Color setting of each plot
- Number format, text color, and fill color of each cell on the Plot List window
- Time setting (start value and step value)
- Axes/Grid settings
- Graph expressions ( $py1$  through  $py5$ ) that are registered on the Graph Editor dialog box
- Fade I/O setting
- View Window settings

# Chapter 16: Interactive Differential Calculus Application

The Interactive Differential Calculus Application helps you learn about differential coefficients and/or derivative formulas that are the foundation of differentiation.

It has a DiffCalc Table window (①) and a DiffCalc Graph window (②), and the DiffCalc Table window has four tabs, described below.

[Function] tab: For input of  $y = f(x)$  functions used for differentiation. The purpose of this tab is function input only, so the DiffCalc Graph window is not displayed while this tab is displayed.

[Tangent] tab: This tab makes it possible to observe the slope of a straight line passing through two points (D and E) on the function  $y = f(x)$  getting closer to the slope of a tangent to point E as point D approaches point E. This helps to demonstrate the fundamentals of differentiation.

[Deriv] tab: When the points  $(x_1, y_1), (x_2, y_2), \dots (x_n, y_n)$  on the function  $y = f(x)$  have tangents with the slopes  $slope_1, slope_2, \dots slope_n$ , the [Deriv] tab can be used to plot the coordinates  $(x_1, slope_1), (x_2, slope_2), \dots (x_n, slope_n)$  on the graph screen. After plotting a number of points, use the function indicated by their loci to study the function indicated by them, and consider what is the derivative (what expression is indicated by the function) of  $y = f(x)$ .

[D Trace] tab: Displaying this tab causes  $x, f(x), f'(x)$  number tables to be generated automatically based on the  $f(x)$  function input on the [Function] tab. Selecting a different  $x$ -value provides a visual understanding of how the  $f(x)$  value, tangent,  $f'(x)$  value, and  $f''(x)$  value change accordingly. At the same time,  $y = f(x)$  and  $y = f'(x)$  are graphed, and a tangent to the  $y = f(x)$   $x$ -value are also drawn automatically.

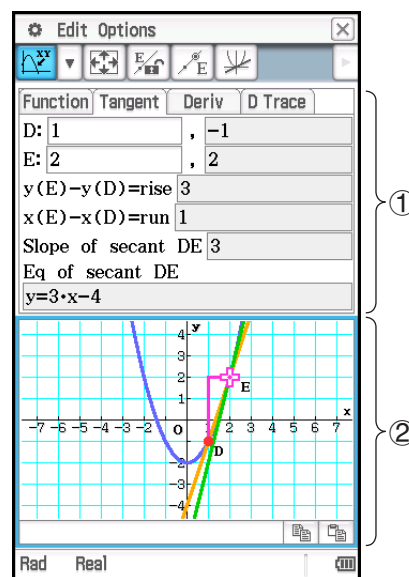

## DiffCalc Table Window-Specific Menus and Buttons

### [Tangent] tab only

- Enable point E movement.....Options - Move Point E or
- Lock point E .....Options - Fix Point E or
- Switch between the point (D or E) that moves when you press the left or right cursor key ..... /
- Show the line tangent to point E ..... Options - Show Tangent or
- Hide the line tangent to point E..... Options - Hide Tangent or

### [Deriv] tab only

- Delete the currently selected line in a number table ..... Edit - Delete
- Manually input a derivative predicted function and draw a graph.....Calc - Predicted Function - Editor or
- Clear the predicted function .....Calc - Predicted Function - Clear
- Determine regression from plots obtained from a number table and draw a graph  
.....Calc - Regression Function - Linear Reg () / Quadratic Reg () /  
Cubic Reg () / Sinusoidal Reg ()
- Clear the regression function .....Calc - Regression Function - Clear

### [D Trace] tab only

- Display the Table Input dialog box for configuring  $x$ -value step setting .....
- Switch a number table between three value type combinations  
( $x, y_1, y_2; x, y_2, y_3; x, y_1, y_2, y_3$ ) .....

## 16-1 Learning about Tangents Using the [Tangent] Tab

Consider the slope (differential coefficient) of a tangent to a point on a curve represented by  $y = f(x)$ . Two points (D and E) are placed on the graph of  $y = f(x)$ , and a straight line (DE) through the two points and the tangent of point E are drawn. As point D moves infinitely closer to point E, line DE moves infinitely closer to the tangent of point E. This derives the slope of the line tangent to point E.

### • To use the [Tangent] tab

Example: On the graph of  $y = x^2 - 2$ , derive the slope of the line tangent to a point (2, 2) on the graph of  $y = x^2 - 2$ .

1. On the application menu, tap  to start the Interactive Differential Calculus application.
2. On the [Function] tab that appears, input  $x^2 - 2$  into the “y:” line under “Function”.

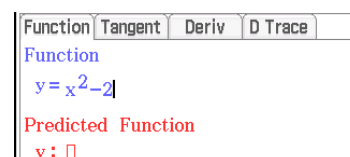

3. Tap the [Tangent] tab.

- This will cause the display to appear as shown below.

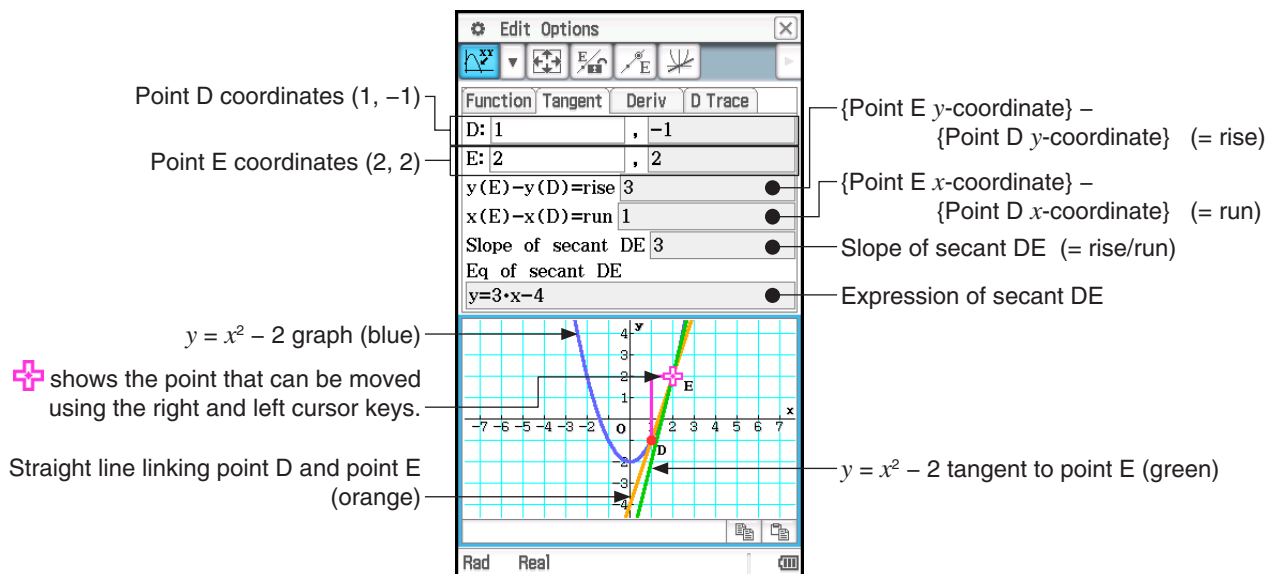

4. Tap  (or Point - Fix Point E).



- This locks point E and allows relocation of point D only.

5. Use the left and right cursor keys to move point D on the  $y = x^2 - 2$  graph closer and closer to point E.

6. Move point D to the same location as point E.

- This will cause the rise and run values on the [Tangent] tab to become 0, and only the  $y = x^2 - 2$  (green) tangent of point E (which is the same as point D) will remain displayed.
- Use the cursor keys to move point D and observe the Slope of secant DE and Eq (equation) of secant DE immediately before and after the location where point D and point E are identical. This way you can study the slope and expression of tangent  $y = x^2 - 2$ .

### Note

- To switch between the point (D or E) that moves when you press the left or right cursor key, press the up or down cursor key, or tap  or . The point that will be moved when you press the left or right cursor key is indicated by .
- You can also move the point E or point D using the stylus. Tap and hold one of the points with the stylus, and then drag to the location to which you want to move it.

## 16-2 Deriving the Derivative Using the [Deriv] Tab

### • To use the [Deriv] tab

Example: The slope of a tangent at a point  $(x, y)$  on the graph of  $y = x^3 - 4x$ , is *slope*. Plot coordinates  $(x_1, slope_1)$ ,  $(x_2, slope_2)$ ,  $(x_3, slope_3)$ , ...  $(x_n, slope_n)$  on the DiffCalc Graph window, and predict the function that passes through all of the plots. Also, use regression to confirm the function.

1. On the DiffCalc Table window, display the [Function] tab.
2. In the “y:” line under “Function”, input  $x^3 - 4x$ .
3. Tap the [Deriv] tab.
  - This will cause the display to appear as shown below.

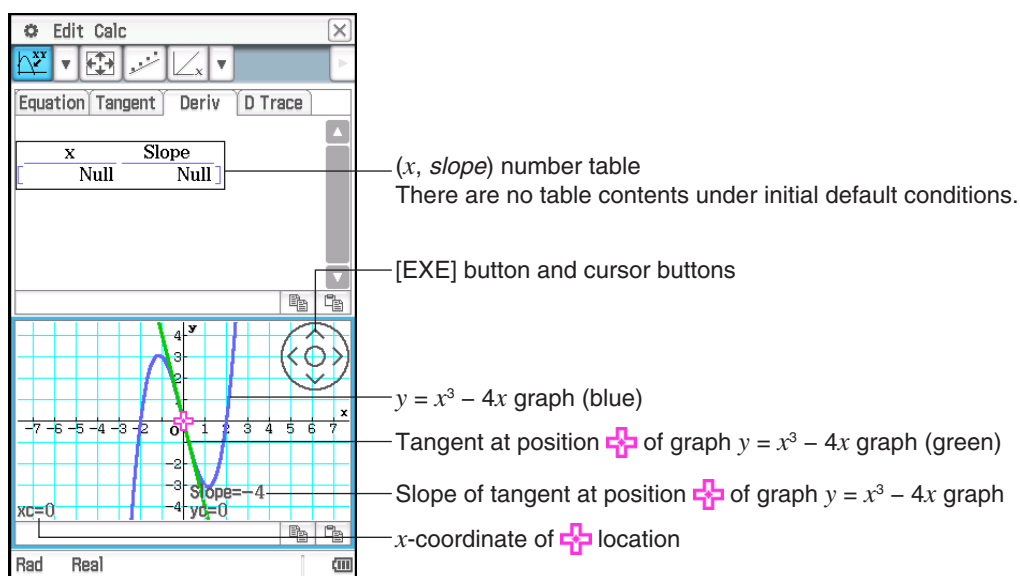

4. On the DiffCalc Graph window, plot a point at coordinates  $(x, slope)$ .
  - (1) Use the cursor buttons to move  $\oplus$  around the graph.
  - (2) Tap the [EXE] button.
    - This will add the  $x$  and slope values at the current location of  $\oplus$  to the number table on the [Deriv] tab. At the same time, the  $(x, slope)$  will be plotted on the DiffCalc Graph window.
  - (3) Repeat steps (1) and (2) above to plot at least four points.
    - At this point, try to predict the expression ( $y = f(x)$  function) that will produce a curve that passes through all of the plots.

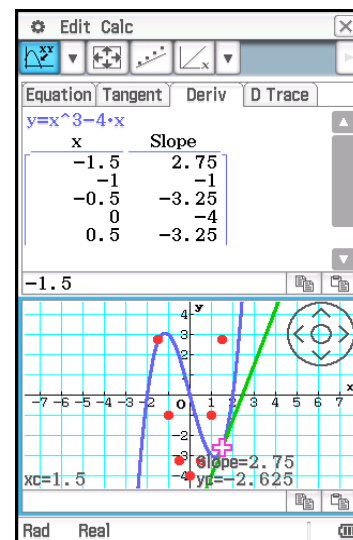

5. Input the expression and graph it.
  - In this example, we can predict a quadratic function curve, so we will try inputting  $y = 2x^2 - 4$ .
  - (1) Tap Calc - Predicted Function - Editor or

(2) On the dialog box that appears, input  $2x^2 - 4$  and then tap [OK].

- This will graph the expression you input.

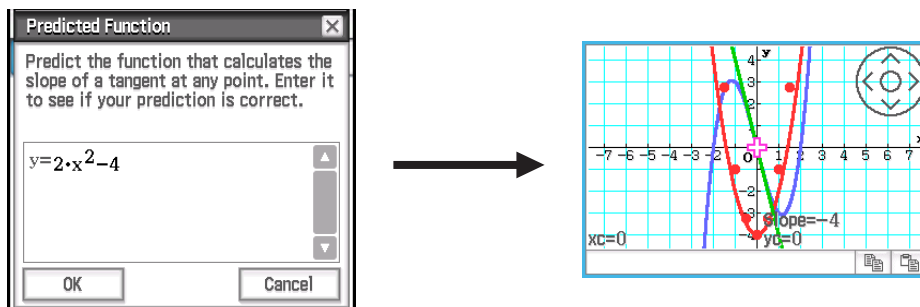

6. Perform regression to check if the function you predicted is correct.

Since we predicted a quadratic function curve here, we will perform quadratic regression.

Tap Calc - Regression - Quadratic Reg or .

- This draws the graph based on the calculation results.

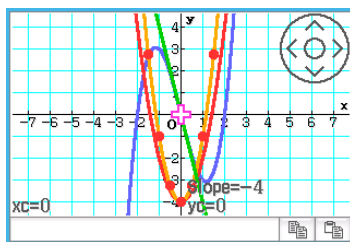

**Tip:** There are four types of regression available on the Calc - Regression menu. Decide on the type of regression calculation you want to perform based on the straight lines and curves expected from the shape of the plots.

### Note

- In step 4 of the above procedure, be sure to plot at least four points for the  $(x, slope)$  coordinates. When there are fewer than four plots, attempting to perform the steps from step 5 onward will cause the message “Plot at least 4 points.” to appear to let you know you cannot go any further until you plot more points.
- The predicted expression you input in step 5 and the regression expression obtained in step 6 automatically overwrite the applicable fields on the [Function] tab.
- For details about the regression calculation result dialog box that appears in step 6-(2) above, see the table in step 3 of the procedure under “To view regression calculation results” (page 143).

## 16-3 Generating a Number Table and Graphing the First Derivative and Second Derivative Using the [D Trace] Tab

The [D Trace] tab can simultaneously handle the three types of functions below, which are based on the functions input for “Function” on the [Function] tab.

- $x$  function  $y1$  ( $= f(x)$ )
- $y1$  first derivative  $y2 = y1'$  ( $= f'(x)$ )
- $y1$  second derivative  $y3 = y1''$  ( $= f''(x)$ )

You can use this tab to view the number table of  $y1$ ,  $y2$ , and  $y3$  values for each  $x$  value, and to check the graph associated with the number table.\*

\* Defaults:  $x$ ,  $y1$ ,  $y2$

### • To use the [D Trace] tab

Example: Simultaneously graph the function  $y1 = 1/3 \cdot x^3 - 3x$  and its first derivative  $y2 = y1'$ , and compare the graphs. Also, use the graph and number table to observe changes in each of the graph's  $y$ -values ( $y1$ ,  $y2$ ), and study the relationship between the functions.

1. On the DiffCalc Table window, display the [Function] tab.
2. In the “y:” line under “Function”, input  $1/3 \cdot x^3 - 3x$ .
3. Tap the [D Trace] tab.
  - This will cause the display to appear as shown below.

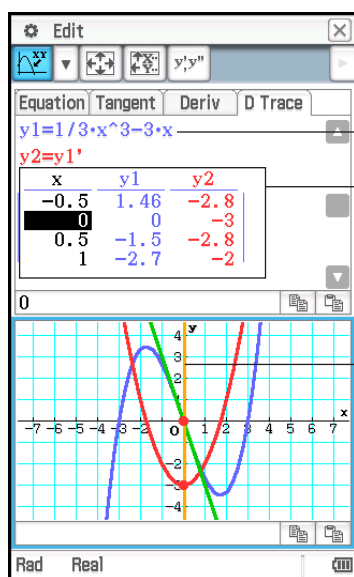

The function you input in step 2 above.

( $x$ ,  $y1$ ,  $y2$ ) number table

$y1$  is the value of  $y1$  for each  $x$  (value of  $f(x)$ ), and  $y2$  is the value of  $y1'$  for each  $x$  (value of  $f'(x)$ ). The colors of the  $y1$ ,  $y2$  text correspond to the colors of the graph lines.

Use the left and right cursor keys to move the vertical line left and right. This will also cause the following items to move accordingly: the point where the vertical line intersects with  $y1$  and  $y2$  (both indicated by red dots), and the tangent (green) of the  $y1$  graph where the vertical line intersects with  $y1$ .

4. Use the cursor keys to move the vertical line, and observe how the  $y_1$  and  $y_2$  values change.

- Compare  $y_1$  and  $y_2$ . You should also observe the green tangent ( $y_1$  tangent) at this time.

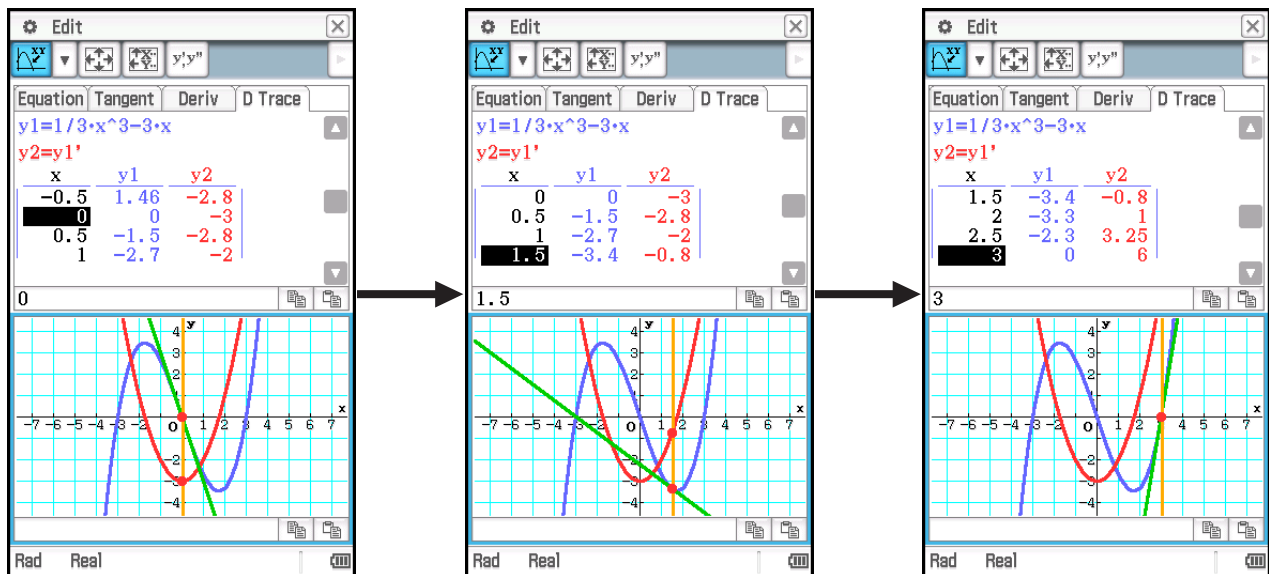

- The current location of the vertical line ( $x$  value) corresponds to the highlighted cell in the  $x$ -column of the number table.
- You can also move the vertical line by dragging it with the stylus.

**• To change the group of items displayed in the number table**

Tap  $y_1, y_2$  to cycle through the settings shown below.

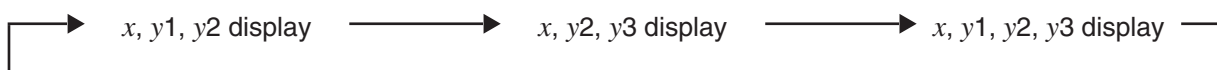

Changing the items of the number table will also change the graph drawn on the DiffCalc Graph window.



# Chapter 17: Physium Application

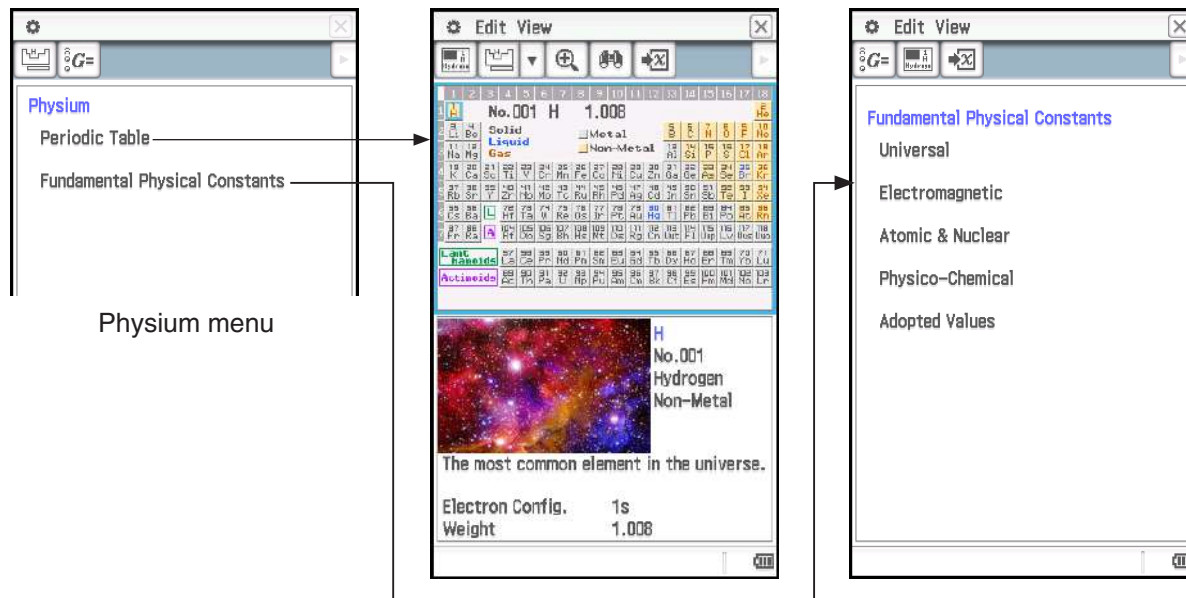

The Physium application includes a built-in periodic table and fundamental physical constants. You can access these from the Physium menu that appears when you start up the application.









- After displaying the periodic table from the Physium menu, you can look up the following information: atomic number of elements, chemical symbols of elements, atomic weights, and electron configurations.
- When you select “Fundamental Physical Constants” on the Physium menu, a list of categories will appear. Select the category whose constants you want to view.
- The periodic table and fundamental physical constants displayed by Physium can be assigned to variables for use in calculations in the Main application, eActivity application, and other applications.

## Physium Application Menus and Buttons



### Physium window (Physium menu)

- Display the Periodic Table window ..... 
- Display the Physical Constants window ..... 

### Periodic Table window



- Assign the atomic weight currently selected on the periodic table to a variable ..... Edit - Store or 
- Zoom the periodic table display ..... View - Large or 
- Return a zoomed view of the periodic table to its normal size ..... View - Normal or 
- Enclose a particular element group in the periodic table with a blue boundary ..... View - Select Series
- Delete a blue boundary you displayed on the periodic table ..... View - Deselect Series or 
- Display a list view of elements ..... View - Search or 
- Make the Periodic Table Detail window active ..... 

### Periodic Table Detail window

- Make the Periodic Table window active ..... 
- Scroll back or forward through atomic numbers ..... 



- Assign the atomic weight of the displayed atom to a variable .....Edit - Store or 

### Physical Constants window

- Return to the Fundamental Physical Constants category menu ..... View - Top or 
- Display details of the currently highlighted physical constant ..... 
- Assign the current physical constant to a variable .....Edit - Store or 
- Display a list of universal physical constants. .... View - Universal
- Display a list of electromagnetic constants ..... View - Electromagnetic
- Display a list of atomic and nuclear constants ..... View - Atomic & Nuclear
- Display a list of physico-chemical constants ..... View - Physico-Chemical
- Display a list of adopted values ..... View - Adopted Values

## 17-1 Periodic Table

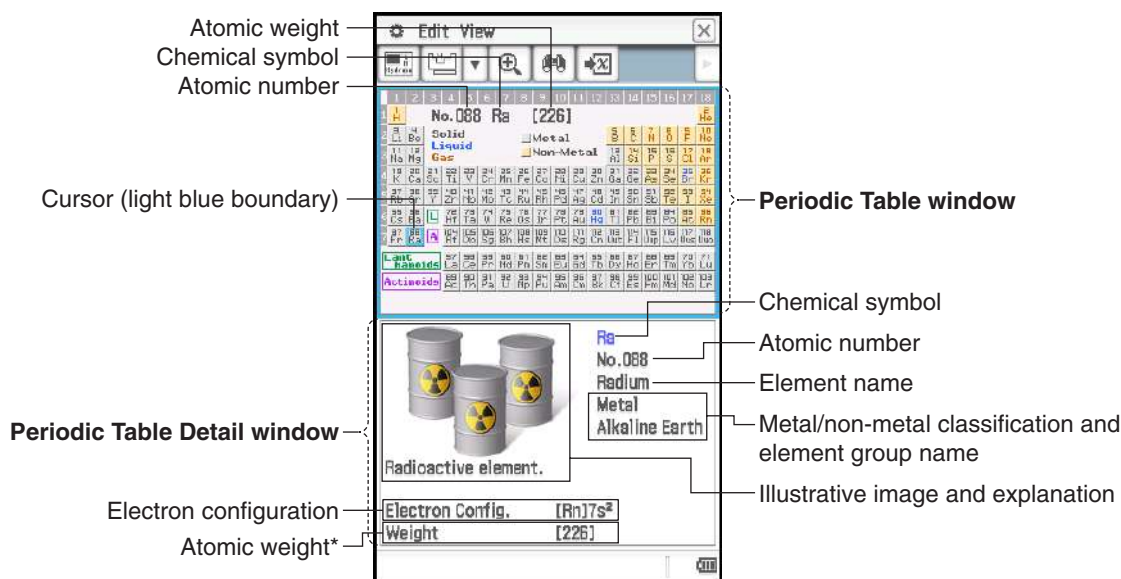

### • To display the periodic table

1. On the application menu, tap  to start the Physium application.
  - This will display the Physium menu.
2. Tap “Periodic Table” or .
  - The upper half of the display shows the Periodic Table window, while the lower half shows the Periodic Table Detail window. Details about the content of each of the windows are shown below.



\* An atomic weight value in square brackets ([ ]) indicates the atomic weight of the most well-known element among isotopes.





### • To enclose a particular element group in the periodic table with the blue boundary

Tap View - Select Series. On the sub-menu that appears select the name of an element group (such as Rare Earth), or tap the down arrow () on the toolbar and then select an element group button (such as .

To clear a blue boundary displayed with this operation, tap View - Deselect Series or .

• **To use the element list to search for an element**

1. On the Periodic Table window, tap .
  - This displays a search dialog box that lists elements, like the one shown in the screenshot nearby.
2. You can use the toolbar buttons shown in the table below to change the sort sequence of the list, if you want.

To sort in this sequence:	Tap this toolbar button:
Atomic number ascending	
Chemical symbol alphabetic	
Element name alphabetic	
Atomic weight ascending	

3. On the element list, tap the element you want to select so it is highlighted.
4. Tap [OK].
  - This closes the Search dialog box and displays the periodic table with the cursor (blue boundary) located at the element you tapped in step 3.

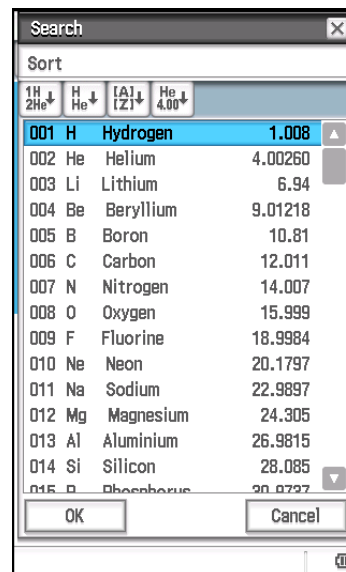

• **To assign an atomic weight to a variable**

1. On the periodic table tap the element whose atomic weight you want to assign to the variable so the blue boundary (cursor) is located there.
  - You can also select an element using the element list as described under “To use the element list to search for an element”.
2. Tap Edit - Store or .
3. On the dialog box that appears, enter the name of the variable you want to use and then tap [OK].
  - This assigns the atomic weight of the element you selected in step 1 of this procedure to the variable whose name you input above.

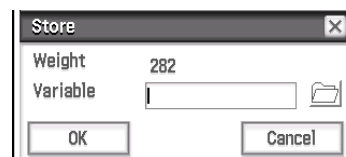



• **To return to the Physium menu**

On the menu bar, tap .

## 17-2 Fundamental Physical Constants

• **To display the Fundamental Physical Constants category menu**

1. On the application menu, tap  to start the Physium application.
  - This will display the Physium menu.
2. Tap “Fundamental Physical Constants” or .
  - This displays the Fundamental Physical Constants category menu.

• **To display a physical constant**

On the Fundamental Physical Constants category menu, tap the name of the category that contains the constant you want to display. You can also select the physical constant category name you want (such as Electromagnetic) on the View menu.

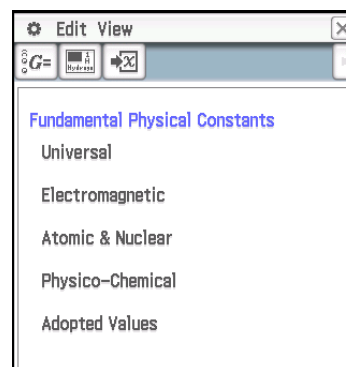

• **To display detailed information about a physical constant**

1. Tap the physical constant value whose information you want to view so it is highlighted.
2. Tap .

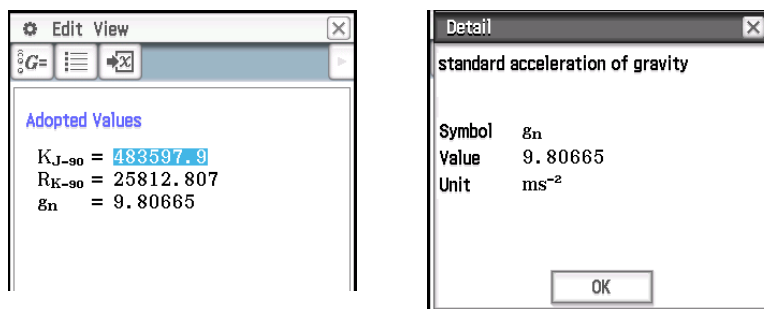

• **To assign a physical constant to a variable**

1. Tap the physical constant value you want to assign to the variable so it is highlighted.
2. Tap Edit - Store or .
3. On the dialog box that appears, enter a variable name and then tap [OK].
  - This assigns the physical constant you selected in step 1 of this procedure to the variable whose name you input above.



• **To return to the Physium menu**

On the menu bar, tap .

**List of Built-in Constants**

**Universal**

- c: speed of light in vacuum
- $\mu_0$ : magnetic constant
- $\epsilon_0$ : electric constant
- $Z_0$ : characteristic impedance of vacuum
- G: Newtonian constant of gravitation
- h: Planck constant
- $\hbar$ : Planck constant over  $2\pi$
- $m_p$ : Planck mass
- $l_p$ : Planck length
- $t_p$ : Planck time

**Electromagnetic**

- $e$ : elementary charge
- $\phi_0$ : magnetic flux quantum
- $G_0$ : conductance quantum

- $K_J$ : Josephson constant
- $R_K$ : von Klitzing constant
- $\mu_B$ : Bohr magneton
- $\mu_N$ : nuclear magneton

**Atomic & Nuclear**

- $\alpha$ : fine-structure constant
- $R_\infty$ : Rydberg constant
- $a_0$ : Bohr radius
- $m_e$ : electron mass
- $\mu_e$ : electron magnetic moment
- $m_\mu$ : muon mass
- $\mu_\mu$ : muon magnetic moment
- $m_\tau$ : tau mass
- $m_p$ : proton mass
- $\mu_p$ : proton magnetic moment
- $m_n$ : neutron mass
- $\mu_n$ : neutron magnetic moment

**Physico-Chemical**

- $N_A$ : Avogadro constant
- $m_u$ : atomic mass constant
- F: Faraday constant
- R: molar gas constant
- k: Boltzmann constant
- $V_m$ : molar volume of ideal gas (273.15 K, 100 kPa)
- $\sigma$ : Stefan-Boltzmann constant

**Adopted Values**

- $K_{J-90}$ : conventional value of Josephson constant
- $R_{K-90}$ : conventional value of von Klitzing constant
- $g_n$ : standard acceleration of gravity

## 17-3 Precautions

- The atomic weights in this application are based on those recommended by 2017 IUPAC (International Union of Pure and Applied Chemistry).
- Electron configurations are based on information in the “CRC Handbook of Chemistry and Physics 91st Edition”.
- The physical constants in this application are based on those recommended by the 2014 CODATA.
- A scientific constant in this application may be slightly different depending on the year it is presented or books it is presented. Refer to appropriate information that fits your purpose before use.
- The classification of rare earth elements may be slightly different from those in typical textbooks or magazines in the USA.
- The classification of transition elements may be slightly different from those in typical textbooks or magazines in the USA.
- Copyrights of the element graphic images revert to the individuals shown in the table below.

Element Name	Copyright Holder
Hydrogen	© ordus - Fotolia.com
Helium	© Elenathewise - Fotolia.com
Lithium	© Coprid - Fotolia.com
Beryllium	© travis manley - Fotolia.com
Carbon	© Paylessimages - Fotolia.com
Nitrogen	© Stefan Korber - Fotolia.com
Oxygen	© Kor_Alex - Fotolia.com
Fluorine	© philippe Devanne - Fotolia.com
Neon	© Akasha+ - Fotolia.com
Sodium	© davide tesoriero - Fotolia.com
Magnesium	© Aviator70 - Fotolia.com
Aluminium	© StudioAraminta - Fotolia.com
Silicon	© wolandmaster - Fotolia.com
Phosphorus	© Swettlana Gordacheva - Fotolia.com
Sulfur	© Alexander Mandl - Fotolia.com
Chlorine	© L. Shat - Fotolia.com
Argon	© uhotti - Fotolia.com
Potassium	© Stefan Korber - Fotolia.com
Calcium	© Birute Vijeikiene - Fotolia.com
Scandium	© Melinda Nagy - Fotolia.com
Titanium	© christian42 - Fotolia.com
Vanadium	© Thomas Reimer - Fotolia.com
Chromium	© sav_a - Fotolia.com
Manganese	© cardiae - Fotolia.com
Iron	© Novydel - Fotolia.com
Cobalt	© SpbPhoto - Fotolia.com
Nickel	© John Sfondilias - Fotolia.com
Copper	© effe45 - Fotolia.com
Zinc	© ibphoto - Fotolia.com

Element Name	Copyright Holder
Gallium	© Ron-Heidelberg - Fotolia.com
Germanium	© Dario Sabljak - Fotolia.com
Selenium	© Konstantin Shevtsov - Fotolia.com
Bromine	© Rade Cojbasic - Fotolia.com
Krypton	© Morad HEGUI - Fotolia.com
Strontium	© jonnysek - Fotolia.com
Yttrium	© Jean-Philippe Capart - Fotolia.com
Zirconium	© Hiro - Fotolia.com
Niobium	© Alexandr Blinov - Fotolia.com
Molybdenum	© vnlit - Fotolia.com
Ruthenium	© DeVice - Fotolia.com
Rhodium	© Pix by Marti - Fotolia.com
Palladium	© Pix by Marti - Fotolia.com
Silver	© Zee - Fotolia.com
Cadmium	© Florian Ertl - Fotolia.com
Indium	© 263 - Fotolia.com
Tin	© dvs71 - Fotolia.com
Antimony	© Andrew Barker - Fotolia.com
Tellurium	© fotografiche.eu - Fotolia.com
Iodine	© Aleksandr Bedrin - Fotolia.com
Xenon	© Eimantas Buzas - Fotolia.com
Caesium	© John Tomaselli - Fotolia.com
Barium	© Jim Parkin - Fotolia.com
Lanthanum	© Tyler Olson - Fotolia.com
Cerium	© photoiron - Fotolia.com
Praseodymium	© Dario Bajurin - Fotolia.com
Neodymium	© Igor Tarasov - Fotolia.com
Samarium	© ケンジ - Fotolia.com

<b>Element Name</b>	<b>Copyright Holder</b>
Europium	© wrangler - Fotolia.com
Gadolinium	© khz - Fotolia.com
Terbium	© Dragan Radojkovic - Fotolia.com
Dysprosium	© jonnysek - Fotolia.com
Holmium	© beerkoff - Fotolia.com
Erbium	© Kitch Bain - Fotolia.com
Thulium	© Nomad_Soul - Fotolia.com
Ytterbium	© Dmitrijs Gerciks - Fotolia.com
Lutetium	© Viktor - Fotolia.com
Tantalum	© Elridge - Fotolia.com
Tungsten	© Sylvie Thenard - Fotolia.com
Rhenium	© zmkstudio - Fotolia.com
Osmium	© llandrea - Fotolia.com
Iridium	© MACLEG - Fotolia.com
Platinum	© Soul Concept - Fotolia.com
Gold	© Paylessimages - Fotolia.com
Mercury	© marcel - Fotolia.com
Lead	© dabjola - Fotolia.com
Bismuth	© Tommy - Fotolia.com
Radon	© TOMO - Fotolia.com
Uranium	© philipus - Fotolia.com

# Chapter 18: System Application

You can use the System application to manage ClassPad memory (main memory, the eActivity area, and the storage area), and to configure various system settings.

## 18-1 Managing Memory Usage

ClassPad has the following three independent memory areas for storing data: main memory area, eActivity area, and storage area.

**Main memory:** This area is for storage of application data and variables, except for eActivity.

**eActivity area:** This area is for storage of eActivity data.

**Storage area:** All ClassPad data can be exported as a single VCP file, and individual main memory and/or eActivity area data items can be exported as individual XCP files and stored in this area. When the ClassPad is connected to a computer via a USB connection, this area can be used to transfer data between the ClassPad and computer (page 288).

Starting up the System application displays a screen with three tabs, one for each of the memory areas described above. Tapping a tab will display a sheet for performing the operations below for the applicable memory area.

- Delete main memory and eActivity area data
- Search for and delete files and folders in the storage area, and create and rename folders
- Import and export data (variable and eActivity) between main memory and the eActivity area, and the storage area

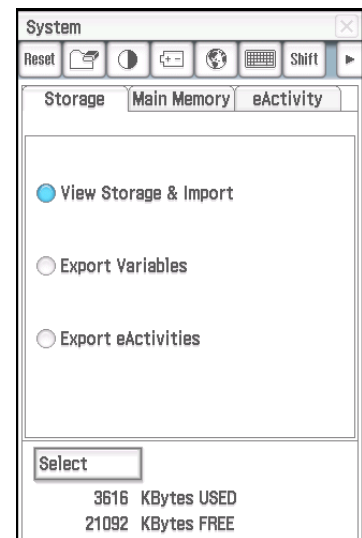

---



### Using the Storage Sheet

The [Storage] sheet appears first whenever the System application is started up. You can use this sheet to import and export files. For details, see “VCP and XCP File Operations” (page 289). Here, we will display the contents of the storage area, and show how to rename a file and delete a file.

#### • To view storage area contents

1. On the System application window, tap the [Storage] tab.
2. Select “View Storage & Import” and then tap [Select].
  - This displays the Storage dialog box. It shows the folders and files in the storage area.
3. On the Storage dialog box, perform the folder and file operations described below.

To do this:	Do this:
Delete a folder or file	Select the check box of the folder or file you want to delete and then tap [File] - [Delete].
Create a folder	Tap [File] - [Create Folder] or  . On the dialog box that appears, enter the name you want to assign to the folder and then tap [OK].
Rename a folder	Highlight the folder you want to rename and then tap [File] - [Rename]. On the dialog box that appears, enter the name you want to assign to the folder and then tap [OK].

To do this:	Do this:
Search for a file or folder	Tap [Search] or  . On the dialog box that appears, enter the character string you want to search for and then tap [Search]. To search again using the same character string, tap  .
Change the file list view	To display both the file name and file size, tap [View] - [Detail View] (long file names may be cut off). To display the file name only, tap [View] - [List View].

4. Tap [Cancel] to close the Storage dialog box.

## Using the Main Memory Sheet and eActivity Sheet

### Main Memory Sheet

Tapping the [Main Memory] tab displays the Main Memory sheet.

This item:	Shows how much memory is used by this type of data:
Setup	Setup data
Graph Sheet	Graph & Table application function data (including sheet name data and function selection data)
3D Graph Sheet	3D Graph application function data (including sheet name data and function selection data)
Graph Summary	Summary table data
View Window	View Window parameter values
3D View Window	3D View Window parameter values
Factor	Zoom factor values
Table	Range values and table result values
Conics Eqn	Conics expressions
Sequence	Sequence application data
DiffEqGraph	Differential Equation Graph application function data
Stat List	list1 through list6
Stat Result	Statistical calculation results
Numeric Solve	Solve expression and solve range
Ans Memory	Main application Ans data
Random Value	Random command setting data
Main History	Main application history data
User Defined	User-defined variables and user-created folders
Library	“library” folder data
eActivity	eActivity application temporary data*
Geometry	Geometry application temporary data*
Spreadsheet	Spreadsheet application temporary data*
Financial	Financial application data
Picture Plot	Picture Plot application temporary data*
DiffCalc	Interactive Differential Calculus application data
System	Other system data
Clipboard	Clipboard data

\* “temporary data” is data that is created by an application but not saved as a file.



## eActivity Sheet

Tapping the [eActivity] tab displays the eActivity sheet. This sheet lists the names of all the files that have been created with the eActivity application, and shows the size of each file.

### • To delete Main Memory data or eActivity files

1. Tap the tab (Main Memory or eActivity) that contains the data you want to delete.
2. Select the check box next to the item whose data you want to delete.
3. Tap the [Delete] button.
4. On the confirmation dialog box that appears, tap [OK] to delete the selected data.
  - Tapping [OK] displays the message “Now deleting...” while the data is being deleted.

### Tip













- You cannot delete any data that has a dimmed check box.
- For information about deleting all variable data and program data, and deleting all eActivity data, see “To batch delete specific data (Reset)”.

## 18-2 Configuring System Settings

Use the System application menu or toolbar buttons to configure system settings.

---

### System Application Menus and Buttons

- Batch delete specific memory area data ..... System - Reset or 
- Initialize the ClassPad ..... System - Initialize or 
- Adjust display brightness ..... System - Display Settings or 
- Configure power properties ..... System - Power Properties - Power or 
- Specify the battery type being used ..... System - Power Properties - Battery or 
- Change the display text language ..... System - Language or 
- Specify the complex number imaginary unit ..... System - Imaginary Unit
- Change the arrangement of the alphabet soft keyboard ..... System - Keyboard or 
- Assign shift mode key operations to hard keys ..... System - Shift Keys or 
- Optimize eActivity area and storage area ..... System - Memory Management or 
- Select the image data for the ending screen that appears when the ClassPad is turned off ..... System - Ending Screen or 
- Adjust the alignment of the touch panel ..... System - Touch Panel Alignment or 
- Display software version information ..... System - About - Version or 
- Register a user name on a ClassPad ..... System - About - User Name

---

### Configuring System Settings

#### • To batch delete specific data (Reset)

1. On the System application window, tap [System] - [Reset], or tap .
  - This displays the Reset dialog box.

2. On the Reset dialog box, select the type of reset operation you want to perform.

To delete this type of data:	Select this option:
All variable and program data in main memory	Variable/Program
All eActivity data in eActivity area	eActivity Data
Data in storage area	Storage Memory
All of the above three types	All of the above

3. After selecting the type of reset operation you want to perform, tap [Reset].

4. In response to the confirmation message that appears, tap [OK] to perform the reset operation and return to the application menu.

### • To initialize your ClassPad

#### **Warning!**

Initializing the ClassPad deletes anything you have input and stored in memory (including eActivity data) since you purchased the ClassPad or last initialized it. Before initializing the ClassPad, double-check to make sure you do not need any of the data that will be deleted.

1. On the System application window, tap [System] - [Initialize], or .

- This displays a confirmation asking if you really want to initialize your ClassPad.

2. Tap [OK] to perform the initialize operation.

- The initialize operation may take several minutes to complete (depending on the amount of data stored in memory).
- After the initialize operation is complete, the Language screen will appear. Follow the instructions on the screen to configure initial settings. For more information about the setup operation, see “Loading Batteries and Setting Up the ClassPad” in the separate Quick Start Guide.

### • To adjust display brightness

1. On the System application window, tap [System] - [Display Settings], or .

2. Tap  or  to change display brightness, and then tap [Set].

- Tapping [Initial] returns display brightness to its initial default.

### • To configure power properties

1. On the System application window, tap [System] - [Power Properties] - [Power], or .

2. On the dialog box that appears, perform the operations described below.

To do this:	Do this:
Specify the Auto Power Off trigger time	Tap the “Auto Power Off” down arrow button and then select 10 min or 60 min.
Specify the backlight duration	Tap the “Backlight Duration” down arrow button and then select 30 sec, 1 min, 3 min, or 10 min.

3. After all the settings are the way you want, tap [Set].

### • To specify the battery type

1. On the System application window, tap [System] - [Power Properties] - [Battery], or .

2. Tap the type of battery you loaded and then tap [Set].

3. On the confirmation dialog box that appears, tap [OK].

- This registers the selected battery type and closes the confirmation dialog box.

- If you tap [Cancel] instead of [OK], the confirmation dialog box will close without registering the selected battery type.

### • To specify the display language

1. On the System application window, tap [System] - [Language], or .
2. On the dialog box that appears, select the language you want to use, and then tap [Set].
  - This returns to the application menu.

### • To specify the complex number imaginary unit (*i* or *j*)

1. On the System application window, tap [System] - [Imaginary Unit].
2. On the dialog box that appears, select the type of imaginary unit you want to use, and then tap [Set].

### • To specify the alphabetic keyboard arrangement

1. On the System application window, tap [System] - [Keyboard], or .
2. On the dialog box that appears, select the keyboard arrangement you want to use, and then tap [Set].
  - This returns to the application menu.

### • To assign shift mode key operations to hard keys



























1. On the System application window, tap [System] - [Shift Keys], or .
  - This displays the Shift Key Assign dialog box.
2. Tap the down arrow button then select the hard key to which you want to assign a shift mode operation.
3. Specify the operation you want to assign to the hard key.

To do this:	Do this:
Assign an auto text (string, function name, etc.) input operation to the hard key	Enter the text you want to auto input to the right of the [Set] button and then tap [Set].
Assign the Cut, Copy, Paste, or Undo/Redo operation to the hard key	Tap the applicable button on the dialog box.
Clear the current assignment from the hard key	Tap [Clear].
Return all key assignments to their initial defaults	Tap [Default].

- The operation assigned to the hard key is displayed in the status bar.
4. After all the settings are the way you want, tap [OK] to apply them and close the Shift Key Assign dialog box.

### Tip

- Performing any one of the following operations will cause all key assignments to be returned to their initial default settings: "To batch delete specific data (Reset)" (page 281), "To initialize your ClassPad" (page 282), or "To perform the RAM reset operation" (page 308).
- The initial default key assignments are shown below.

 : Copy	 : Cut	 : Paste	 : Undo
 : <i>t</i>	 : $\theta$	 : <i>l</i>	 : $\Rightarrow$
 : sin(	 : cos(	 : tan(	 : ln(
 : $\pi$	 : <i>i</i>	 : $\infty$	 : Ans
 : $\sqrt{\square}$ (Template Input Mode) or $\sqrt{\quad}$ (Line Input Mode)* <sup>1</sup>			
 : $\frac{\square}{\square}$ (Template Input Mode) or $\div$ (Line Input Mode)* <sup>1</sup>			
 : $e^{\square}$ (Template Input Mode) or $e^{\quad}$ (Line Input Mode)* <sup>1</sup>			
 : $\log_{\square}(\square)$ (Template Input Mode) or $\log(\quad)$ (Line Input Mode)* <sup>1</sup>			
 ,  ,  ,  ,  ,  : Undefined			

\*<sup>1</sup> See "Template Input and Line Input" (page 24).

### • To optimize Flash ROM (eActivity area and storage area)

**Tip:** Optimizing Flash ROM increases the amount of memory available for storage.

1. On the System application window, tap [System] - [Memory Management], or .
2. On the confirmation dialog box that appears, tap [Yes].
  - After you tap [Yes], the message “Now Optimizing...” remains displayed while optimization is in progress. The message “Complete!” appears when optimization is complete.

#### **Important!**

Never press the RESTART button on the back of the ClassPad while a Flash ROM optimization operation is in progress. Doing so can damage memory, resulting in loss of all memory contents and malfunction of your ClassPad. If this happens, you will need to request repair from your CASIO Maintenance Service Provider. Note that repair of your ClassPad will not recover any lost memory contents.



3. Tap [OK] to close the “Complete!” message dialog box.

### • To select the image data for the ending screen that appears when the ClassPad is turned off

1. On the System application window, tap [System] - [Ending Screen], or .
2. On the dialog box that appears, tap the down arrow button. On the list that appears, tap [Select Picture File] and then tap the ending screen image you want to use.
  - Tapping the [View] button displays a preview of the currently selected screen image. Tap [OK] to close the preview image.
3. After the image you want is selected, tap [Set].

### • To adjust touch panel alignment

1. On the System application window, tap [System] - [Touch Panel Alignment], or .
2. Use the stylus to tap the center of each of the four crosses as they appear on the screen.
  - When aligning your ClassPad try to tap the exact center of each cross.

**Tip:** The Touch Panel Alignment screen in step 2 above will also appear if you press the following keys at the same time while the ClassPad is turned off:   .

### • To view version information

On the System application window, tap [System] - [About] - [Version], or . Tap [OK] to close the Version dialog box.

### • To register a user name on a ClassPad

1. On the System application window, tap [System] - [About] - [User Name].
2. On the dialog box that appears, enter your name, and then tap [Set].
  - The user name you registered appears at the bottom of the ending screen that appears when the ClassPad is turned off.

# Chapter 19: Performing Data Communication

You can connect your ClassPad to a computer or to another ClassPad and exchange data with the connected device. You can also connect to a Data Logger or a CASIO projector. This chapter explains how to connect a ClassPad to an external device and how to transfer data between them.

## **Important!**

Do not press the RESTART button on the back of the ClassPad while a data communication operation is in progress. Doing so can damage memory, resulting in loss of all memory contents and malfunction of your ClassPad. If this happens, you will need to request repair from your CASIO Maintenance Service Provider. Note that repair of your ClassPad will not recover any lost memory contents.

## 19-1 Data Communication Overview

This section explains how to configure communication parameters using the Communication application, and how to use the Select Connection Mode dialog box that appears when you establish a USB connection between your ClassPad and an external device.

---

### Using the ClassPad Communication Application

Before trying to transfer data with the ClassPad, you should perform the procedures described in this section to configure its data communication parameters.

#### • To configure communication parameters

1. On the application menu, tap  .
  - This starts the Communication application and displays a window that shows its current communication parameter settings.

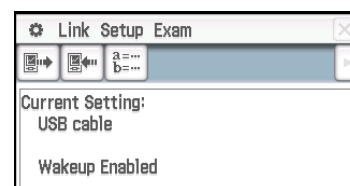

2. Tap [Setup] and then [Open Setup Menu].
  - This displays a dialog box for changing communication parameters, like the one shown nearby.
3. Configure the communication parameter settings as described below.
  - Items marked with an asterisk (\*) are initial defaults.

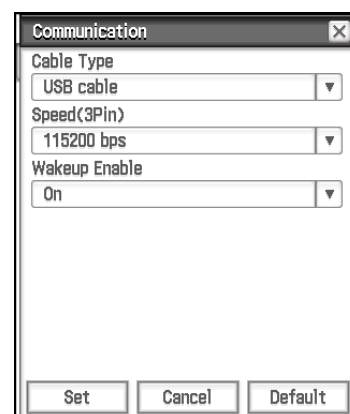

**Cable Type:** To connect to another ClassPad unit or a Data Logger, select “3pin cable”. To connect to a computer or a projector, select “USB cable\*”.

**Speed(3Pin):** Select “9600 bps”, “38400 bps” or “115200 bps\*” to specify data rate for 3-pin communication. This setting specifies the data rate when connected to another ClassPad, or a Data Logger. If the speed settings of the ClassPad and the connected device are different from each other, the slower setting is used.



**Wakeup Enable:** To turn on the wakeup function (see below), select “On\*”. To turn off the wakeup function, select “Off”. This setting is valid only the “3pin cable” is selected as the cable type.

4. When all the settings are the way you want, tap [Set] to save them.
  - The Communication application window appears at this time, with the new parameters you just configured. Check to make sure the settings are the way you want.

## Wakeup

Wakeup is a function that automatically puts the ClassPad into data communication standby whenever the ClassPad detects data coming in from an external device connected to the 3-pin port of the ClassPad. When the sending device performs a data send operation, the receiver device's wakeup function activates and data receive is performed automatically. The receiver device operates normally as long as no data is being received. Note that wakeup does not operate on the receiver device when any ongoing calculation or graphing operation is being performed. Wakeup activates when the ongoing operation is complete.

## Communication Application Menus and Buttons

- Select data to send ..... Link - Transmit or 
- Enter receive standby ..... Link - Receive or 
- Enter standby for operating system upgrading ..... Link - OS Update
- Configure communication parameters ..... Setup - Open Setup Menu
- Display the Exam Mode menu (page 311)..... Exam
- Start up Variable Manager ..... 

## Select Connection Mode Dialog Box

Connecting ClassPad to a computer or projector with the USB cable will cause the Select Connection Mode dialog box shown nearby to appear. Tap the button that corresponds to device that ClassPad is connected to.

**USB Flash:** Mode for connecting ClassPad to a computer for data transfer. See “Connecting and Disconnecting with a Computer in the USB Flash Mode” (page 287) for details.

**Screen Receiver:** Mode for using the Screen Receiver software\*1 on a computer running Windows 7, Windows 8.1, Windows 10 or Mac OS, which displays ClassPad screen contents on the computer screen.

**Screen Receiver(XP):** Mode for using the Screen Receiver software\*1 on a computer running WindowsXP, which displays ClassPad screen contents on the computer screen.

**Projector:** Mode for connecting ClassPad to a projector and projecting ClassPad screen contents. See “Projecting ClassPad Screen Contents from a Projector” (page 294) for details.

**Cancel:** Closes the Select Connection Mode dialog box without changing the setting.

\*1 See the Screen Receiver User's Guide for details. Do not perform any operation on ClassPad until the ClassPad screen contents are displayed by Screen Receiver.

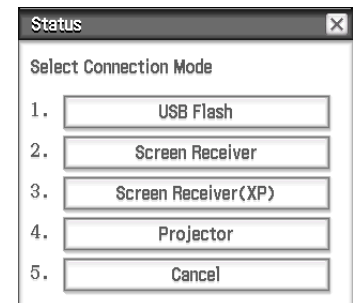

### Tip

- Instead of tapping on-screen buttons, you can also use the keypad keys **[1]** through **[5]** to select a connection mode.
- The Select Connection Mode dialog box will not appear right away if you connect the USB cable while a progress bar is displayed or while a calculation is in progress. Disconnect the USB cable and wait until the progress bar disappears or the calculation is complete, and then reconnect.

## 19-2 Performing Data Communication between the ClassPad and a Personal Computer

You can perform the following operations when connected to a computer.

### Transfer data between the ClassPad and a computer

Variable data and eActivity data, as well as VCP and XCP files (page 289) can be transferred between the ClassPad and a computer.

## Transfer ClassPad display image data to the computer

For information about connecting ClassPad and Screen Receiver, see the Screen Receiver User's Guide.

### Computer System Requirements

- Windows 7 (32-bit, 64-bit)
- Windows 10 (32-bit, 64-bit)
- Mac OS X 10.7, OS X 10.8, OS X 10.9, OS X 10.10, OS X 10.11, macOS 10.12
- Windows 8.1 (32-bit, 64-bit)

---

## Connecting and Disconnecting with a Computer in the USB Flash Mode

Establishing a USB connection between ClassPad and a computer will cause the computer to recognize the ClassPad's storage area as a USB Flash Drive.

### Important!

Do not touch the USB cable plugs and screen while a data communication operation is in progress. Static electricity from your fingers can cause data communication to be terminated.

### • To establish a connection between ClassPad and a computer

1. Connect one end of the USB cable that comes with the ClassPad to the USB port of your computer.
2. Connect the other end of the USB cable to the ClassPad as shown nearby.
  - The ClassPad will turn on automatically and the "Select Connection Mode" screen will appear.

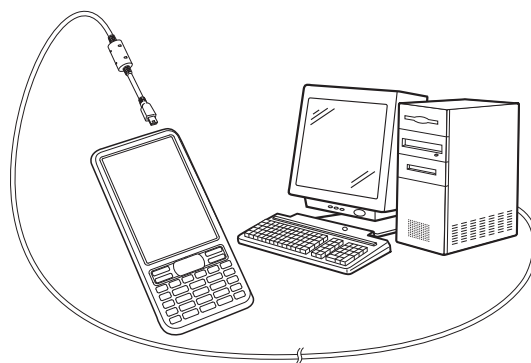

3. Tap [USB Flash].
  - Establishing a connection between the ClassPad and a computer will cause the screen shown nearby to appear.
4. On your computer, open the ClassPad drive.
  - The ClassPad drive represents the ClassPad's storage area.
5. Perform the required operation on your computer to transfer the data.

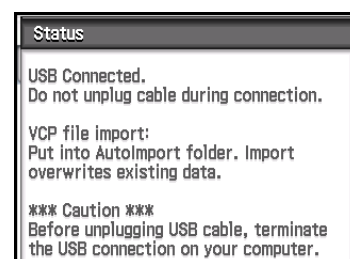

### • To terminate the connection between the ClassPad and a computer

1. Depending on the type of operating system your computer is running, perform one of the following operations.
    - Windows:** First, check the drive letter (E, F, G, etc.) assigned to the ClassPad drive. Click the "Safely Remove Hardware" icon in the toolbar in the lower right corner of the display. On the menu that appears, select the "USB mass storage device" whose letter matches the ClassPad drive letter. Check to make sure the "Safe To Remove Hardware" message is displayed.
    - Mac OS:** Drag the ClassPad drive icon to the Eject icon (Trash icon). Check to make sure that the ClassPad drive icon is no longer on your desktop.
  2. The message "Complete!" will appear on the ClassPad screen.\* To close the message dialog box, tap [OK].
  3. Disconnect the USB cable from the ClassPad.
- \* With some computer operating systems, the "Complete!" message will not appear on the ClassPad screen. If this happens, disconnect the USB cable from the ClassPad. When a confirmation message appears on the ClassPad screen, tap [OK].

---

## Transferring Data between the ClassPad and a Personal Computer

Establishing a connection between ClassPad and a computer in USB Flash mode displays folder and files stored in the ClassPad storage area as folders and files in the computer's ClassPad drive.

ClassPad has the following three independent memory areas for storing data: main memory area, eActivity area, and storage area. For details about these areas, see Chapter 18.

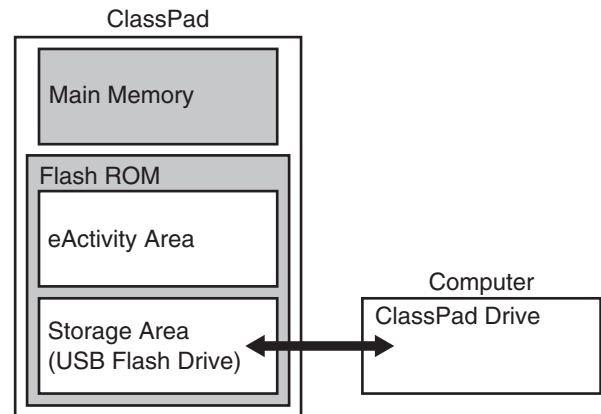

### **Important!**

Do not use a computer operation to format the ClassPad drive. Doing so will cause a “File System ERROR” message to appear on the ClassPad screen after you terminate the USB connection between the ClassPad and computer. When this happens, you will not be able to start up the ClassPad unless you perform an initialize operation, which deletes all data currently in ClassPad memory.

### **Note**

- When copying files to the ClassPad drive, it may take several minutes before copying starts. This is because copying automatically performs optimization of the ClassPad's Flash ROM. It does not indicate malfunction.
- Copying files to the ClassPad drive can cause the connection between the ClassPad and computer to be dropped. If this happens, enter the System application and execute a Flash ROM optimize operation (page 284), and then re-establish a connection between the ClassPad and computer.
- A USB connection between the ClassPad and a computer may be terminated automatically if the computer enters a power save mode, sleep mode, or any other standby state.

### **• To transfer data between ClassPad and a computer**

1. When transferring data from your ClassPad to a computer, first perform the operations below.
  - Export the data from the main memory or eActivity area to the storage area. Exported data is stored as an XCP file, which is a ClassPad proprietary file format. See “To export variable data to XCP files” (page 290) and “To export eActivity data to XCP files” (page 291).
  - If you want to copy all ClassPad data to a computer, save all of the file data as a VCP file, which is also a ClassPad Proprietary file format. See “To save a VCP file” (page 290).
2. Establish a connection between the ClassPad and computer, and then open the ClassPad drive on the computer.
  - See “To establish a connection between ClassPad and a computer” (page 287).
3. Perform copy, delete, and other file operations as required.
  - If you have a VCP file or XCP file you want to transfer to ClassPad, copy it to the ClassPad drive.
4. After you finish all the operations you want to perform, terminate the USB connection between ClassPad and the computer.
  - When you terminate a USB connection, ClassPad automatically imports a VCP file currently in the AutoImport folder. For details, see “Auto Import of VCP Files” below.
  - For information about how to import a VCP file manually, see “To open a VCP file” (page 290).
  - For information about how to import an XCP file manually, see “To import an XCP file” (page 291).

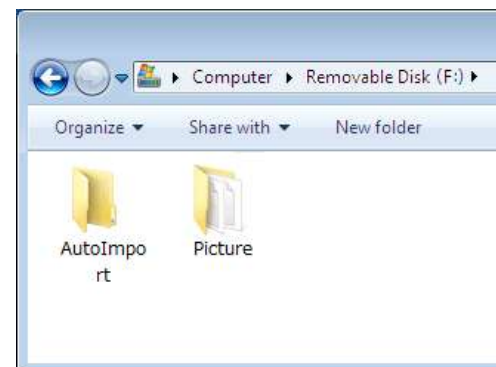



---

## Installing an Add-in Application

Use the procedure below to install an add-in application (c2a file).

1. Perform steps 1 through 4 under “To establish a connection between ClassPad and a computer” (page 287).
2. Copy the add-in application’s dc2a file to the ClassPad root directory.
3. Terminate the USB connection between ClassPad and the computer.  
See “To terminate the connection between the ClassPad and a computer” (page 287).
  - The icon of the application you just installed should now be visible on the application menu.

---

## Auto Import of VCP Files

When you terminate a USB connection, ClassPad automatically imports a VCP file currently in the AutoImport folder on the storage area.

- Only one VCP file inside the top level of the AutoImport folder is imported to main memory and the eActivity area. Existing data is overwritten and new data is added. If there are multiple VCP files in the AutoImport folder, you need to select the one to be imported manually.
- After auto import is complete, all folders and files in the AutoImport folder are moved to the SAVE-F folder.

**Tip:** The error message “Insufficient Memory” will appear if main memory or eActivity area memory runs low during the import operation. If this happens, delete data you no longer need from the main memory or eActivity area and try importing again.

---

## Rules for ClassPad Files and Folders

- Up to 200 files per folder can be displayed on the storage memory information screen. If a folder has more than 200 files and you need to display them all, divide them among multiple folders so the total number of files in a single folder is not greater than 200.
- Though you can create folders on your computer nested to more than three levels in storage memory, the ClassPad will display only up to the third level.
- The following are characters that can be used in file names and folder names.  
A–Z, a–z, 0–9, !, #, \$, %, ', ,(comma), (, ), +, −, ., ;, =, @, [, ], ^, \_, ` , ~, space

---

## VCP and XCP File Operations

When saving ClassPad eActivity data or variable data for storage on a computer or in the ClassPad storage area, you need to convert it to a VCP file or XCP file. VCP files and XCP files can be imported later to ClassPad from a computer or the ClassPad storage area when required.

A save operation saves the following variables and eActivity files.

(1) System variables: Ans,  $a_0$ , list1,  $x_{min}$ , and other data

(2) User variables: Files saved with Geometry, Spreadsheet, Program, etc.  
List files, Mat files, etc.  
Image files saved as hard copies

(3) eActivity files

- Saving to a VCP file (\*\*\*.vcp) saves all of the above files and data currently in ClassPad main memory and eActivity area.
- Saving (exporting) to an XCP file (\*\*\*.xcp) saves only the variables or eActivity files for a specific data type (eActivity, Geometry, Spreadsheet, etc.).

VCP and XCP files can be transferred between ClassPad and a computer when there is a USB Flash mode connection between them. For details, see “Transferring Data between the ClassPad and a Personal Computer” (page 288).

### • To save a VCP file

1. On the icon panel, tap  to display the application menu.
2. Tap [MENU] at the top left of the application menu, and then tap [Save As].
3. On the file specification dialog box that appears, enter the file name and then tap [Save].
  - On the “Complete!” dialog box that appears, tap [OK].

### • To open a VCP file

1. On the icon panel, tap  to display the application menu.
2. Tap [MENU] at the top left of the application menu, and then tap [Open].
  - This causes a file specification dialog box to appear. It shows the VCP files in the storage area.
3. Select the VCP file you want to open and then tap [Open].
  - This displays the dialog box shown nearby.
4. Select the file import option you want and then tap [OK].
  - ① Deletes all data in the main memory and eActivity area and import the file.
  - ② Overwrites existing data as necessary and imports non-existent data as new data.
5. Tap [OK].

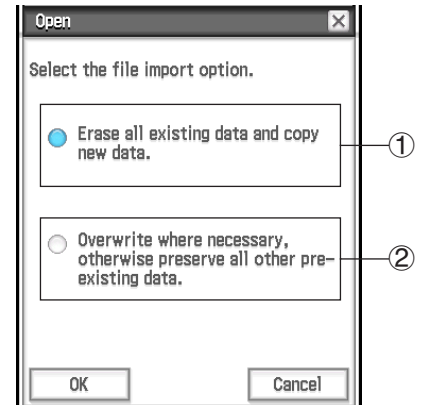

### • To create a new VCP file

1. On the icon panel, tap  to display the application menu.
2. Tap [MENU] at the top left of the application menu, and then tap [New].
  - This displays the dialog box shown nearby.
3. To reset the ClassPad main memory and eActivity area, tap [OK].

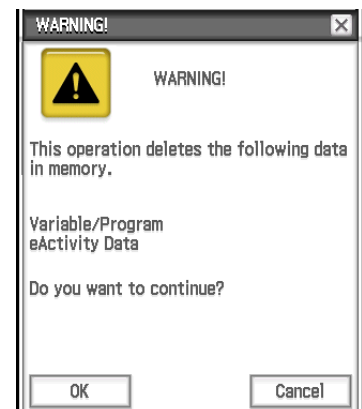

### • To export variable data to XCP files

1. On the application menu, tap  to start up the System application.
2. On the [Storage] sheet that appears, select “Export Variables” and then tap [Select].
  - This displays a dialog box for selecting a folder.
3. Select the folder or variables you want to export.
  - The selection operation is the same as that for Variable Manager. For details, see “Using Variable Manager” (page 29).
  - When multiple variables are selected, each variable is exported to a different XCP file.
4. Tap [Export].
  - This displays a dialog box for selecting the export destination folder.
5. Select the export destination folder you want and then tap [OK].

- **To export eActivity data to XCP files**

1. On the application menu, tap  to start up the System application.
2. On the [Storage] sheet that appears, select “Export eActivities” and then tap [Select].
  - This displays the eActivity data selection dialog box.
3. Select the eActivity you want to export.
4. Tap [Export].
  - This displays a dialog box for selecting the export destination folder.
5. Select the export destination folder you want and then tap [OK].

- **To import an XCP file**

1. On the application menu, tap  to start up the System application.
2. On the [Storage] sheet that appears, select “View Storage & Import” and then tap [Select].
  - This displays the Storage dialog box. It shows the folders and files in the storage area.
3. Select the XCP files you want to import and then tap [Import].
4. On the dialog box that appears, select the import destination folder you want, and then tap [OK].

## 19-3 Performing Data Communication between Two ClassPads

This section explains the operations required for transferring data from one ClassPad to another.

---

### Connecting to Another ClassPad Unit

1. Turn both units off.
2. Connect the data communication cable as shown in the nearby illustration. Insert both of the plugs securely, as far as they will go.

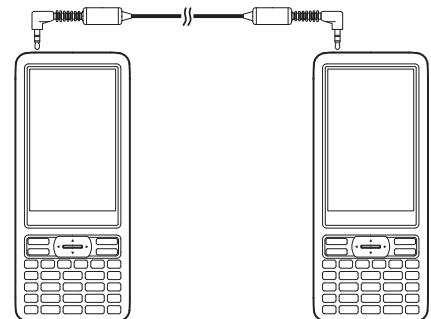

---

### Transferring Data between Two ClassPads

You can transfer variable data and eActivity data between two ClassPad units. You can use either of the two following methods to transfer data between two ClassPad units.

- Use the Communication application. The procedure below shows how to use this method.
- Use the “SendVar38k” and “GetVar38k” program commands. See “12-4 Program Command Reference”.

• **ClassPad Operation**

1. Use the procedure under “Connecting to Another ClassPad Unit” above to connect the two units.
2. Use the procedure under “To configure communication parameters” (page 285) to configure the parameters of the two units as shown below.
  - Cable Type: 3pin cable
  - Speed (3Pin): 115200 bps
  - Wakeup Enable: On

**On the sending ClassPad:**

3. On the Communication application window, tap [Link] - [Transmit], or tap .
  - This displays the Select Data dialog box. A list that shows user folders and the “main” folder appears first.

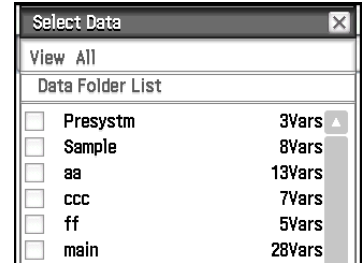

4. Select the data you want to send.
  - (1) Tap the [View] menu and then select the data type from the list that appears.

To list this on the Select Data dialog box:	Select this [View] menu command:
User folders and the “main” folder	Data Folder List
Library variables	Library
System variable groups	Application Status
eActivity folders	eActivity Folder List

- (2) Select the data you want to send.
  - On the Select Data dialog box, select the check box next to the data you want to send. You can also tap the [All] menu and select one of the following commands to select or deselect data.

To do this:	Select this [All] menu command:
Select all currently displayed items	Select List
Deselect all currently displayed items	Deselect List
Select all items in all lists	Select All Lists
Deselect all items in all lists	Deselect All Lists

- Opening a folder in [Data Folder List] or [eActivity Folder List] displays the variables and data contained inside it, which can be individually selected for transfer. To select a variable or data contained in a particular folder, tap its folder name to open it. To return to the folder list from a list of folder contents, tap  in the lower left corner of the window.
- You can transfer all of the variables or data in a folder by selecting the check box next to the folder name on the data folder list or eActivity folder list.

5. Tap [OK].
6. In response to the confirmation message that appears, tap [OK] to send the data.
  - This sends the data you selected in step 4, and the receiving ClassPad automatically starts receiving the data.
  - The message “Complete!” appears to let you know when the send operation is finished.
7. Tap [OK] to return to the Select Data dialog box.
8. On the Select Data dialog box, tap [Cancel].
  - This returns to the Communication application window.

**On the receiving ClassPad:**

9. The message “Complete!” appears to let you know when the receive operation is finished. Tap [OK].

### Tip

- When wakeup is turned off on the receiving device, you need to perform the following operation on the receiving device before performing step 3:  
Start up the Communication application, tap [Link] and then [Receive], or tap .  
This puts the receiving unit into receive standby, which is indicated by the Standby dialog box on the display.
- When you send a variable or data item, it is normally stored in the current folder of the receiving device. A variable or data item sent from the “library” folder of the sending device, however, is stored in the “library” folder of the receiving device.

---

## Communication Standby

The ClassPad enters “communication standby” when you perform a send or receive operation. While in communication standby, the ClassPad waits for the other unit to send data, or for it to get ready to receive data.

The following describes how communication standby affects certain ClassPad operations.

- Auto Power Off (page 282) becomes disabled.
- ClassPad power cannot be turned off.
- If data communication does not start within three minutes after the ClassPad enters data communication standby, the message “Timeout” appears. When this happens, tap [Retry] to try again or [Cancel] to cancel the data communication operation.

---

## Interrupting an Ongoing Data Communication Operation

Pressing the  key on either the sending device or receiving device during a data communication operation terminates it.

# 19-4 Connecting the ClassPad to a Data Logger

You can connect the Data Logger to your ClassPad and control Data Logger operation from your ClassPad.

---

## Connecting a ClassPad to a Data Logger

1. Turn off the ClassPad and Data Logger.
2. Connect one end of the data communication cable (supplied SB-62 cable) to the port of the Data Logger.
3. Connect the other end of the data communication cable to the 3-pin communication port of the ClassPad.

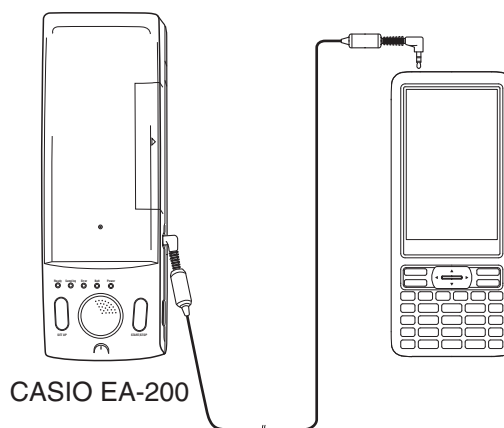

### Tip

- For information about what you should do to transfer data, see the user documentation that comes with the EA-200.
- You can transfer setup information from the ClassPad to the Data Logger, trigger sampling from the ClassPad, and graph sample results on your ClassPad. You can perform this procedure using the E-CON3 application, which is built into the ClassPad. For details about the E-CON3 function and its operation, see the E-CON3 Application User's Guide.

## 19-5 Connecting the ClassPad to a Projector

You can connect the ClassPad to a CASIO projector and project ClassPad screen contents onto a screen. For information about connectable projectors, visit the site below.  
<https://edu.casio.com/support/projector/>

### **Important!**

Some projector models may require a firmware update in order to project ClassPad screen contents. Before doing anything, go to the website above and check if your projector model requires updating.

---

### Projecting ClassPad Screen Contents from a Projector

1. Turn off the ClassPad.
2. Connect one end of the special cable that comes with the ClassPad to the USB port of your projector.
3. Connect the other end of the special cable as shown nearby.
  - ClassPad will turn on automatically and the Select Connection Mode screen will appear.
4. Tap [Projector].
5. On the dialog box that appears, tap [OK].

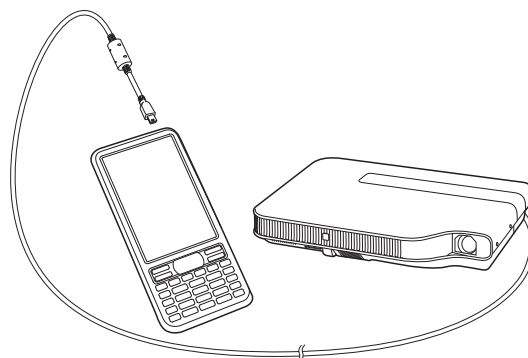

---

### Precautions when Connecting

- An hourglass figure may remain projected on the screen after you connect the ClassPad to a projector. Also, changing to another screen while a graph is being drawn or while a program is running could possibly result in the projected screen being different from the ClassPad screen. If this happens, performing some operation on the ClassPad will restore normal display.
- If the ClassPad stops operating normally, disconnect the USB cable and then reconnect it. If this does not correct the problem, disconnect the USB cable, turn the projector off and then back on, and then reconnect the USB cable.

# Appendix

## Character Code Table

Characters from character code 257 onwards are 2-byte characters.

32		48	0	64	@	80	P	96	`	112	p
33	!	49	1	65	A	81	Q	97	a	113	q
34	"	50	2	66	B	82	R	98	b	114	r
35	#	51	3	67	C	83	S	99	c	115	s
36	\$	52	4	68	D	84	T	100	d	116	t
37	%	53	5	69	E	85	U	101	e	117	u
38	&	54	6	70	F	86	V	102	f	118	v
39	'	55	7	71	G	87	W	103	g	119	w
40	(	56	8	72	H	88	X	104	h	120	x
41	)	57	9	73	I	89	Y	105	i	121	y
42	*	58	:	74	J	90	Z	106	j	122	z
43	+	59	;	75	K	91	[	107	k	123	{
44	,	60	<	76	L	92	\	108	l	124	
45	-	61	=	77	M	93	]	109	m	125	}
46	.	62	>	78	N	94	^	110	n	126	~
47	/	63	?	79	O	95	_	111	o		

257	À	270	Í	283	Û	296	Ď	309	Ī	322	Ń
258	Á	271	Î	284	Ü	297	Đ	310	Ī	323	Ņ
259	Â	272	Ï	285	Ý	298	Ě	311	Ī	324	Ň
260	Ã	273	Ď	286	Ɔ	299	Ě	312	Ī	325	Ŋ
261	Ä	274	Ñ	287	Ɔ	300	È	313	İ	326	Ō
262	Å	275	Ò	288	Ÿ	301	Ę	314	Ĳ	327	Ö
263	Æ	276	Ó	289	Ā	302	Ě	315	Ĳ	328	Ő
264	Ç	277	Ô	290	Ǻ	303	Ĝ	316	Ĳ	329	Œ
265	È	278	Õ	291	Ą	304	Ĝ	317	Ĳ	330	Ŕ
266	É	279	Ö	292	Ć	305	Ĝ	318	Ĳ	331	Ŗ
267	Ê	280	Ø	293	Ĉ	306	Ĝ	319	Ĳ	332	Ř
268	Ë	281	Ù	294	Č	307	Ĥ	320	Ĳ	333	Ś
269	Ì	282	Ú	295	Č	308	Ĥ	321	Ĳ	334	Ŝ

335	Ş	358	Ū	381	Ψ	404	Φ	427	<b>K</b>	487	7
336	Š	359	À	382	Ω	405	Χ	428	<b>L</b>	488	8
337	Ț	360	В	383	Α	406	Ц	429	<b>M</b>	489	9
338	Ț	361	Г	384	Б	407	Ч	430	<b>N</b>	490	+
339	Ʀ	362	Δ	385	В	408	Ш	431	<b>O</b>	491	-
340	Ū	363	Ε	386	Г	409	Щ	432	<b>P</b>	496	0
341	Ū	364	Z	387	Д	410	Ъ	433	<b>Q</b>	497	1
342	Ū	365	Н	388	Ε	411	Ы	434	<b>R</b>	498	2
343	Ū	366	Θ	389	Ё	412	Ь	435	<b>S</b>	499	3
344	Ū	367	Ι	390	Ж	413	Э	436	<b>T</b>	500	4
345	Ū	368	Κ	391	З	414	Ю	437	<b>U</b>	501	5
346	Ū	369	Λ	392	И	415	Я	438	<b>V</b>	502	6
347	Ū	370	Μ	393	Й	416	Є	439	<b>W</b>	503	7
348	Ž	371	Ν	394	К	417	<b>A</b>	440	<b>X</b>	504	8
349	Ž	372	Ε	395	Л	418	<b>B</b>	441	<b>Y</b>	505	9
350	Ž	373	Ο	396	М	419	<b>C</b>	442	<b>Z</b>	506	+
351	Ō	374	Π	397	Н	420	<b>D</b>	480	o	507	-
352	Ū	375	Ρ	398	Ο	421	<b>E</b>	481	1	508	-1
353	Ă	376	Σ	399	Π	422	<b>F</b>	482	2	509	m
354	Ī	377	Τ	400	Ρ	423	<b>G</b>	483	3	510	n
355	Ö	378	Υ	401	С	424	<b>H</b>	484	4		
356	Ū	379	Φ	402	Т	425	<b>I</b>	485	5		
357	Ū	380	Χ	403	У	426	<b>J</b>	486	6		

513	à	524	ë	535	ö	546	ǎ	557	ę	568	ı
514	á	525	ì	536	ø	547	ą	558	ě	569	ı
515	â	526	í	537	ù	548	ć	559	ğ	570	ij
516	ã	527	î	538	ú	549	ĉ	560	ğ	571	j
517	ä	528	ï	539	û	550	ċ	561	ğ	572	ķ
518	å	529	ð	540	ü	551	č	562	ğ	573	í
519	æ	530	ñ	541	ý	552	d'	563	h	574	ı
520	ç	531	ò	542	þ	553	đ	564	h	575	ı
521	è	532	ó	543	ß	554	ē	565	ĩ	576	ı
522	é	533	ô	544	ÿ	555	ě	566	ī	577	ł
523	ê	534	õ	545	ā	556	è	567	ĩ	578	ń



579	ŋ	604	ž	629	o	654	o	679	g	741	›
580	ň	605	ž	630	π	655	Π	680	h	742	x
581	ŋ	606	ž	631	ρ	656	ρ	681	i	743	y
582	ō	607	o'	632	σ	657	с	682	j	744	i
583	ö	608	u'	633	τ	658	т	683	k	745	j
584	õ	609	ă	634	υ	659	y	684	l	746	k
585	œ	610	ĩ	635	φ	660	φ	685	m	752	o
586	í	611	ö	636	χ	661	χ	686	n	753	1
587	ı	612	ũ	637	ψ	662	ц	687	o	754	2
588	ř	613	ũ	638	ω	663	ч	688	p	755	3
589	ś	614	ú	639	a	664	ш	689	q	756	4
590	š	615	α	640	б	665	щ	690	r	757	5
591	ş	616	β	641	в	666	ъ	691	s	758	6
592	š	617	γ	642	г	667	ы	692	t	759	7
593	ţ	618	δ	643	д	668	ь	693	u	760	8
594	ť	619	ε	644	e	669	э	694	v	761	9
595	t	620	ζ	645	ë	670	ю	695	w	762	+
596	ũ	621	η	646	ж	671	я	696	x	763	-
597	ū	622	θ	647	з	672	є	697	y	764	-1
598	ü	623	ι	648	и	673	α	698	z	765	x
599	û	624	κ	649	й	674	b	736	ş	766	y
600	ú	625	λ	650	к	675	c	737	'		
601	ц	626	μ	651	л	676	d	738	''		
602	ŵ	627	ν	652	м	677	e	739	'''		
603	ÿ	628	ξ	653	н	678	f	740	‘		

769	i	778	n	787	≥	796	≥	805	⊥	814	”
770	e	779	∠	788	±	797	с	806	≡	815	“
771	E	780	¯	789	÷	798	⊃	807	∇	816	↵
772	π	781	ȳ	790	≠	799	U	808	∇	817	▲
773	∞	782	ô	791	«	800	∩	809	Δ	818	-
774	°	783	⇒	792	»	801	L	810	∴	819	N
775	˚	784	x	793	€	802	V	811	∴	820	Z
776	˚	785	≠	794	≡	803	∇	812	‘	821	Q
777	'	786	≤	795	€	804	∧	813	'	822	R

823	Ɔ	844	ſ	864	Å	884	∥	904	◀	925	↑
824	”	845	≅	865	°C	885	¡	905	○	926	↩
825	´	846	≠	866	°F	886	【	906	◎	927	×10 <sup>x</sup>
826	`	847	∞	867	←	887	】	907	⊙	928	⚙
827	ˆ	848	√	868	↑	888	▴	908	●	929	←
828	˜	849	Σ	869	→	889	♪	909	©	930	⊕
829	°	850	∏	870	↓	890	♫	910	®	931	⊖
830	á	851	∫	871	↔	891	🔒	911	...	932	⊗
831	â	852	∫∫	872	↕	892	🔓	912	...	933	⊘
832	±	853	φ	873	↖	893	□	913	◦	934	℥
833	≈	854	∂	874	↗	894	■	914	•	935	∥
834	↔	855	¿	875	↘	895	☑	915	×	936	z̄
835	∃	856	¡	876	↙	896	♠	916	↗	937	Ā
836	€	857	¢	877	¼	897	♣	917	↘	938	Ĕ
837	ƒ	858	£	878	½	898	♥	918	↙	939	Ħ
838	ƒ	859	¥	879	¾	899	♦	919	↕	940	Q̄
839	ð	860	Fr	880	§	900	◇	920	☒	941	∞
840	đ	861	F	881	✖	901	▲	921	🔔	942	,
841	đ	862	€	882	¶	902	▶	923	●	943	j
843	z	863	f	883	○	903	▼	924	<b>CAPS</b>		

# System Variable Table

The table below shows an alphabetic listing of system variables.

- If a variable has an initial value, the value is shown inside of braces ( { } ) in the “Name” column.
- The letter to the left of the slash in the “Op” column indicates whether or not input for the variable is supported, while the letter to the right of the slash indicates whether or not the variable can be deleted (Y: Yes, N: No).

**Note:** Use the Define command to input a value for a Type “F” (FUNC) variable. For an example about how to do this, see “Define” on page 90.

- The “Type” column indicates the data type of the variable.  
Ex: EXPR, St: STR, L: LIST, M: MAT, F: FUNC, \_r: Real Number

Name	Description	Op	Type	Name	Description	Op	Type
$a_0$ {0}	Sequence variable	Y/N	Ex_r	$c_0$ {0}	Sequence variable	Y/N	Ex_r
$a_1$ {0}	Sequence variable	Y/N	Ex_r	$c_1$ {0}	Sequence variable	Y/N	Ex_r
$a_2$ {0}	Sequence variable	Y/N	Ex_r	$c_2$ {0}	Sequence variable	Y/N	Ex_r
$a$ Coef	Regression coefficient $a$	N/N	Ex_r	$c$ Coef	Regression coefficient $c$	N/N	Ex_r
$ac$ Seq	Sequence graph trace variable	N/N	Ex_r	$cc$ Seq	Sequence graph trace variable	N/N	Ex_r
$a_n$	Recursion expression variable	N/N	St	$c_n$	Recursion expression variable	N/N	St
$a_{n+1}$	Recursion expression variable	Y/Y	St	$c_{n+1}$	Recursion expression variable	Y/Y	St
$a_{n+2}$	Recursion expression variable	Y/Y	St	$c_{n+2}$	Recursion expression variable	Y/Y	St
$a_{n0}$	Recursion internal variable	N/N	Ex_r	$c_{n0}$	Recursion internal variable	N/N	Ex_r
$a_{n1}$	Recursion internal variable	N/N	Ex_r	$c_{n1}$	Recursion internal variable	N/N	Ex_r
$a_{n2}$	Recursion internal variable	N/N	Ex_r	$c_{n2}$	Recursion internal variable	N/N	Ex_r
$a_n$ E	Sequence expression	Y/Y	St	$c_n$ E	Sequence expression	Y/Y	St
$a_n$ E <sub>0</sub>	Recursion internal variable	N/N	Ex_r	$c_n$ E <sub>0</sub>	Recursion internal variable	N/N	Ex_r
angle $\theta$	Angle between line of vision and $x$ -axis of 3D Graph View Window value	Y/N	Ex_r	$c_n$ Start {0}	Sequence variable	Y/N	Ex_r
angle $\phi$	Angle between line of vision and $z$ -axis of 3D Graph View Window value	Y/N	Ex_r	ConicsEq	Conics expression	Y/Y	St
ans	Latest result output by Main or eActivity application	N/N	Ex/L/M/St	$d$ Coef	Regression coefficient $d$	N/N	Ex_r
$a_n$ Start {0}	Sequence variable	Y/N	Ex_r	$df$	Degrees of freedom	N/N	Ex_r
$b_0$ {0}	Sequence variable	Y/N	Ex_r	$df$ A	Degrees of freedom for factor A	N/N	Ex_r
$b_1$ {0}	Sequence variable	Y/N	Ex_r	$df$ AB	Degrees of freedom for factor A $\times$ Factor B	N/N	Ex_r
$b_2$ {0}	Sequence variable	Y/N	Ex_r	$df$ B	Degrees of freedom for factor B	N/N	Ex_r
$b$ Coef	Regression coefficient $b$	N/N	Ex_r	$df$ Err	Degrees of freedom for error	N/N	Ex_r
$bc$ Seq	Sequence graph trace variable	N/N	Ex_r	$e$ Coef	Regression coefficient $e$	N/N	Ex_r
$b_n$	Recursion expression variable	N/N	St	Expected	Expected matrix for $\chi^2$ test	N/N	M_r
$b_{n+1}$	Recursion expression variable	Y/Y	St	FEnd {5}	Table creation variable	Y/N	Ex_r
$b_{n+2}$	Recursion expression variable	Y/Y	St	FResult	Table result variable	N/N	M
$b_{n0}$	Recursion internal variable	N/N	Ex_r	FStart {1}	Table creation variable	Y/N	Ex_r
$b_{n1}$	Recursion internal variable	N/N	Ex_r	FStep {1}	Table creation variable	Y/N	Ex_r
$b_{n2}$	Recursion internal variable	N/N	Ex_r	Fvalue	$F$ value	N/N	Ex_r
$b_n$ E	Sequence expression	Y/Y	St	FvalueA	$F$ value for factor A	N/N	Ex_r
$b_n$ E <sub>0</sub>	Recursion internal variable	N/N	Ex_r	FvalueAB	$F$ value for factor A $\times$ factor B	N/N	Ex_r
$b_n$ Start {0}	Sequence variable	Y/N	Ex_r	FvalueB	$F$ value for factor B	N/N	Ex_r
				GconHEnd {5}	Graph transformation vertical end point	N/N	Ex_r
				GconHStart {1}	Graph transformation vertical start point	N/N	Ex_r

Name	Description	Op	Type
GconHStep {1}	Graph transformation vertical step value	N/N	Ex_r
GconWEnd {5}	Graph transformation horizontal end point	N/N	Ex_r
GconWStart {1}	Graph transformation horizontal start point	N/N	Ex_r
GconWStep {1}	Graph transformation horizontal step value	N/N	Ex_r
HStart {0}	Start value for histogram	Y/N	Ex_r
HStep {1}	Step value for histogram	Y/N	Ex_r
LInterval	Lower limit of confidence interval	N/N	Ex_r
list1	Default list	Y/Y	L
list2	Default list	Y/Y	L
list3	Default list	Y/Y	L
list4	Default list	Y/Y	L
list5	Default list	Y/Y	L
list6	Default list	Y/Y	L
maxX	Maximum value of $x$	N/N	Ex_r
maxY	Maximum value of $y$	N/N	Ex_r
MeanSA	Mean square for factor A	N/N	Ex_r
MeanSAB	Mean square for factor A $\times$ factor B	N/N	Ex_r
MeanSB	Mean square for factor B	N/N	Ex_r
MeanSErr	Mean square for error	N/N	Ex_r
MedStat	Median value	N/N	Ex_r
medx <sub>1</sub>	Medmed graph summary point	N/N	Ex_r
medx <sub>2</sub>	Medmed graph summary point	N/N	Ex_r
medx <sub>3</sub>	Medmed graph summary point	N/N	Ex_r
medy <sub>1</sub>	Medmed graph summary point	N/N	Ex_r
medy <sub>2</sub>	Medmed graph summary point	N/N	Ex_r
medy <sub>3</sub>	Medmed graph summary point	N/N	Ex_r
minX	Minimum value of $x$	N/N	Ex_r
minY	Minimum value of $y$	N/N	Ex_r
ModeFStat	Frequency of mode values	N/N	Ex_r
ModeNStat	Number of mode values	N/N	Ex_r
ModeStat	Mode value	N/N	L_r
MSe	Mean square error for regression	N/N	Ex_r
n <sub>1</sub> Stat	Size of sample 1	N/N	Ex_r
n <sub>2</sub> Stat	Size of sample 2	N/N	Ex_r
ncSeq	Sequence graph trace variable	N/N	Ex_r
nSeq	Sequence variable	N/N	Ex_r
nStat	Sample size	N/N	Ex_r
Observed	Observed matrix for $\chi^2$ test	N/N	M_r
$\hat{p}$	Estimated proportion	N/N	Ex_r
$\hat{p}_1$	Estimated proportion of sample 1	N/N	Ex_r
$\hat{p}_2$	Estimated proportion of sample 2	N/N	Ex_r
<i>prob</i>	$p$ -value	N/N	Ex_r

Name	Description	Op	Type
<i>probA</i>	$p$ -value of factor A	N/N	Ex_r
<i>probAB</i>	$p$ -value of factor A $\times$ factor B	N/N	Ex_r
<i>probB</i>	$p$ -value of factor B	N/N	Ex_r
<i>py1(x) - py5(x)</i>	Picture Plot function expression	Y/Y	F
Q <sub>1</sub> Stat	First quartile point	N/N	Ex_r
Q <sub>3</sub> Stat	Third quartile point	N/N	Ex_r
<i>r1(θ) - r100(θ)</i>	Graph expression input variable, $r=$ type	Y/Y	F
<i>r<sup>2</sup>Corr</i>	Coefficient of determination	N/N	Ex_r
randResult {-1}	Internal variable used for next random-number calculation	N/N	Ex_r
<i>rc</i> {0}	Graph coordinate value storage variable	N/N	Ex_r
<i>rCorr</i>	Correlation coefficient	N/N	Ex_r
residual	Residual data storage list	N/N	L_r
Seed {0}	Random seed value	N/N	Ex_r
<i>smax3D</i>	3D Graph View Window display $s$ maximum value	Y/N	Ex_r
<i>smin3D</i>	3D Graph View Window display $s$ minimum value	Y/N	Ex_r
<i>s<sub>p</sub></i>	Pooled sample standard deviation	N/N	Ex_r
SqEnd {5}	Sequence creation variable	Y/N	Ex_r
SqResult	Sequence result variable	N/N	M
SqStart {1}	Sequence creation variable	Y/N	Ex_r
Sres11	Statgraph1 calculation result	N/N	L_r
Sres12	Statgraph1 calculation result	N/N	L_r
Sres21	Statgraph2 calculation result	N/N	L_r
Sres22	Statgraph2 calculation result	N/N	L_r
Sres31	Statgraph3 calculation result	N/N	L_r
Sres32	Statgraph3 calculation result	N/N	L_r
Sres41	Statgraph4 calculation result	N/N	L_r
Sres42	Statgraph4 calculation result	N/N	L_r
Sres51	Statgraph5 calculation result	N/N	L_r
Sres52	Statgraph5 calculation result	N/N	L_r
Sres61	Statgraph6 calculation result	N/N	L_r
Sres62	Statgraph6 calculation result	N/N	L_r
Sres71	Statgraph7 calculation result	N/N	L_r
Sres72	Statgraph7 calculation result	N/N	L_r
Sres81	Statgraph8 calculation result	N/N	L_r
Sres82	Statgraph8 calculation result	N/N	L_r
Sres91	Statgraph9 calculation result	N/N	L_r
Sres92	Statgraph9 calculation result	N/N	L_r
sStat	Standard error value for Linear Reg $t$ -Test calculation	N/N	Ex_r
SumSA	Sum of squares for factor A	N/N	Ex_r

Name	Description	Op	Type
SumSAB	Sum of squares for factor A $\times$ factor B	N/N	Ex_r
SumSB	Sum of squares for factor B	N/N	Ex_r
SumSErr	Sum of squares for error	N/N	Ex_r
$s_x$	Sample standard deviation of $x$	N/N	Ex_r
$s_{x1}$	Sample standard deviation of data 1	N/N	Ex_r
$s_{x2}$	Sample standard deviation of data 2	N/N	Ex_r
$s_y$	Sample standard deviation of $y$	N/N	Ex_r
$t_c \{0\}$	Graph coordinate value storage variable	N/N	Ex_r
$t_{Lower}$	Result of TCD calculation	N/N	Ex_r
$t_{max3D}$	3D Graph View Window display $t$ maximum value	Y/N	Ex_r
$t_{min3D}$	3D Graph View Window display $t$ minimum value	Y/N	Ex_r
$t_{Upper}$	Result of TCD calculation	N/N	Ex_r
$T_{value}$	$t$ value	N/N	Ex_r
$t\theta_{max} \{2\pi\}$	View Window $t\theta$ Max value	Y/N	Ex_r
$t\theta_{min} \{0\}$	View Window $t\theta$ Min value	Y/N	Ex_r
$t\theta_{Step} \{\pi/60\}$	View Window $t\theta$ Step value Variable	Y/N	Ex_r
UInterval	Upper limit of confidence interval	N/N	Ex_r
$\bar{x}$	Mean of $x$	N/N	Ex_r
$\bar{x}_1$	Mean of data 1	N/N	Ex_r
$x1(y) - x100(y)$	Graph expression input variable, $x=$ type	Y/Y	F
$x_1InvN$	Result of InvNorm calculation	N/N	Ex_r
$\bar{x}_2$	Mean of data 2	N/N	Ex_r
$x_2InvN$	Result of InvNorm calculation	N/N	Ex_r
$x_c \{0\}$	Graph coordinate value storage variable	N/N	Ex_r
$x_{dot} \{0.1\}$	View Window 1-dot $x$ -axis value	Y/N	Ex_r
$x_{fact} \{2\}$	Factor zoom $x$ -factor value	Y/N	Ex_r
$x_{grid3D}$	3D Graph View Window value	Y/N	Ex_r
$x_{Inv}$	Result of inverse cumulative distribution calculations	N/N	Ex_r
$x_{max} \{7.7\}$	View Window display range $x$ -axis maximum value	Y/N	Ex_r
$x_{max3D}$	3D Graph View Window display range $x$ -axis maximum value	Y/N	Ex_r
$x_{min} \{-7.7\}$	View Window display range $x$ -axis minimum value	Y/N	Ex_r
$x_{min3D}$	3D Graph View Window display range $x$ -axis minimum value	Y/N	Ex_r
$x_{scl} \{1\}$	View Window display range $x_{scale}$	Y/N	Ex_r

Name	Description	Op	Type
$xt1(t) - xt100(t)$	Graph expression input variable, parametric type	Y/Y	F
$\bar{y}$	Mean of $y$	N/N	Ex_r
$y1(x) - y100(x)$	Graph expression input variable, $y=$ type	Y/Y	F
$y_c \{0\}$	Graph coordinate value storage variable	N/N	Ex_r
$y_{dot} \{0.1\}$	View Window 1-dot $y$ -axis value	Y/N	Ex_r
$y_{fact} \{2\}$	Factor zoom $y$ -factor value	Y/N	Ex_r
$y_{grid3D}$	3D Graph View Window value	Y/N	Ex_r
$y_{max} \{3.8\}$	View Window display range $y$ -axis maximum value	Y/N	Ex_r
$y_{max3D}$	3D Graph View Window display range $y$ -axis maximum value	Y/N	Ex_r
$y_{min} \{-3.8\}$	View Window display range $y$ -axis minimum value	Y/N	Ex_r
$y_{min3D}$	3D Graph View Window display range $y$ -axis minimum value	Y/N	Ex_r
$y_{scl} \{1\}$	View Window display range $y_{scale}$	Y/N	Ex_r
$yt1(t) - yt100(t)$	Graph expression input variable, parametric type	Y/Y	F
$z1(x,y) - z100(x,y)$	3D Graph function expression	Y/Y	F
$z_c \{0\}$	Graph coordinate value storage variable	N/N	Ex_r
$z_{Lower}$	Result of NormCD calculation	N/N	Ex_r
$z_{max3D}$	3D Graph View Window display range $z$ -axis maximum value	Y/N	Ex_r
$z_{min3D}$	3D Graph View Window display range $z$ -axis minimum value	Y/N	Ex_r
$z_{Upper}$	Result of NormCD calculation	N/N	Ex_r
$Z_{value}$	$z$ value	N/N	Ex_r
$\theta_c \{0\}$	Graph coordinate value storage variable	N/N	Ex_r
$\Sigma x$	Sum of $x$	N/N	Ex_r
$\sigma x$	Population standard deviation of $x$	N/N	Ex_r
$\Sigma x^2$	Sum of $x^2$	N/N	Ex_r
$\Sigma xy$	Sum of $xy$ data	N/N	Ex_r
$\Sigma y$	Sum of $y$	N/N	Ex_r
$\sigma y$	Population standard deviation of $y$	N/N	Ex_r
$\Sigma y^2$	Sum of $y^2$	N/N	Ex_r
$\chi^2_{value}$	$\chi^2$ value	N/N	Ex_r

# Graph Types and Executable Functions

○: Executable    -: Not executable

Function \ Graph Type	y=	r=	x!=	x=	y Inequality	x Inequality	y◆	Conics* <sup>1</sup>	Stat - Plot* <sup>2</sup>	Stat - Reg* <sup>3</sup>	Stat - Box* <sup>4</sup>
Zoom - Box	○	○	○	○	○	○	○	○	○	○	○
Zoom - In	○	○	○	○	○	○	○	○	○	○	○
Zoom - Out	○	○	○	○	○	○	○	○	○	○	○
Zoom - Auto	○	○	○	○	○	○	○	○	-	-	-
Zoom - Original	○	○	○	○	○	○	○	○	○	○	○
Zoom - Square	○* <sup>5</sup>	○* <sup>5</sup>	○* <sup>5</sup>	○* <sup>5</sup>	○* <sup>5</sup>	○* <sup>5</sup>	○* <sup>5</sup>	○* <sup>5</sup>	○* <sup>5</sup>	○* <sup>5</sup>	○* <sup>5</sup>
Zoom - Round	○* <sup>6</sup>	○* <sup>6</sup>	○* <sup>6</sup>	○* <sup>6</sup>	○* <sup>6</sup>	○* <sup>6</sup>	○* <sup>6</sup>	○* <sup>6</sup>	○* <sup>6</sup>	○* <sup>6</sup>	○* <sup>6</sup>
Zoom - Integer	○* <sup>6</sup>	○* <sup>6</sup>	○* <sup>6</sup>	○* <sup>6</sup>	○* <sup>6</sup>	○* <sup>6</sup>	○* <sup>6</sup>	○* <sup>6</sup>	○* <sup>6</sup>	○* <sup>6</sup>	○* <sup>6</sup>
Zoom - Previous	○	○	○	○	○	○	○	○	○	○	○
Zoom - Initialize / Quick types	○* <sup>6</sup>	○* <sup>6</sup>	○* <sup>6</sup>	○* <sup>6</sup>	○* <sup>6</sup>	○* <sup>6</sup>	○* <sup>6</sup>	○* <sup>6</sup>	○* <sup>6</sup>	○* <sup>6</sup>	○* <sup>6</sup>
Analysis - Trace	○	○	○	○	○	○	○	○	○	○	○
Analysis - Sketch - Cls	○	○	○	○	○	○	○	○	○	○	○
Analysis - Sketch - Plot	○	○	○	○	○	○	○	○	○	○	○
Analysis - Sketch - Line	○* <sup>6</sup>	○* <sup>6</sup>	○* <sup>6</sup>	○* <sup>6</sup>	○* <sup>6</sup>	○* <sup>6</sup>	○* <sup>6</sup>	○* <sup>6</sup>	○* <sup>6</sup>	○* <sup>6</sup>	○* <sup>6</sup>
Analysis - Sketch - Text	○	○	○	○	○	○	○	○	○	○	○
Analysis - Sketch - Tangent	○	○	○	○	○	○	○	-	-	○	-
Analysis - Sketch - Normal	○	○	○	○	○	○	○	-	-	○	-
Analysis - Sketch - Inverse	○	-	-	○	-	-	-	-	-	○	-
Analysis - Sketch - Circle	○* <sup>6</sup>	○* <sup>6</sup>	○* <sup>6</sup>	○* <sup>6</sup>	○* <sup>6</sup>	○* <sup>6</sup>	○* <sup>6</sup>	○* <sup>6</sup>	○* <sup>6</sup>	○* <sup>6</sup>	○* <sup>6</sup>
Analysis - Sketch - Vertical	○	○	○	○	○	○	○	○	○	○	○
Analysis - Sketch - Horizontal	○	○	○	○	○	○	○	○	○	○	○
Analysis - G-Solve - x-Cal/y-Cal - x-Cal	○	○	-	-	○	-	-	○	-	-	-
Analysis - G-Solve - x-Cal/y-Cal - y-Cal	○	○	○	-	○	-	-	○	-	-	-
Analysis - G-Solve - Root	○	-	-	-	○	-	-	-	-	-	-
Analysis - G-Solve - Min / Max	○	-	-	-	○	-	-	-	-	-	-
Analysis - G-Solve - fMin / fMax	○	-	-	-	○	-	-	-	-	-	-
Analysis - G-Solve - y-Intercept	○	-	-	-	○	-	-	○	-	-	-
Analysis - G-Solve - Intersection	○	-	-	-	○	-	-	-	-	-	-
Analysis - G-Solve - Integral - $\int dx$	○* <sup>6</sup>	-	-	-	-	-	-	-	-	-	-
Analysis - G-Solve - Integral - Root	○* <sup>6</sup>	-	-	-	-	-	-	-	-	-	-
Analysis - G-Solve - Integral - Intersection	○* <sup>6</sup>	-	-	-	-	-	-	-	-	-	-
Analysis - G-Solve - Inflection	○	-	-	-	○	-	-	-	-	-	-
Analysis - G-Solve - Distance	○	○	○	○	○	○	○	-	-	-	-
Analysis - G-Solve - $\pi \int f(x)^2 dx$	○* <sup>6</sup>	-	-	-	-	-	-	-	-	-	-
Analysis - Modify	○	-	-	-	-	-	-	-	-	○	-
◆ - Dynamic Graph (Dynamic Modify)	○	○	○	○	○	○	○	-	-	-	-

\*1 The special conics graph G-Solve commands below can be used when drawing a conics graph.

Focus, Vertex, Directrix, Symmetry, Latus Rectum Length, Center, Radius, Asymptotes, Eccentricity, x-Intercept

\*2 The following statistical graphs: Scatter, Histogram, xyLine, Broken, NPPlot

\*3 The following statistical graphs: NDist, LinearR, MedMed, QuadR, CubicR, QuartR, LogR, ExpR, abExpR, PowerR, SinR, LogisticR

\*4 The following statistical graphs: MedBox, ModBox

\*5 Cannot be executed during semi-log graph drawing (when a graph is drawn while either the x-log or y-log check box only is selected on the View Window dialog box).

\*6 Cannot be executed during semi-log graph or log-log graph drawing (when a graph is drawn while either the x-log or y-log check box is selected or when both check boxes are selected on the View Window dialog box).

# Error and Warning Message Tables

## Error Message Table

Error Message	Description
Access to Flash ROM	–
Argument must be a variable name	Variable argument specification is wrong. Use a variable as the argument of the variable.
Main Memory is low on free space. Please delete unwanted data in Main Memory to ensure saving new data is possible.	There is not enough memory available to edit a file you are attempting to open from with the calculator application you are currently using. Though file editing is still possible, you may not be able to save your file edits. It is recommended that you use Variable Manager to delete unneeded data before editing a file.
Cannot save changes. Tap MEM to view memory usage or OK to exit without saving.	There is not enough memory to save an edited file. Tapping [MEM] on this dialog box will display Variable Manager, which you can use to delete unneeded data. Closing Variable Manager after deleting data will return to the file you are editing so you can save it. To return to the application menu without saving the file, tap [OK] on the error message dialog box.
Circular Reference	Circular reference exists for a variable.
Compressed programs cannot be edited.	The file is compressed. Use the uncompressed version of the file for editing.
Current Folder	You attempted to perform an operation that is prohibited for the current folder.
Delete or store operation is invalid for program/function type	–
Division by 0	–
Domain	An argument value is outside of the specified Domain range.
Exceeds Maximum Length of Line	A line in your program exceeds the allowable length.
Exceeds Maximum Number of Folders	Number of user folders exceeded the allowable maximum during the Open process. User folders are any folders used for main memory Variables.
Exceeds Maximum Number of Variables	The operation you are attempting creates variables that cause the maximum number of allowable variables to be exceeded.
Exception Error Occurred	–
Export failed.	Error generated during export causing abnormal export end.
File System ERROR	A file system error occurred.
Flash ROM! Initialize Flash ROM immediately at System application!	–
Folder	The folder name you specified for a command argument does not exist. Or you have input the name of a folder that cannot be specified (“library” folder, etc.)
Function has invalid variable name	–

<b>Error Message</b>	<b>Description</b>
Function Type	The expression type that is selected cannot execute a function.
History Full	The operation you are performing creates a history entry that causes history contents to exceed the allowable limit.
Import failed.	Error generated during import causing abnormal import end.
Incorrect Argument	–
Incorrect Jump	A “Goto” command is used without a corresponding “Lbl” command.
Incorrect Number of Arguments	–
Incorrect Number of Parenthesis	–
Incorrect Program Call	–
Insufficient Elements	–
Insufficient Memory	There is not enough memory to complete the operation you are trying to perform. <b>Note:</b> Also refer “The calculation result cannot be displayed....” (page 306).
Insufficient Storage Memory	Insufficient available capacity in the storage area.
Invalid Boundary	The specified boundary conditions are not appropriate for the operation being performed.
Invalid Code	–
Invalid Data Size	You attempted to import a CSV file whose number of rows and/or columns caused the application’s allowable memory capacity to be exceeded.
Invalid Data Type	<ul style="list-style-type: none"> <li>• The calculation you are trying to perform has an invalid data type as an argument.</li> <li>• You are attempting to import or open an invalid file type.</li> </ul>
Invalid Dimension	The two lists or matrices you are trying to perform a calculation between have different dimensions.
Invalid file or folder name.	Folder, file, or path name is too long, so the folder or file cannot be created in the mass storage area.
Invalid for Local Variable	You attempted to perform an operation that is prohibited for a local variable.
Invalid in a Function or Current Expression	You are trying to perform a calculation using an expression that contains an illegal command (or function).
Invalid Name	You are trying to use an improper folder name, variable name (including functions and programs), or label name.
Invalid Outside Function or Program	You are trying to execute a command that must be used inside of a program as a local command, outside of a program.
Invalid Path	You are trying to specify an invalid path. This error occurs when you include a system folder in a path, when you include a system variable in a path, or when you try to specify a path where path specification is not allowed.

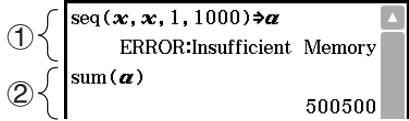

<b>Error Message</b>	<b>Description</b>
Invalid String	The command you are trying to execute has an invalid string specified as an argument.
Invalid Syntax	The syntax you are trying to use is not correct.
Invalid Table Input Value	You attempted to create a number table with more than 9999 rows with the Graph & Table application or Interactive Differential Calculus application.
Invalid Variable Reference	The variable you are trying to access does not exist. This error occurs when you try to read the contents of a system variable that does not contain any data, etc.
Invalid View Window Value	–
Locked or Protected	–
Maximum value needs to be larger than minimum	–
Memory is full	Memory has become full during a data communication operation.
Nesting of subroutines exceeds 40 levels	–
No file is specified	–
No Sequences Selected	–
No Sheet Name	–
No Solution	–
No Stat Graphs Selected	–
No Variable	–
No word is specified	–
Non-Algebraic Variable in Expression	You are attempting to use a variable that cannot be used in a calculation.
Non-Real in Calc	The ClassPad is in the Real mode but the value you are inputting or the result produced by a calculation is a complex number.
Not a Local Variable	The variable you are trying to assign data to is not a local variable.
Not a Numerical Value Result	–
Not an Empty Folder	You are trying to delete or perform some other operation on a folder that is not empty.
Not Appropriate Numerical Value Input	–
Not Found	–
Not Function Name or Program Name	–
Over 30 factors have occurred	The number of factors in a summary table has exceeded 30.
Overflow	–
Page Size	–
Receiving Failure	–
Reserved Name or System Variable	–

Error Message	Description
The calculation result cannot be displayed. The result can be assigned to a variable using Calculation $\Rightarrow$ Variable. For example Seq ( $x, x, 1, 999$ ) $\Rightarrow$ list1	<p>The number of horizontal dots for the result of a calculation that uses the Main or eActivity application exceeds 32,787 (approximately 2,500 single-byte characters).</p> <p><b>Example:</b> Executing the calculation seq(<math>x, x, 1, 1000</math>), whose calculation result produces a list of 1,000 elements {1, 2, 3 ... 1000}. Though the calculation result cannot be displayed when this error occurs, you may be able to use the <math>\Rightarrow</math> command to assign the result to a variable and use that variable in a calculation.</p> <p><b>Example:</b></p>  <p>① Assigns the calculation result of seq(<math>x, x, 1, 1000</math>) to variable <math>a</math> (even though the result cannot be displayed).</p> <p>② sum(<math>a</math>) can be used to obtain the total of the list generated by seq(<math>x, x, 1, 1000</math>).</p>
This function is disabled in Exam Mode.	—
Though you can continue this operation, you will not be able to save data because of insufficient memory. Delete unnecessary data from memory.	<p>There is not enough memory available to edit a file you are attempting to open from with the calculator application you are currently using, or you cannot save the file after editing it.</p> <p>Use Variable Manager to delete unneeded data before editing a file.</p>
Too Long String	—
Transmission Failure	—
Undefined Result in Condition Judgment	A condition judgment program control command has performed comparison with an undefined variable, which returns a condition judgment of “Undefined”.
Undefined Variable	—
Variable in Use	—
View Window settings for log contain a 0 or negative value.	—
View Window value is out of range	—
Wrong Argument Type	—

---

## Warning Message Table

Warning Message	Description
Batteries are extremely low! Replace batteries immediately!	—
Can't Solve!	—
Can't solve! Adjust initial value or bounds. Then try again.	NumSolve cannot solve an expression.
Insufficient memory for unit-to-unit communication. Delete unnecessary eActivity contents.	—
Only the first selected function will be done.	—
Time out. The end of condition was not satisfied.	—
Too Many eActivity Files	The data communication operation you are trying to perform is not possible because there are too many eActivity files.

---

## Low Memory Error Processing

An error occurs on the ClassPad if it is unable to reserve enough work area memory to perform a particular operation. When a low memory error occurs, any application in use at that point is shut down and an error message like the one shown below appears.

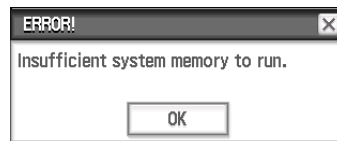

Tapping the [OK] button clears the error.

### **Important!**

- To avoid loss of data, you should make it a regular habit to periodically perform the save operation.

You may lose some of the data you are inputting with an application that shuts down due to a low memory error. When the low memory error occurs while you are using the eActivity application to create data, for example, any unsaved data you have input is lost.

## Resetting and Initializing the ClassPad

The memory of your ClassPad is divided into four parts: main memory, a storage area for storing data, an eActivity area, and a RAM area for executing various calculations and operations. Reset and initialize restore normal ClassPad operation after some problem occurs.

**RAM Reset:** Perform RAM reset when the ClassPad freezes up or otherwise fails to perform as expected for some reason. A RAM reset does not affect data stored in main memory, the storage area, or the eActivity area, but it clears any data stored in the RAM area.

**Memory Reset:** There are four different types of memory reset operations. Deleting all variable and program data in main memory, deleting all eActivity data, deleting all data in the storage area, deleting all three of the above.

**Memory Initialize:** Memory Initialize deletes all data in ClassPad memory and returns all settings to their initial factory defaults.

This section explains how to perform the RAM reset operations only. The memory reset and memory initialize operations are performed using the System application. For details, see "18-2 Configuring System Settings".

## • To perform the RAM reset operation

### **Important!**

- The RAM reset operation deletes all data that is temporarily stored in ClassPad RAM. Performing the RAM reset operation while a calculation is in progress will cause any data stored in RAM by the calculation to be lost.
- Perform the RAM reset operation only when your ClassPad freezes up or when it begins to operate abnormally for some reason.

1. Use the stylus to press the RESTART button on the back of the ClassPad.

- Following the RAM reset operation, the ClassPad restarts automatically.

2. After the ClassPad restarts, perform the ClassPad setup operation. For more information about the setup operation, see “Loading Batteries and Setting Up the ClassPad” in the separate Quick Start Guide.

- The application menu appears after you finish the setup operation.

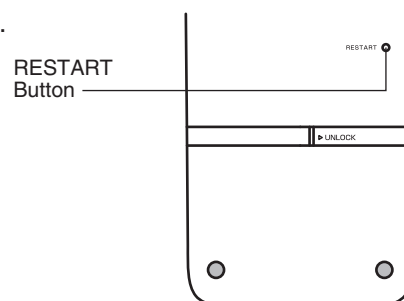

## Number of Digits and Precision

### Number of Digits

#### Standard Mode

The following applies when the check box next to the “Decimal Calculation” item on the Basic Format dialog box is not selected.

- Up to 611 digits are stored in memory for integer values.
- Decimal values up to 15 digits are converted to fraction format and saved in memory. When a mathematical expression cannot be converted to fraction format, the result is displayed in decimal format.
- Values stored in memory are displayed as-is, regardless of how [Number Format] settings (Normal 1, Normal 2, Fix 0 to Fix 9, Sci 0 to Sci 9) are configured (except when a decimal value is displayed).

#### Decimal Mode

The following applies when the check box next to the “Decimal Calculation” item on the Basic Format dialog box is selected.

- Values stored in Ans memory and values assigned to variables have the same number of digits as defined for Standard mode values.
- Values are displayed in accordance with how [Number Format] settings (Normal 1, Normal 2, Fix 0 to Fix 9, Sci 0 to Sci 9) are configured.
- Displayed values are rounded to the appropriate number of decimal places.
- Some applications store values using a mantissa up to 15 digits long and a 3-digit exponent.

### Precision

- Internal calculations are performed using 15 digits.
- The error for a single mathematical expression (Decimal mode calculation error) is  $\pm 1$  at the 10th digit. In the case of exponential display, calculation error is  $\pm 1$  at the least significant digit. Note that performing consecutive calculations causes error to be cumulative. Error is also cumulative for internal consecutive calculations performed for:  $\wedge(x^y)$ ,  $\sqrt[x]{y}$ ,  $x!$ ,  $nPr$ ,  $nCr$ , etc.
- Error is cumulative and tends to be larger in the vicinity of a function’s singular point(s) and inflection point(s), and the vicinity of zero. With  $\sinh(x)$  and  $\tanh(x)$ , for example, the inflection point occurs when  $x = 0$ . In this vicinity, error is cumulative and precision is poor.

# Display Brightness and Battery Life

---

## Display Brightness

The display brightness of your ClassPad is adjustable. The initial default brightness setting after purchase is “Medium”. Display brightness will dim automatically if you do not perform any operation for about 30 seconds. Performing an operation will cause display brightness to return to normal.

For details about how to configure the display brightness setting, see “Chapter 18: System Application”.

---

## Battery Life

Battery life is affected by the display brightness and backlight duration settings. Battery life is also affected by how the ClassPad is used. Using a program to execute a long series of calculations, for example, will shorten battery life.

ClassPad Operation	Display Brightness	Batteries	Approximate Battery Life* <sup>1</sup>
Repeat of following three-step cycle each hour.	Display brightness settings during each of the three steps described to the left.	Alkaline	100 hours
(1) Application Menu display for 5 minutes	(1) Initially “Medium”, dimmed after 30 seconds	Nickel-metal hydride (recommended type only)	60 hours
(2) Program application calculation for 5 minutes	(2) “Medium”		
(3) Program application display for 50 minutes	(3) Same as (1), above.		

\*<sup>1</sup> New alkaline batteries or fully-charged new nickel-metal hydride batteries, in an ambient temperature of 25°C. Battery life values are approximate and are intended for reference only.

## Specifications

**Calculation range:**  $\pm 1 \times 10^{-999}$  to  $\pm 9.999999999 \times 10^{999}$  and 0.

Internal operations use 15-digit mantissa in the case of calculations that do not use algebraic methods (calculations with Newton’s Method, for example)

**Maximum allowable range for rounding of calculation results:**  $-9.5^{999} < x < -9.5^{-308}$ ,  $1.0^{-308} < x < 9.5^{999}$

**Exponential display range:** Normal 1:  $10^{-2} > |x|$ ,  $|x| \geq 10^{10}$ , Normal 2:  $10^{-9} > |x|$ ,  $|x| \geq 10^{10}$

**Program capacity:** 500 KB (max.)

**Storage memory capacity:** 5.5 MB (max.) for the eActivity area  
24 MB (max.) for the storage area

**Power supply:** Four AAA-size batteries LR03 (AM4), or four nickel-metal hydride batteries

**Power consumption:** 1.0 W

**Approximate battery life:**

Battery life values shown below are based on use of new alkaline batteries or fully-charged new nickel-metal hydride batteries, in an ambient temperature of 25°C, and depend on the operating conditions ((a), (b), or (c)).

(a) Continuous display in the Program application, each hour starting with “Medium” display brightness, dimmed automatically after 30 seconds

- (b) Repeat of ①, ②, ③ sequence below each hour:
- ① Application Menu display for 5 minutes  
Start of display at “Medium” display brightness, dimmed automatically after 30 seconds
  - ② Program application calculation for 5 minutes  
“Medium” display brightness
  - ③ Program application display for 50 minutes  
Display brightness same as ①, above.
- (c) Power off

Batteries	Condition (a)	Condition (b)	Condition (c)
Four AAA-size alkaline batteries LR03 (AM4)	170 hours	100 hours	1 year
Four nickel-metal hydride batteries (recommended type only)	100 hours (Reference)	60 hours (Reference)	–

- The conditions below can greatly reduce battery life.
  - Continuous program calculation execution
  - Battery manufacturer and type, differences between individual batteries
  - Operating conditions (applications used)
  - ClassPad settings (display brightness setting, backlight duration setting, etc.)

**Auto power off:** Power is automatically turned off if no operation is performed for a specified period (user-settable as approximately 10 minutes or approximately 60 minutes). The initial default setting is approximately 10 minutes.

**Ambient temperature range:** 0°C to 40°C (32°F to 104°F)

**Dimensions:** 21.1 mm (H) × 89 mm (W) × 206 mm (D), 7/8" (H) × 3 1/2" (W) × 7 1/2" (D)

**Weight:** Approx. 315 g (11.1 oz) (including batteries)

**Data communication:**

**Port:** 3-pin data communication port, 4-pin mini USB port

**Method:** Start-stop (asynchronous), full-duplex

**Transmission speed (BPS):** 115200, 38400, 9600 bits/second (normal)  
38400 bits/second (Send38k/Receive38k)

**Parity:** None

**Bit length:** 8 bits

**Stop bit:** Send38k: 2 bits, Receive38k: 1 bit

**Flow control:** X ON

# Exam Mode

The Exam Mode puts some limits on ClassPad functions, which allows it to be used when taking an exam or test. Use the Exam Mode only when actually taking an exam or test.

Entering the Exam Mode affects ClassPad operation as described below.

- The following applications and functions are disabled: eActivity, Picture Plot, E-CON3, Program, data transfer, add-in applications, storage memory access, user name editing, resetting, OS Update.
- User data (main memory) is backed up. The backed up data will be restored when you exit the Exam Mode. Any data created during an Exam Mode session will be deleted when the Exam Mode is exited.

---

## Communication Application - Exam Mode Menu

The Communication application displays the Exam Mode menus shown below in the menu bar.

- Enter the Exam Mode ..... Exam - Enter Exam Mode
- Unlock the Exam Mode ..... Exam - Unlock Exam Mode
- Display elapsed time in Exam Mode ..... Exam - Elapsed Time\*
- Display Exam Mode Help ..... Exam - Help

\* Entering the Exam Mode displays this menu.

---

## Entering the Exam Mode

There are two ways to enter the Exam Mode.

(1) Using the keypad

1. Press **[Shift]** **[Clear]** to turn off the ClassPad.
2. While holding down the **[Y]** and **[Z]** keys, also hold down the **[Clear]** key until the dialog box shown nearby appears.

### Note

The dialog box may not appear if you release the three keys too soon. If this happens, perform the above procedure from step 1 again.

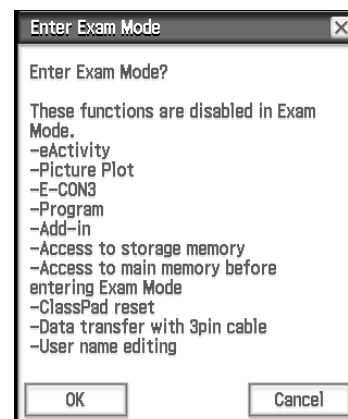

3. Tap [OK].
  - Read the message on the dialog box that appears.
4. Tap [OK].
  - This displays the dialog box shown nearby, indicating that the ClassPad entered the Exam Mode.

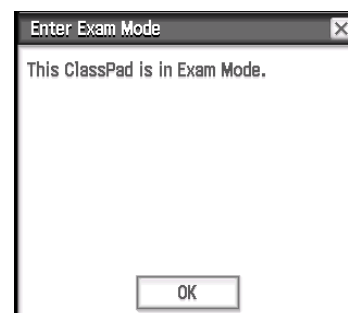





5. Tap [OK].

## (2) Using the Communication application

1. On the application menu, tap .
  2. Tap [Exam] and then [Enter Exam Mode].
  3. Perform steps 3 through 5 under “(1) Using the keypad”.
- Only the settings below are saved before entering the Exam Mode.  
Basic Format: Number Format, Angle, Complex Format, Decimal Calculation, Assistant, Descending Order, Variable is Real,  $Q_1$ ,  $Q_3$  on Data  
Geometry Format: Number Format, Length Unit, Measure Angle, Function Angle  
Advanced Format: Transform Definition, FFT Scaling Constant, Assume positive real  
System setting: Battery Settings, Language, Imaginary Unit, Keyboard, Touch Panel Alignment
  - Entering the Exam Mode causes the [Cable Type] setting of the Communication application to be fixed as “3pin cable”.

---

## ClassPad Operation in the Exam Mode

- The battery level indicator will change to . The battery level indicator will remain green () for about 15 minutes after you enter the Exam Mode. After that, it will change to blue ().
- Use the procedure below to display the elapsed time in the Exam Mode.
  1. On the application menu, tap .
  2. Tap [Exam] and then [Elapsed Time].



You can restart the elapsed time count by performing one of the operations below.

- Press the RESTART button.
  - Remove the calculator's batteries.
  - Re-enter the Exam Mode while already in the Exam Mode.
- The table below shows how certain operations affect the Exam Mode.

If you do this:	The ClassPad stays in Exam Mode.	Data input in Exam Mode is retained.
Turn power off and then back on again	Yes	Yes
Press the RESTART button	Yes	No
Remove the ClassPad's batteries	Yes	No



---

## Exiting the Exam Mode

There are three ways to exit the Exam Mode.

### (1) Exiting the Exam Mode by Connecting to a Computer

1. Use the USB cable to connect the ClassPad that is in the Exam Mode to a computer.
  - The ClassPad will turn on automatically and the Select Connection Mode dialog box will appear.
2. Tap [USB Flash].
3. On the computer, open the ClassPad drive.
  - The ClassPad drive represents the ClassPad's storage area.
4. On the computer, copy or delete any file that is on the ClassPad drive.
5. Terminate the connection between the ClassPad and computer.
  - The dialog box shown nearby will appear when you exit the Exam Mode.

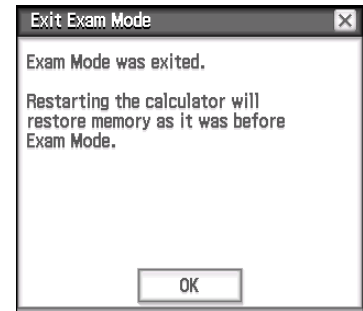

### (2) Exiting the Exam Mode by Allowing 12 Hours to Elapse

Approximately 12 hours after entering the Exam Mode, turning on the calculator will cause it to exit the Exam Mode automatically.

#### **Important!**

If you press the RESTART button or if you replace batteries before turning on the calculator, it will re-enter the Exam Mode when turned on, even if 12 hours have elapsed.

### (3) Exiting the Exam Mode by Connecting to another ClassPad

1. On the ClassPad that is in the Exam Mode (ClassPad A), enter the Communication application and then tap [Link] - [Receive].
2. Use the SB-62 cable to connect ClassPad A to another ClassPad that is not in the Exam Mode (ClassPad B).

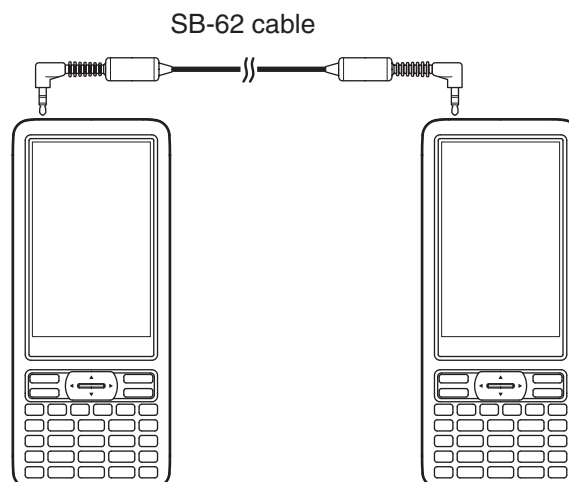

3. On ClassPad B\*, enter the Communication application and then tap [Exam] - [Unlock Exam Mode] - [OK].

- You could also transfer any data from ClassPad B to ClassPad A.

**Example:** To transfer setup data to ClassPad A

1. On ClassPad B, enter the Communication application.
2. Tap [Setup] - [Open Setup Menu].

3. Tap the [Cable Type] down arrow button, and then select [3pin cable].
4. Tap [Set].
5. Tap [Link] - [Transmit].
6. Tap [View] - [Application Status].
7. Select the check box next to the "Setup".
8. Tap [OK].
9. In response to the confirmation message that appears, tap [OK].

\* ClassPad with Exam Mode function

- Exiting the Exam Mode will cause the battery level indicator to change back to .

---

## Displaying Exam Mode Help

You can display Exam Mode help in the Communication application.

1. On the application menu, tap .
2. Tap [Exam] and then [Help].



Manufacturer:

CASIO COMPUTER CO., LTD.

6-2, Hon-machi 1-chome, Shibuya-ku, Tokyo 151-8543, Japan

Responsible within the European Union:

Casio Europe GmbH

Casio-Platz 1, 22848 Norderstedt, Germany

[www.casio-europe.com](http://www.casio-europe.com)

**CASIO®**

**CASIO COMPUTER CO., LTD.**

6-2, Hon-machi 1-chome  
Shibuya-ku, Tokyo 151-8543, Japan

One or more of the following patents may be used in the product.  
U.S.Pats. 8,576,230 8,817,027